

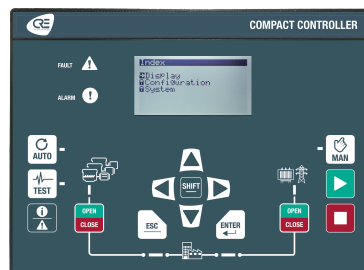

OPERATOR MANUAL

MASTER COMPACT



CRE TECHNOLOGY
Zone des Templiers - SOPHIA ANTIPOLIS
130 allée Charles-Victor Naudin
06410 BIOT - FRANCE
Phone: +33 (0)4.92.38.86.82
www.cretechnology.com
info@cretechnology.com

COPYRIGHT © CRE TECHNOLOGY. ALL RIGHTS RESERVED

TABLE OF CONTENTS

LIST OF FIGURES.....	4
DESCRIPTION.....	6
Front face.....	6
Rear face.....	9
Panel mounting.....	10
UL requirements.....	12
USAGE.....	14
Password.....	14
LCD.....	15
Wiring.....	17
Digital inputs.....	24
Digital/Relays outputs.....	26
Analog inputs.....	27
Hysteresis (digital input).....	32
Hysteresis.....	33
SETTINGS.....	35
Circuit breakers.....	35
Synchronization.....	40
Load/Unload ramp.....	43
kW/kVAR regulation.....	44
Protections.....	45
Events.....	49
Control loop PID.....	51
ADVANCED SETTINGS.....	52
Static paralleling.....	52
Load shedding.....	53
Unload breakers configuration.....	55
MAINS APPLICATION.....	59
Change over mode.....	59
No break change over.....	65
Permanent.....	70
Multiple mains.....	74
ADVANCED FUNCTIONS.....	76
Easy Flex®.....	76
User variables.....	84
Alternative selection.....	85
Scheduler.....	87
Modbus TCP Mapping.....	90
Logger.....	91
COMMUNICATIONS.....	92
Network.....	92
Modbus TCP/IP.....	94
CRE-Link®.....	97
CANopen.....	98
Modbus client.....	100
CAN bus good practices.....	103

APPENDICES.....	106
Enter a code.....	106
Troubleshooting.....	107
Certifications.....	111
Software variables.....	112

LIST OF FIGURES

Figure 1: Front face of a MASTER COMPACT controller.....	6
Figure 2: Rear face of a MASTER COMPACT controller.....	9
Figure 3: Simplified wiring diagram.....	9
Figure 4: Panel cutout.....	11
Figure 5: Index menu.....	15
Figure 6: Wiring recommendations.....	18
Figure 7: Wiring of the lower terminals.....	20
Figure 8: Diagram high leg delta.....	22
Figure 9: 12VDC power supply wiring.....	23
Figure 10: Chronogram of the digital inputs delays.....	25
Figure 11: Chronogram of the digital/relays outputs pulse length and activation delay.....	26
Figure 12: Analog input configuration.....	27
Figure 13: Analog input curve library.....	28
Figure 14: A-1 : 2 wires analog sensor.....	28
Figure 15: A-2 : 1 wire analog sensor.....	29
Figure 16: Digital input configuration.....	29
Figure 17: B-1 : Digital sensor 2 wires.....	30
Figure 18: B-2 : Digital sensor 1 wire.....	30
Figure 19: Coil control chronogram.....	37
Figure 20: Synchronization chronogram.....	40
Figure 21: Application example using phase offset.....	42
Figure 22: Load/Unload ramp chronogram.....	43
Figure 23: Reattempt to close after an electrical fault.....	47
Figure 24: Sequence of load shedding.....	54
Figure 25: Example of application with unload breakers.....	57
Figure 26: Unload breakers behavior.....	58
Figure 27: Change over mode functions.....	59
Figure 28: Change over mode during a Mains failure.....	60
Figure 29: Change over mode with remote start.....	61
Figure 30: Change over : operating mode diagram.....	63
Figure 31: No break change over with remote start.....	65
Figure 32: No break change over when the remote start is off.....	66
Figure 33: No break change over : operating mode diagram.....	68
Figure 34: Permanent mode.....	70
Figure 35: Permanent : operating mode diagram.....	72
Figure 36: Multiple mains.....	74
Figure 37: Easy Flex® list of variables.....	76
Figure 38: Using read only and read/write variables.....	76
Figure 39: Adding a variable block to the Easy Flex® variables area.....	77
Figure 40: Drag and drop of a variable in an instruction.....	77

Figure 41: Easy Flex® list of operators.....	77
Figure 42: Drag and drop of an operator in an instruction.....	78
Figure 43: Example of equation.....	78
Figure 44: Setting the NOT function of a variable block.....	79
Figure 45: Setting the Timer ON/Timer OFF function of a variable block.....	79
Figure 46: Setting the assignment type of an instruction.....	79
Figure 47: Example of assignment.....	80
Figure 48: Adding an instruction to a condition.....	80
Figure 49: Adding an instruction to a function.....	81
Figure 50: Editing a function.....	81
Figure 51: Deleting an instruction through drag and drop.....	82
Figure 52: Easy Flex® debug mode.....	82
Figure 53: Page of the function Alternative selection.....	85
Figure 54: Adding variables button.....	85
Figure 55: Equation block definition.....	85
Figure 56: Scheduler icons definition.....	87
Figure 57: Scheduler with an event without periodicity.....	87
Figure 58: Form of the scheduler.....	88
Figure 59: Scheduler supervision.....	88
Figure 60: Modbus connection settings menu.....	100
Figure 61: Modbus server settings menu.....	101
Figure 62: Modbus reception menu.....	101
Figure 63: Modbus transmission menu.....	101
Figure 64: CAN bus accepted wiring topologies.....	103
Figure 65: CAN bus wiring example.....	103
Figure 66: Wrong placement of the termination resistor on the CAN bus.....	104
Figure 67: Declaration of conformity.....	111

DESCRIPTION

FRONT FACE



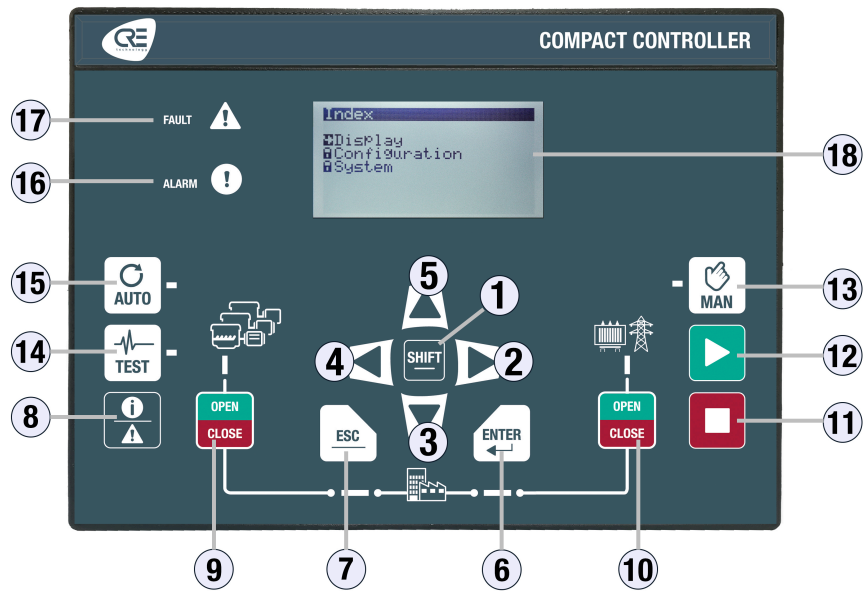





Figure 1. Front face of a MASTER COMPACT controller



OPERATOR MANUAL

PIN	Buttons	Functions
1	SHIFT button	Additional functions.
2	Right arrow button	Navigation button (Right).
3	Down arrow button	Navigation button (Down).
4	Left arrow button	Navigation button (Left).
5	Up arrow button	Navigation button (Up).
6	ENTER button	Validating entry / MENU .
7	ESC button	Cancel entry / escape MENU .
8	Information button	Allows access to the active faults, active alarms, events history or information pages.
9	Bus circuit breaker button	Can only be used in MAN mode. Bus circuit breaker control. Press to open. Press to close (synchronization & load transfer will be done automatically if Bus is powered & configuration is setup for paralleling operation).
10	Mains circuit breaker button	Can only be used in MAN mode. Mains circuit breaker control. Press to Open. Press to close (synchronization & load transfer will be done automatically if Bus is powered & configuration is setup for paralleling operation).
11	Stop button	Can only be used in MAN mode. Press to stop the Power plant. Pressing once this button will set the Generator off load and initiate cooling down sequence
12	Start button	Can only be used in MAN mode. Press to start the Power plant.
13	MAN button	MAN mode. The associated LED lights up when the mode is activated.
14	TEST button	TEST mode. The associated LED lights up when the mode is activated.
15	AUTO button	AUTO mode. The associated LED lights up when the mode is activated.
16	Alarm indicator	The LED flashes when an alarm appears. The LED is lit when an alarm is acknowledged, but not reseted.
17	Fault indicator	The LED flashes when a fault occurs. The LED is lit when a fault is acknowledged, but not reseted.
18	LCD screen	Screen size: 40mm x 70mm; Back-light : typical 50cd/m ² , configurable. Type: STN; 256 x 128 pixels.

Navigation keys

Buttons	Navigation mode	Edition mode
	Scrolling menus/parameters	Modifying parameters values once selected: When up/down arrow buttons are used to modify values, holding the button will accelerate the entry scrolling.
	<p>Right arrow:</p> <ul style="list-style-type: none"> • Accessing a menu. • Navigating right in display/parameters pages <p>Left arrow:</p> <ul style="list-style-type: none"> • Return to previous menu. • Navigating left in display/parameters pages. 	NA
	<p> +  will increase/decrease the brightness of the LCD display.</p> <p> +  will increase/decrease the contrast of the LCD display.</p>	NA
	Returns to previous menu.	Cancels the settings and returns to Navigation mode.
	Accessing a menu / Switching to Edition mode.	Validation of the modified parameter and return to Navigation mode.

Button inhibition

To inhibit front panel buttons, use the **Controller settings** ⇒ **System** ⇒ **Buttons inhibition (i4Gen)** page. This page shows the list of front panel buttons, tick the corresponding box to inhibit actions on the button.

It is also possible to inhibit the buttons by Modbus by modifying the variable [8102]. Each bit of the variable corresponds to a button. To know the bit associated to each button, please refer to the chapter [Software variables \(on page 112\)](#). Ex : Bit number 6 will inhibit the "Enter" button, bit number 1 will inhibit the "Shift" button.

External requests for button activation

It is possible to remotely activate button actions by Modbus TCP, for a remote manual control for example. If a button action is controlled by Modbus TCP, the last request received (external or from the front panel) is treated in priority and cancel the previous request.

MAN / AUTO: If the 2 modes are requested, the **MAN** mode request cancels the **AUTO** mode one. The buttons on the front panel can be replaced by external commands via digital inputs.

REAR FACE

Figure 2. Rear face of a MASTER COMPACT controller

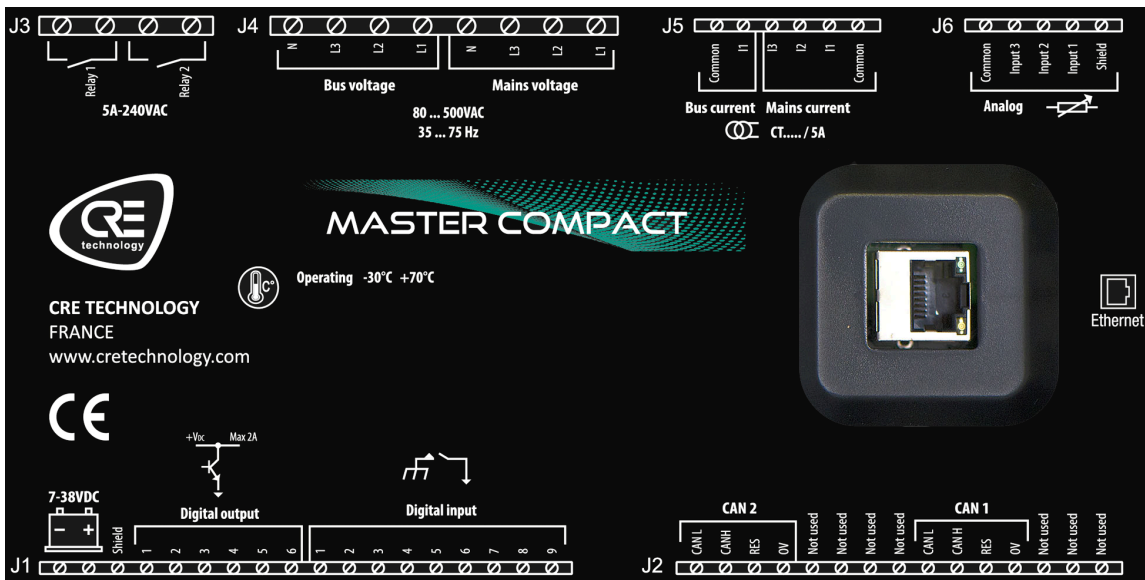
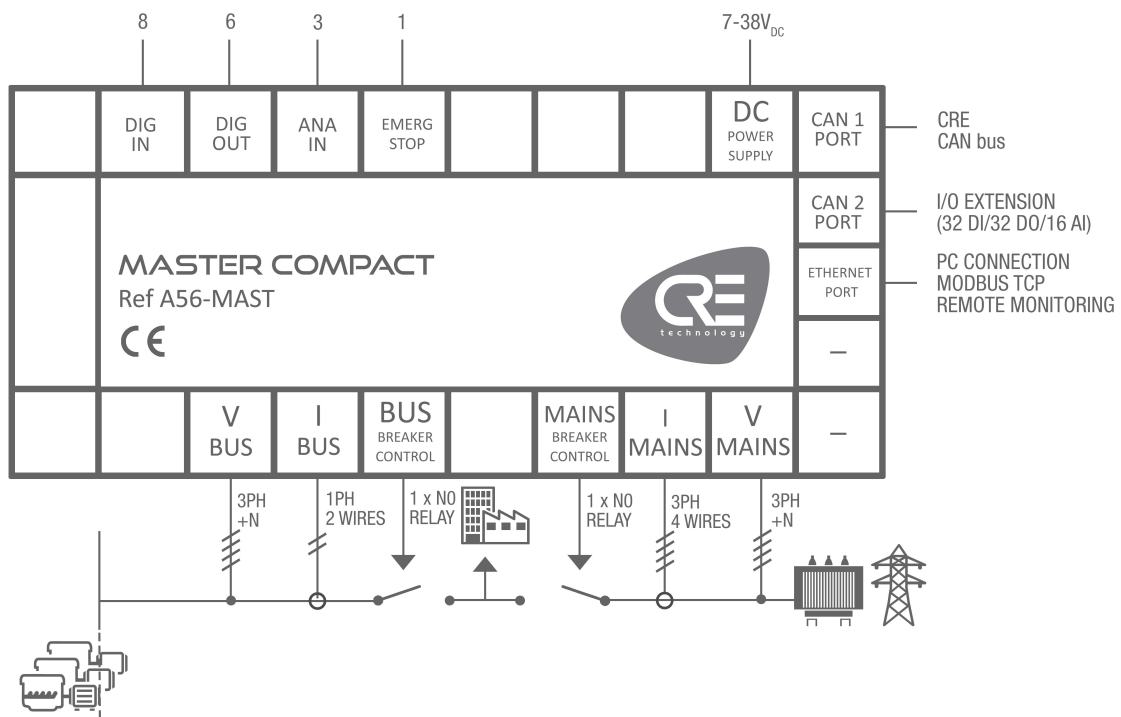

Figure 3. Simplified wiring diagram



PANEL MOUNTING

This unit is designed to be panel mounted, which provides user with access only to the front panel.

WARNING



THIS UNIT IS NOT GROUNDED

Failure to follow these instructions may damage the unit.

- Take all measures against Electronic Static Discharges.
- Do not try to open the unit.

Environmental requirements

- Operating temperature: -20...70°C (-4...158°F); LCD display slows down a bit under -5°C (23°F). Avoid direct exposure to the sun.
- Storage temperature: -40...70°C (-40...158°F).
- Altitude: ≤ 4000m (13123ft) for a max AC voltage of 480VAC; ≤ 5000m (16404ft) for a max AC voltage of 400VAC.

Unpacking

Make sure the packaging contains:

- The unit
- 6 connectors.
- 1 fixing kit composed of 2 parts.
- 4 screws.
- A delivery bill.

Unpack and keep the packaging in case of return.

Make sure the unit does not show scratches or visible defaults. Otherwise describe them on the RMA sheet (available on [CRE TECHNOLOGY website](#)) and return it with the product to your distributor.

Installation

Preparation

- Torque of mounting brackets: 0.4Nm.
- Cut the panel with a dimension of 220x160mm (8.7x6.3in) minimum.
- Make sure the cut-out is smooth and clean.

Figure 4. Panel cutout

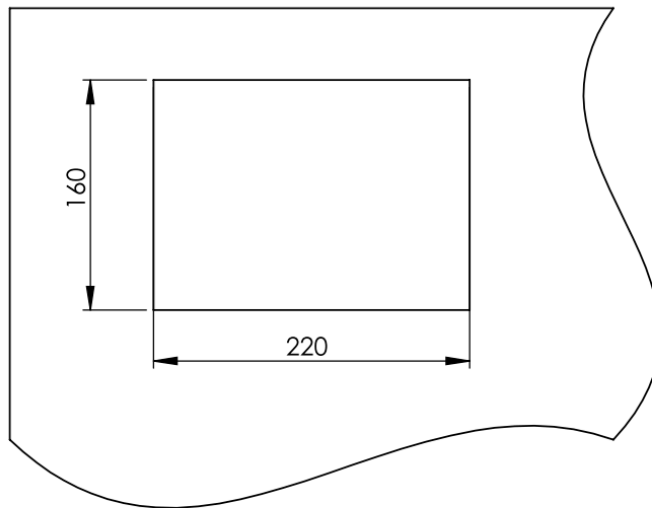

Mounting

0	Tool : cross-head screwdriver size 1.	
1	Pass the unit through the mounting surface.	
2	In the rear, cover each of the four spacers using the 2 parts of the fixing kit.	
3	Screw a first corner against the mounting surface.	
4	Repeat on the diagonally opposite spacer.	
5	Repeat on the other diagonal and tighten equally (do not overtighten).	

UL REQUIREMENTS



Note: Skip this chapter if your application does not require to follow the UL specification.

Circuit separation

The wires connected to the terminal blocks for communication, for sensors and for the battery should be separated and secured to maintain at least 1/4" (6mm) separation between the wires connected to the Mains those connected to the Bus unless all conductors are rated 600V or greater.

Other circuits specifications

For information on circuits ratings, see chapter [Wiring \(on page 17\)](#).

Mains specifications

Over-voltage Category

III, 300VAC system voltage.

Mains / Bus Voltage Measurements (J4)

300VAC max P-N, 2 phases; 500VAC P-P 3 phases, 35...75Hz.

Current Inputs (J5)

Must be connected through listed or recognized isolating current transformers with secondary rating of 5A max 50/60Hz. (XODW2.8) Instrument transformers (according to IEEE C57.13 standard or the equivalent).

Communication Circuits

Must be connected to UL listed equipments.

Output Pilot Duty (J3)

250VAC, 5A max general purpose, 240VAC, 1/4HP for NO contact, 1/6HP for NC contact, Output pilot duty: C150, C300.

Digital outputs (J1)

FET: Fuel shutoff: 63VA, 1.8A max current.

Overcurrent protection (DC supply and L1, L2, L3, N)

Installer shall protect DC supply and L1, L2, L3, N by fuse Type: R/C (JDYX2/7), or R/C (JDYX2) and CSA Certified Class 1422-30.

Rating of fuses:

- DC supply to be protected by 5A, 40VDC max.
- L1, L2, L3, N, fuse protection 100mA/600VAC max.

Wiring of the terminals

Terminal (screw type):

- Tightening Torque: 3.5lb.in (0.4Nm)

Wires:

- 28-14 AWG, Cu, 75°C min.

Conductor protection must be provided in accordance with NFPA 70, Article 240.

Low voltage circuits (35VDC or less) must be supplied from the engine starting battery or an isolated secondary circuit.

Environment

Device must be installed in an unventilated or filtered ventilation enclosure to maintain a pollution degree 2 environment.

Maximum surrounding air temperature rating: 45°C.

Advanced wiring diagram

Wiring diagrams are available on the website [CRE TECHNOLOGY](#).

Installation

For information on installing the product, see chapter [Panel mounting \(on page 10\)](#).

USAGE

PASSWORD

The menus will be automatically locked if no operation is performed during the time set in the *Controller settings* ⇒ *System* ⇒ *Password* page (Factory setting: 30 minutes).
The standby screen will be displayed.





The module provides secured password access to protect configuration changes and limit data accessibility:

Level	Default password	Authorization	Accessible pages and items
0	No password. Press 	By default, this level is not password protected, but one can be set.	Pages of the Controller supervision menu only.
1	1	User level, settings and commissioning.	Pages of the Controller supervision and Controller settings menus.
2	1234	Used to change advanced settings.	Advanced settings.

Passwords can be changed using *i4Gen Suite* software.

To access the **Controller supervision** menu, press .

To access the **Controller settings** menu, the padlock must be unlocked:

1. Press  to select **Controller settings**.
2. Press  to switch to password input mode (as for other settings).
3. Change the character by pressing .
4. Move to the next character by pressing .
5. Repeat the operation for each character.
6. Confirm the password by pressing .

LCD

Navigation

Press , then, select the required menu, then press  and enter the level 1 password if necessary (Settings):

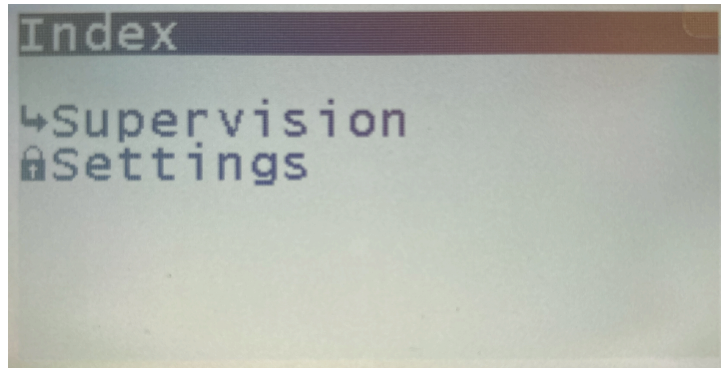

Figure 5. Index menu





A black pointer spots the currently selected item/setting.

Two main menus are available on the LCD screen and three in the **i4Gen Suite** software:





- The menu **Controller supervision** gives all product measurements in real time.
- The menu **Controller settings** is used to adjust the controller and system settings (date/time, screen features, ...).
- The menu **i4Gen** (only available in the configuration software) is used to adjust the software settings.

To cycle through the menus and menu items, press  or .

To cycle through the pages of the actual menu, press  or .

Edition





To change a setting:

1. Navigate to the setting to be changed.
2. Press  to switch to **Edition** mode; the current value blinks.
3. Press  or  to get the new value.
4. Press  to validate the new value,  to reject it. Module returns to **Navigation** mode.

It is also possible to modify the parameters using the Modbus TCP protocol.



Dedicated pages

Dedicated pages includes:

- Active fault: currently active or unacknowledged faults. To reset faults, press  + .
- Active alarm: currently active or unacknowledged alarms. To reset alarms, press  + .

- History: a list of all alarms/faults/events that happened with their state and timestamp.
- Information pages.

Press  to access the dedicated pages menu. It is then possible to navigate through these dedicated pages using the arrow buttons.

To return to the previous page, press  or .

History

Up to 500 archived events can be displayed on the screen.

Each event is time-stamped as follows:

jj/mm/yy hh:mn:ss protection name On (or Off).

Information

These pages show the current status of the controller state with the time elapsed in each state.

Controller state [4000] displays the current status of the unit regarding the management of the system's automatism.

Information variables: to display any variable, enter the code of the variable to be displayed.

WIRING

Tool: insulated screwdriver Ø1.5 mm (0.04 in), tightening torque: 0.8 Nm (7 lb-in) max.

Accessories: 4, 5, 6, 8, 15 & 18-terminal cable connectors, protective gloves, carpet if the floor is wet.

⚠ WARNING

THE UNIT IS NOT PROTECTED

Failure to follow these instructions may damage the unit.

Use external fuses:



- Mains and Bus phases: 100mA/600VAC
- Battery positive: 5A/40VDC

Install the fuses as near as possible to the unit, in a place easily accessible to the user.

⚠ DANGER

RISK OF ELECTRIC SHOCK, EXPLOSION OR ARCING

Failure to follow these recommendations may result in death or serious injury.



- The module may only be installed and maintained by qualified electricians.
- Use personal protective equipment (PPE).
- Follow good safety practices for electrical work.
- Turn off the power before installing or replacing a fuse, and before installing the module.
- Use equipment adapted to check the absence of voltage.
- Do not use a resettable fuse.

General procedure

1. Make sure the cable connectors are not plugged in.
2. Take on protective gloves.
3. Connect the wires on each cable connector in accordance with the National Wiring Regulations.
4. Plug each cable connector onto the related connector.
5. Plug a direct Ethernet cord (RJ45, male-male, 100m max., 100Ω; a crossover cable such as 3-m long A53W1 is OK as long as your switch uses auto MDI/MDIX technology or if the link to PC is direct) and lock the rear door.

Recommendations

Wires section: 1.5mm²(AWG15).

To avoid ElectroMagnetic Interferences, shield cables appropriately; for CAN bus, see [CAN bus good practices \(on page 103\)](#).

Isolation : keep the power cable separate from the CAN bus cables. The latter can be installed in the same duct as the low level I/O wires (under 10V DC).

If power and communication cables have to cross each other, do it at right angles to avoid crosstalk:

Figure 6. Wiring recommendations

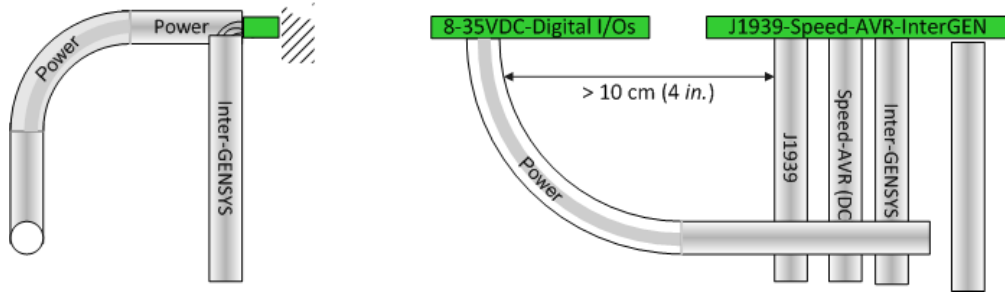

Wiring diagrams are available on the website [CRE TECHNOLOGY](http://www.cretechnology.com).

Upper terminals

⚠ DANGER



EXPOSED TERMINALS

Failure to follow this instruction may result in death, serious injury or equipment damage. Do not touch L1, L2, L3 terminals nor use non-insulated tools near them. These terminals are unprotected and will expose the user to dangerous voltages.

Terminal blocks	Label	Description	Note
Relay outputs (J3)			Normally open. Breaking capacity: 5A, 240VAC.
Relay 1		Relay 1 +	
		Relay 1 –	
Relay 2		Relay 2 +	
		Relay 2 –	
AC voltage (J4)			100...480VAC, 35...75Hz, 100mA max; accuracy: 1% fsd.
Bus voltage	N	Neutral of the Bus	Optional.
	L3	Voltage of the phase 3 of the Bus	These lines must be protected externally with 100mA/600VAC fuses.
	L2	Voltage of the phase 2 of the Bus	
	L1	Voltage of the phase 1 of the Bus	
Mains voltage	N	Neutral of the Mains	Optional.
	L3	Voltage of the phase 3 of the Mains	These lines must be protected externally with 100mA/600VAC fuses.
	L2	Voltage of the phase 2 of the Mains	
	L1	Voltage of the phase 1 of the Mains	
Current inputs (J5)			Short-circuit protection available.

Terminal blocks	Label	Description	Note
Bus current	Common	Common point of the electrical currents.	<p>Connect the common point of the electrical currents to this terminal.</p> <p>! Important: This terminal must also be connected to the ground. Failure to follow this instruction may damage the controller.</p>
	I1	Current of the phase 1 of the Bus	<p>0...5A. Maximum rating: 15A during 10s.</p> <ul style="list-style-type: none"> • Load: 1VA. Keep the lead length short to preserve accuracy (up to 0.5% full scale deviation). • Maximum value of the external CT ratio and other details can be found in i4Gen Suite.
Mains current	I3	Current of the phase 3 of the Mains	<p>0...5A. Maximum rating: 15A during 10s.</p> <ul style="list-style-type: none"> • Load: 1VA. Keep the lead length short to preserve accuracy (up to 0.5% full scale deviation). • Maximum value of the external CT ratio and other details can be found in i4Gen Suite.
	I2	Current of the phase 2 of the Mains	
	I1	Current of the phase 1 of the Mains	
	Common	Common point of the electrical currents.	<p>Connect the common point of the electrical currents to this terminal.</p> <p>! Important: This terminal must also be connected to the ground. Failure to follow this instruction may damage the controller.</p>
Analog inputs (J6)			0...500Ω.
Analog	Common	Common of the analog inputs	Connect it to the battery minus terminal.
	Input 3	Analog input 3	
	Input 2	Analog input 2	
	Input 1	Analog input 1	
	Shield	Ground	Connect to the ground.

Lower terminals

⚠ WARNING



RISK OF EQUIPMENT DAMAGE

Failure to follow this instruction can damage the controller.

Connect battery negative to the module terminal 8...35VDC– with 1.5mm² (AWG15) cable.

OPERATOR MANUAL

Figure 7. Wiring of the lower terminals

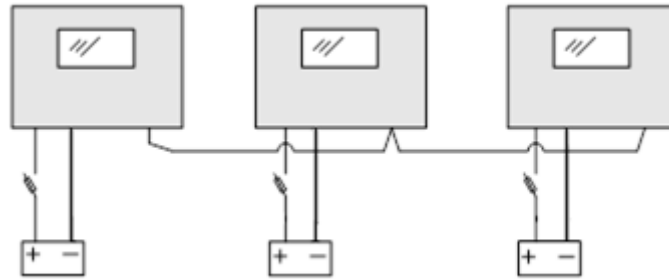

Terminal block	Label	Description	Notes
Power supply and digital inputs/outputs (J1)			
Power supply (7-38VDC)	-	Power supply -	1.5mm ² (AWG15).
	+	Power supply +	7...38VDC, consumed current: 130mA at 24V (standby and operation).
	Shield	Ground	Connect to the ground.
Digital outputs	1	Digital output 1	Free digital output (max: 1.8A). Protected against short circuits. A reactive load is supported. Not isolated from power supply.
	2	Digital output 2	
	3	Digital output 3	
	4	Digital output 4	
	5	Digital output 5	
	6	Digital output 6	
Digital inputs	1	Digital input 1	Free digital input with 10kΩ pull-up. Accepts NO or NC contact to 0V. Not isolated from power supply.
	2	Digital input 2	
	3	Digital input 3	
	4	Digital input 4	
	5	Digital input 5	
	6	Digital input 6	
	7	Digital input 7	
	8	Digital input 8	
	9	Digital input 9	
CAN 2, CAN 1, speed output, AVR output, magnetic pick-up (J2)			
CAN 2 (for J1939 and CANopen)	CAN L	CAN low	Blue wire.
	CAN H	CAN high	White wire.
	RES	Resistor -	Connect to the "CAN H" terminal when the inner resistor must be inserted (bus ends).

Terminal block	Label	Description	Notes
	0V	Shield	<p>Use twisted pair cables.</p> <p>There are two possible wiring for this terminal.</p> <p>First wiring (recommended in most cases): do not connect this terminal.</p> <p>Second wiring:</p> <ul style="list-style-type: none"> • Connect the shield to the 0V terminal on all controllers. CAN1 and CAN2 has galvanic separation, so no ground loops are created. • Do not connect the 0V terminal to the ground.
CAN 1 (for CRE-Link®)	CAN L	CAN low	White wire with blue strip (when using a CRE TECHNOLOGY cable).
	CAN H	CAN high	Blue wire with white strip (when using a CRE TECHNOLOGY cable).
	RES	Resistor - terminal	Connect to the "CAN H" terminal when the inner resistor must be inserted (bus ends).
	0V	Shield	<p>Use twisted pair cables.</p> <p>There are two possible wiring for this terminal.</p> <p>First wiring (recommended in most cases): do not connect this terminal.</p> <p>Second wiring:</p> <ul style="list-style-type: none"> • Connect the shield to the 0V terminal on all controllers. CAN1 and CAN2 has galvanic separation, so no ground loops are created. • Do not connect the 0V terminal to the ground.

⚠ WARNING



RISK OF EQUIPMENT DAMAGE

Failure to follow this instruction can damage the CAN transmitter/receiver.

Switch off the unit before plugging or unplugging the CAN bus connector or disconnecting wires.



Note: In case of a power outage, the unit remains functional for 70ms at 24V, and 20ms at 12V.

Potential transformers ratio definition

The potential transformer can be connected in various ways. According to the type of potential transformer connection, the potential transformer ratio to set in the controller may be different:

- If the primary winding is connected in star(wye) and the secondary winding is connected in delta, the ratio is: $PTratio = \frac{U_{nom}}{100\sqrt{3}}$
- If the primary and secondary windings are both connected in star(wye), the ratio is: $PTratio = \frac{U_{nom}}{100}$

Other systems of voltage

For a **bi-phase 180°** application, connect voltages and currents to L1-L3 terminals (and N). The same logic applies for I1-I3 (and common).

For a **mono-phase** application, connect voltages and currents to L1-N terminals. The same logic applies for I1 and common.

There are 3 triphase high leg delta systems:

Figure 8. Diagram high leg delta

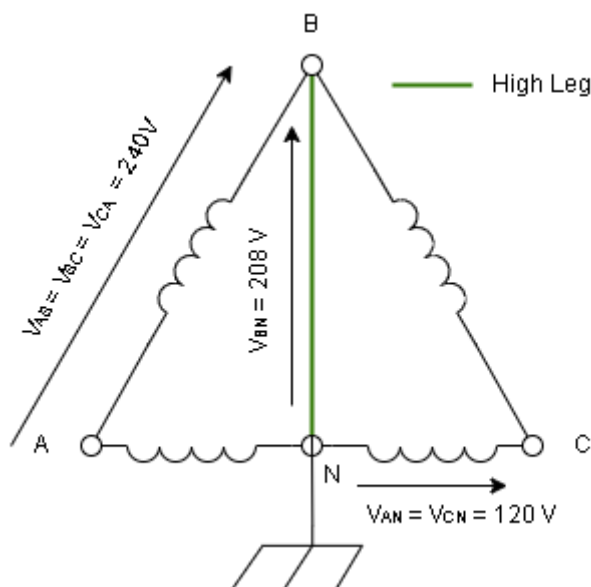

A wiring to neutral is required to use these systems.

If **Triphase L1-N-L2** is selected, connect the "High leg" voltage (B-N) on L3, both other phases on L1 and L2.
 If **Triphase L2-N-L3** is selected, connect the "High leg" voltage (B-N) on L1, both other phases on L2 and L3.
 If **Triphase L3-N-L1** is selected, connect the "High leg" voltage (B-N) on L2, both other phases on L3 and L1.

⚠ WARNING



OVER VOLTAGE RISK WITH HIGH LEG DELTA VOLTAGE SYSTEMS

Failure to follow these instructions may damage the unit.

The maximal P-N voltage of the product is 270 VAC (which is equal to 310 VAC for P-P voltage). If higher voltages are required, potential transformers should be used. See [Potential transformers ratio definition \(on page 21\)](#).

Powering the module with a 12VDC battery

A voltage drop from 12V to 6V can occur when the power consumption of the starter is too high and the battery undersized. This drop can reset the module. To counter this problem, a capacitor and a diode need to be wired as indicated in the schematic below:

The diode needs to be able to handle high currents (ex: Littelfuse DST2045AX). Typically select a 24000µF capacitor that handles at least 25V or higher (ex : KEMET ALS71A243DB040).

Figure 9. 12VDC power supply wiring

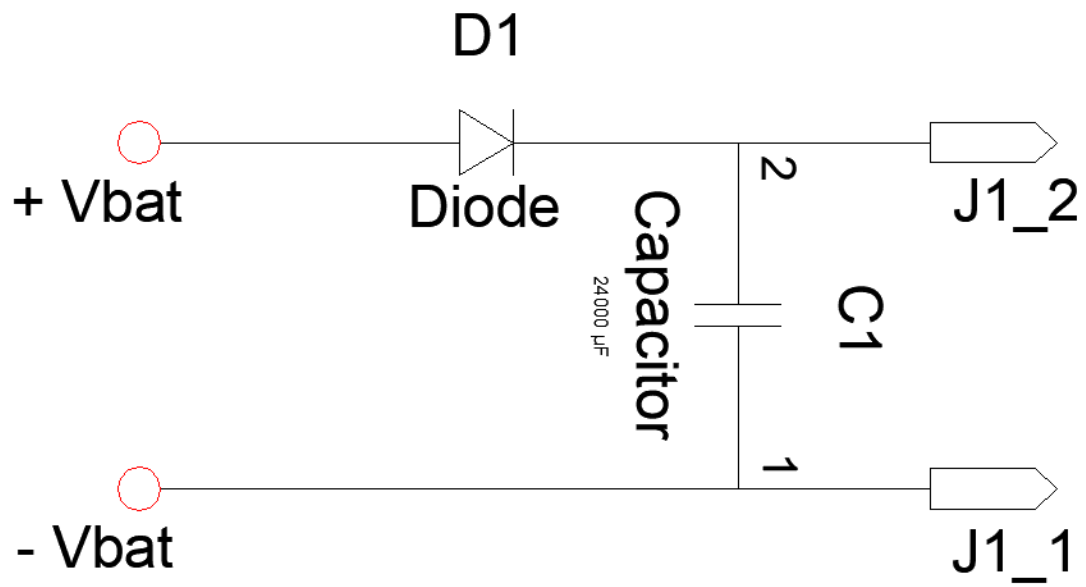

DIGITAL INPUTS

Several parameters can be configured for each digital input:

- **Label** (only in *i4Gen Suite* software)
- **Function**
- **Direction**
- **Validity**
- **Timer ON**
- **Timer OFF**

Label

This is the name you give to the input. If programmed accordingly, the label will be shown in the following pages: digital inputs, information, alarm, and fault.

Validity

Validity indicates when the digital input is taken into account. This parameter can take four values:

Value	Validity	Description
0	Never	Never active: must be selected if you do not use the input.
1	Always	Always active: the input is monitored as long as the module is powered.
2	After valid protect	The input is monitored at the end of the <i>Delay before activation of the protections</i> [2004] delay. ⁽¹⁾
3	When gen ready	The input is monitored when the Power plant is ready for use.

⁽¹⁾Configure the protection inhibition time in **Controller settings** ⇒ **General** ⇒ **Timers**.

Direction

For each input, two options are available:

Value	Label	Function
0	Normally opened	To be used for standard cases unless the input is used as protection.
1	Normally closed	Must be selected if the input is normally connected to 0V (open when active).

Delays

For each input, two delays can be defined in 100ms steps between 0 and 6553s:

Figure 10. Chronogram of the digital inputs delays

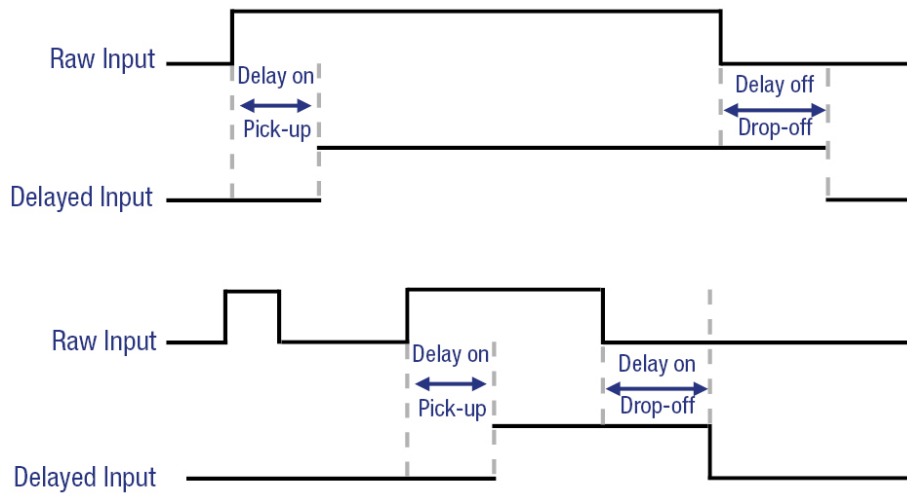

Functions

Each input can be configured. To access all functions, use **i4Gen Suite**.
 Function list is available in the chapter [Software variables \(on page 112\)](#).

DIGITAL/RELAYS OUTPUTS

Several parameters can be configured for each digital/relay output:

- **Label** (only in *i4Gen Suite* software)
- **Function**
- **Polarity** (sometimes referred to as **Direction**)
- **Pulse length: 0 means no pulse**
- **Timer ON**

Polarity

Each output can be:

- **Normally energized**: the output is de-energized when its function is activated.
- **Normally de-energized**: the output is energized when its function is activated.

Pulse length and activation delay

Each digital/relays output can be configured to act as a pulse. The pulses lengths are defined with the parameters [2761] to [2766] for digital outputs and [2767] to [2768] for relays output. As soon as a pulse begins, it will last for the configured duration even if the associated function is not active anymore.

Set to 0 in order to have a continuous output (no pulse).

It is also possible to delay the output activation using parameters [2793] to [2798] for digital outputs and [8250] to [8251] for relays output.

Setting the activation delay to 0 means there will be no delay.

Figure 11. Chronogram of the digital/relays outputs pulse length and activation delay

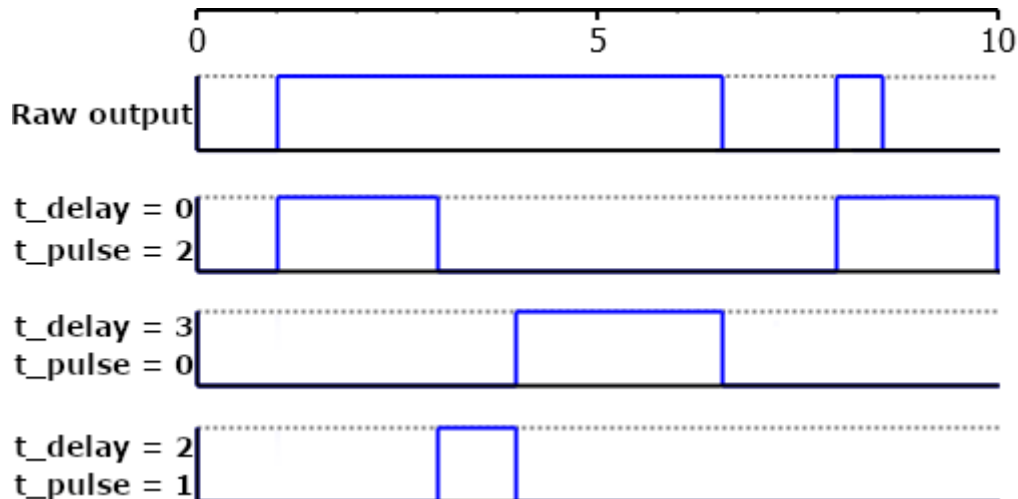

Functions

Each output can be configured. To access all functions, use *i4Gen Suite*. Function list is available in the chapter [Software variables \(on page 112\)](#).

ANALOG INPUTS

General analog input configuration

1. **Label:** Analog input's label (limited to 14 characters).
2. **Type:** Defines the way you want to use your analog input : unused, analog input, digital input.

The analog input configuration page changes according to the selected type.

Type set to unused

No configuration available.

Type set to analog input

Figure 12. Analog input configuration

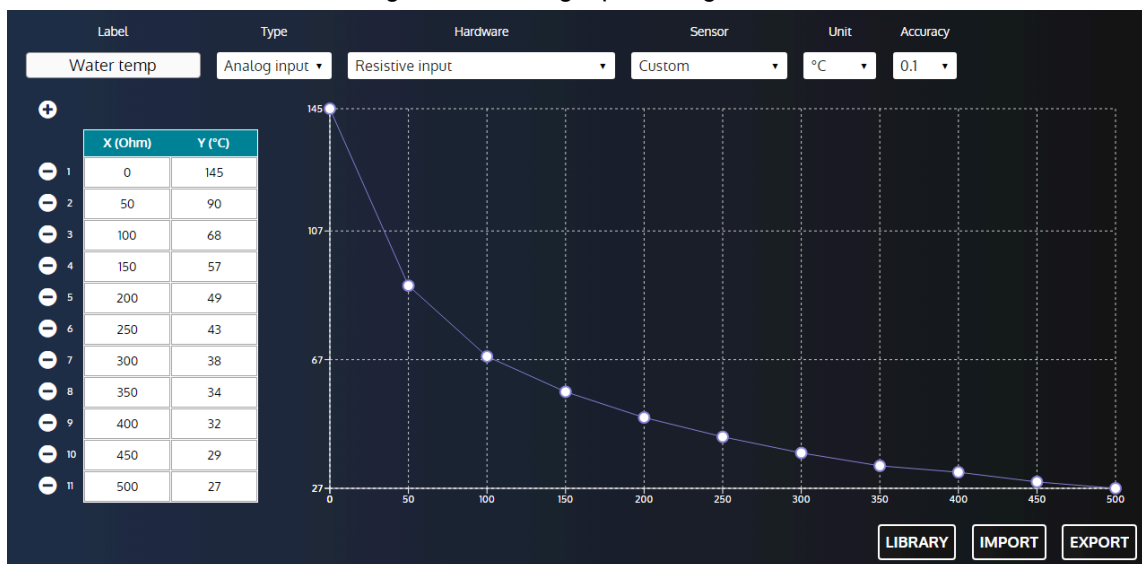

1. **Hardware:** Defines the hardware type of the analog input (resistive / 20mA transducer).
2. **Unit:** Defines the unit of the analog input.
3. **Accuracy:** Defines the accuracy of the analog input (i.e. number of decimal digits to display the measured value).
4. **Calibration points table** (up to 31 points):

Calibration is used to estimate a reading from a resistance/current value by interpolation between 2 resistance/current values. Negative values are supported.

To set calibration points:

- Press the + button to add a new point.
- Press the - button to remove an existing point.
- To set the X-axis coordinate of a point, fill the corresponding X input.
- To set the Y-axis coordinate of a point, fill the corresponding Y input.

5. **Curve display:** Display of the calibration points on a curve in X-axis ascending order.
6. **Library:** Opens the curve library.

Figure 13. Analog input curve library

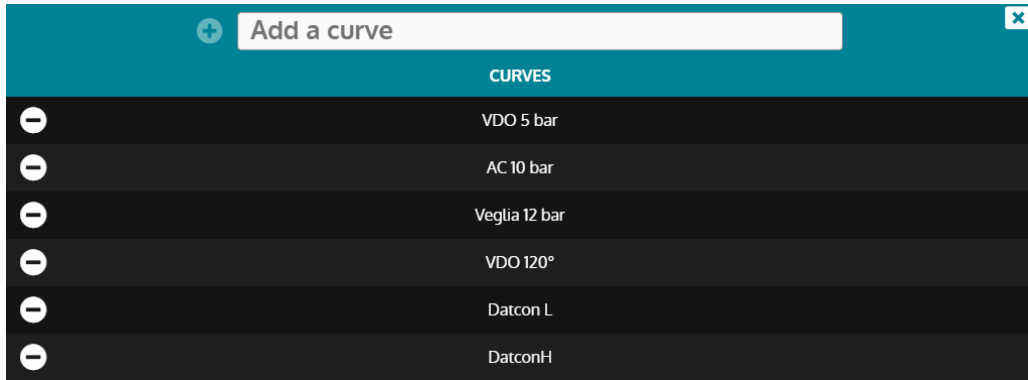

Enter a name in the input and press the + button to save the current curve into the library. Press the - button to remove a saved curve (not available for factory curves). Click on a curve to load it into the analog input configuration.

- 7. **Import:** Opens the file browser to import a curve file into the analog input configuration.
- 8. **Export:** Opens the file browser to export a curve file.

How to connect analog sensors

You can use 1 or 2-wire analog sensors, or 1-wire or 2-wire logical sensors.



Note: Our recommendations: In each case you must always connect the analog inputs' "common" terminal (J6) to the power supply minus terminal (J1) and also connect it to the engine block in the case of 1-wire sensor. You must use the following wiring (Incorrect wiring of the analog inputs can cause damage to the module, or cause a wrong measurement).

Figure 14. A-1 : 2 wires analog sensor

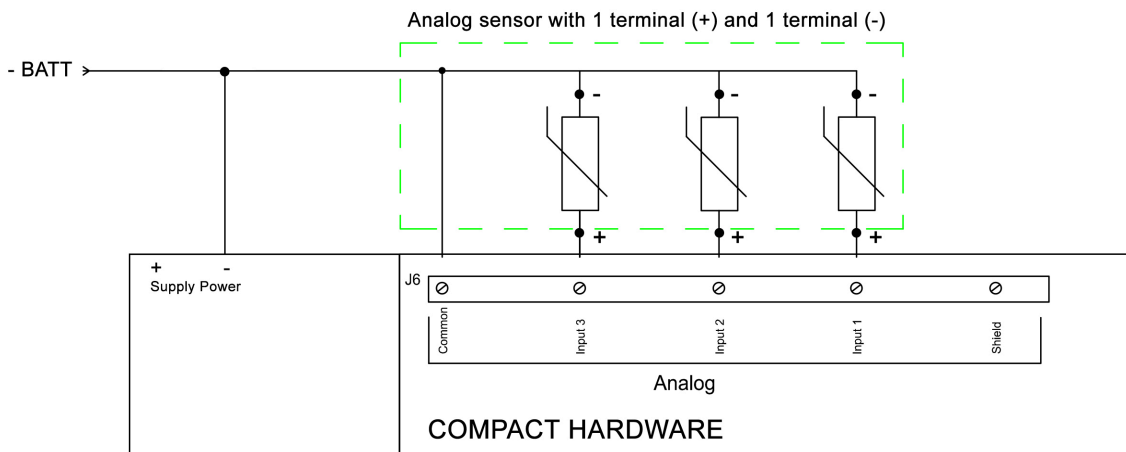
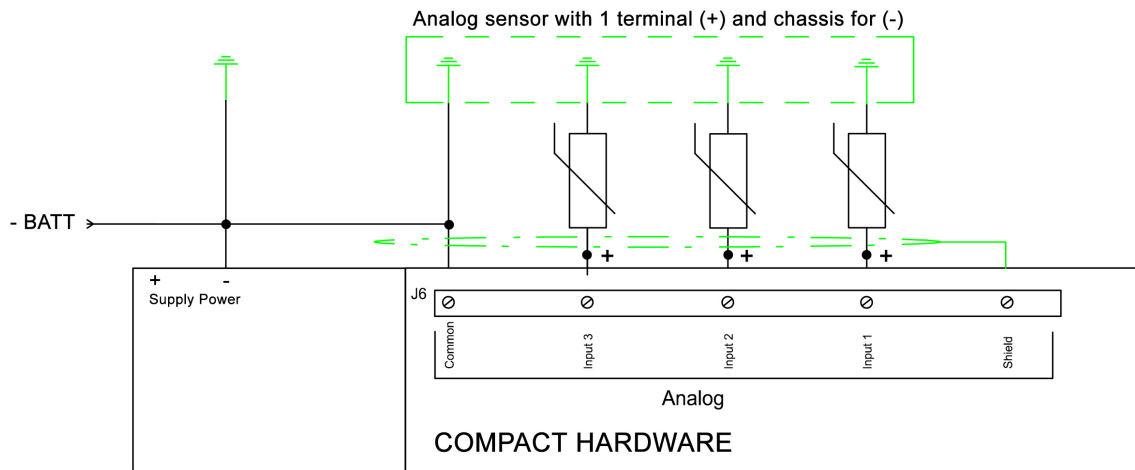

Figure 15. A-2 : 1 wire analog sensor



⚠ WARNING



THE WARRANTY WILL BE VOIDED IF THE MANUFACTURER'S INSTRUCTIONS ARE NOT RESPECTED.

To act as a 0...20mA input or 4...20mA, connect the input with a 39Ω resistor between the analog input and the analog common.

The calibration of the 20mA transducer can then be performed as on a resistive analog input depending on the characteristics of the sensor.

Type set to digital input

Figure 16. Digital input configuration

Label	Type	Function	Validity	Polarity	Delay
Remote start	Digital input ▾	Remote start on load	Always ▾	Normally opened ▾	0,0

1. **Function:** Defines the digital input function.
2. **Validity:** Condition to take the digital input into account.
 - Never: The input will never be taken into account.
 - Always: The input will always be taken into account.
 - When gen ready: The input will be taken into account when the Power plant is ready.
 - After valid protect: The input will be taken into account when the variable *Protection validation* [4681] is equal to 1. (check the chapter [Digital inputs \(on page 24\)](#) for more information)
3. **Polarity:** Digital input's polarity.
4. **Delay:** Delay until the input becomes active.

How to connect digital sensors

When an analog input is used as a logic input, applying a 0V to the input enables it, applying nothing disables it.

Figure 17. B-1 : Digital sensor 2 wires

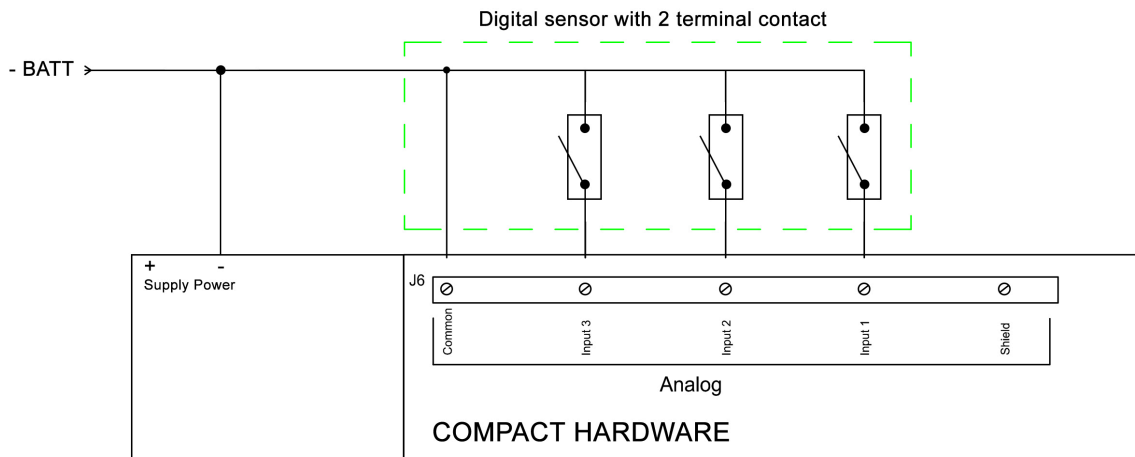
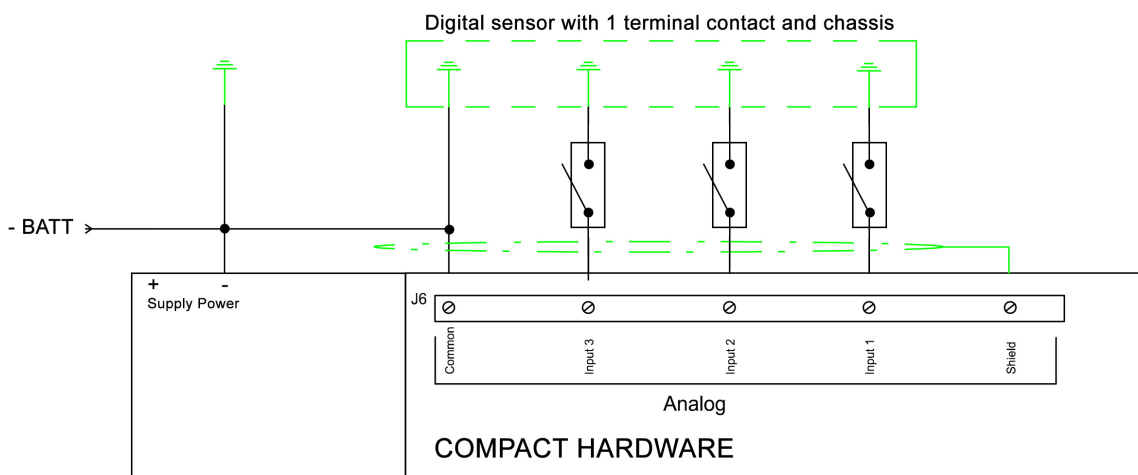

Figure 18. B-2 : Digital sensor 1 wire



⚠ WARNING



THE WARRANTY WILL BE VOIDED IF THE MANUFACTURER'S INSTRUCTIONS ARE NOT RESPECTED.

Protections

Several parameters can be configured from the **Controller settings** ⇒ **Protections** ⇒ **Other protections** ⇒ **Analog inputs** page:

- Level (LV): Limit value before triggering the protection. It can be a low or high threshold.
- Delay (TM): Time after which the protection is triggered.
- Control (CT): Control of the protection. It defines the action related to the protection
- Direction (SS): Polarity of the protection. It defines if the limit value is a low or high threshold

These parameters are available in the **Controller settings** ⇒ **Protections** ⇒ **Other protections** ⇒ **Analog inputs** page.

OPERATOR MANUAL

	Protections				
	Threshold	Timer	Control	Direction	Function
Analog input 1 level 1	[2600]	[2601]	[2602]	[2606]	[2678]
Analog input 1 level 2	[2603]	[2604]	[2605]		
Analog input 2 level 1	[2608]	[2609]	[2610]	[2614]	[2679]
Analog input 2 level 2	[2611]	[2612]	[2613]		
Analog input 3 level 1	[2616]	[2617]	[2618]	[2622]	[2680]
Analog input 3 level 2	[2619]	[2620]	[2621]		

HYSTERESIS (DIGITAL INPUT)

For a given hysteresis, three different digital signals are required:

- Two digital inputs are used respectively as low threshold and high threshold signals.
- One digital output is used to control an equipment with a hysteresis

The hysteresis settings can be found in the **Controller settings** ⇒ **Inputs/Outputs** ⇒ **Digital inputs** ⇒ **Hysteresis on digital input** page. Each hysteresis proposes the following parameters (the first hysteresis is taken as example):

- **Hysteresis 1 enable for digital input**
- **Pulse length DO 1**
- **Direction hysteresis 1**

Hysteresis 1 enable for digital input

Enables/disables the hysteresis.

Pulse length DO 1

The delay to wait when the condition is met (reaching the low/high threshold) before activating the hysteresis output.

Direction hysteresis 1

For each hysteresis, two options are available:

Value	Label	Function
0	Set on low threshold, reset on high	<p>The associated digital output will be set when the digital input assigned to the low threshold is activated and it will reset once the digital input assigned to the high threshold is activated.</p> <p>Please note that once the digital output is activated, the state of the digital input assigned to the low threshold will not matter. The digital output state can only change when the digital input assigned to the high threshold is activated.</p>
1	Set on high threshold, reset on low	<p>The associated digital output will be set when the digital input assigned to the high threshold is activated and it will reset once the digital input assigned to the low threshold is activated.</p> <p>Please note that once the digital output is activated, the state of the digital input assigned to the high threshold will not matter. The digital output state can only change when the digital input assigned to the low threshold is activated.</p>

Setting inputs for your hysteresis

To select the required digital input signals, please refer to [Digital inputs \(on page 24\)](#). The digital input functions to be used can be found in the **Hysteresis** section of the search engine.

Setting an output for your hysteresis

To select the digital output controlled by the hysteresis, please refer to [Digital/Relays outputs \(on page 26\)](#). The digital output function to be used can be found in the **Hysteresis** section of the search engine.

HYSTERESIS

For a given Hysteresis, two different signals are required:

- One variable for the measure
- One digital output for the hysteresis to activate

Open the **Controller settings** ⇒ **Programming** ⇒ **Hysteresis (i4Gen)** page. Each hysteresis proposes the following parameters (the first hysteresis is taken as example):

- **Enable Hysteresis 1**
- **Hysteresis 1**
- **Low level threshold**
- **Timer on low level threshold**
- **High level threshold**
- **Timer on high level threshold**
- **Hysteresis Direction 1**

Enable Hysteresis 1

Enables/disables the hysteresis.

Hysteresis 1

Chooses one among all of the variables of the product to bind the hysteresis with.

Low level threshold

The hysteresis output will be activated when the variable reaches a value lower than or equal to the configured low level threshold value.

Timer on low level threshold

The delay to wait once the variable value reaches the low level threshold before activating the hysteresis output.

High level threshold

The hysteresis output will be activated when the variable reaches a value greater than or equal to the configured high level threshold value.

Timer on high level threshold

The delay to wait once the variable value reaches the high level threshold before activating the hysteresis output.

Hysteresis Direction 1

For each hysteresis, two options are available:

Value	Label	Function
0	Set on low threshold, reset on high	<p>The associated digital output will be set when the low threshold value is reached and it will reset on reaching the high threshold value.</p> <p>Please note that once the digital output is activated, the low threshold value will not matter. The digital output state can only change on reaching the high threshold value.</p>
1	Set on high threshold, reset on low	<p>The associated digital output will be set when the high threshold value is reached and it will reset on reaching the low threshold value.</p> <p>Please note that once the digital output is activated, the high threshold value will not matter. The digital output state can only change on reaching the low threshold value.</p>

Setting an output for your hysteresis

To set a digital output, please refer to [Digital/Relays outputs \(on page 26\)](#). The functions to use can be found in the **Hysteresis** section of the search engine.

SETTINGS

CIRCUIT BREAKERS

Circuit breakers operating modes

Two digital outputs (relay or transistor) are used to control the circuit breakers - 1 for opening and 1 for closing. These outputs allow different types of circuit-breakers to be controlled.

The Bus circuit breaker settings are accessible from **Controller settings** ⇒ **Inputs/Outputs** ⇒ **Breaker** ⇒ **Bus breaker**.

The Mains circuit breaker settings are accessible from **Controller settings** ⇒ **Inputs/Outputs** ⇒ **Breaker** ⇒ **Mains breaker**.



Important: Failure to comply with the following recommendations may cause malfunctions.



Note: Never switch from one operating mode to another while the power plant is running.

Circuit breaker control mode

Value	Mode	Circuit breakers chronogram
0	1: Continuous contact to open. 2: Pulse to close.	
1	1: Continuous contact to open. 2: Continuous contact to close.	
2	1: Under-voltage (MN) coil opening. 2: Pulse to close.	
3	1: Under-voltage coil opening. 2: Continuous contact to close.	
4	1: Pulse to open. 2: Pulse to close.	
5	1: Pulse to open. 2: Continuous contact to close.	

Pulse configuration

The settings can be accessed from **i4Gen Suite** software.

Pulse

The settings of the Bus breaker pulse can be found in the **Controller settings** ⇒ **Inputs/Outputs** ⇒ **Breaker** ⇒ **Bus breaker** page.

For the pulse control of the Bus breaker, set the parameter [2301].

The settings of the Mains breaker pulse can be found in the **Controller settings** ⇒ **Inputs/Outputs** ⇒ **Breaker** ⇒ **Mains breaker** page.

For the pulse control of the Mains breaker, set the parameter [2314].

Coil Control

The settings of the Bus breaker coil can be found in the **Controller settings** ⇒ **Inputs/Outputs** ⇒ **Breaker** ⇒ **Bus breaker** page.

For the fail-safe control of the Bus breaker, set the parameters [2302] and [2303].

The settings of the Mains breaker coil can be found in the **Controller settings** ⇒ **Inputs/Outputs** ⇒ **Breaker** ⇒ **Mains breaker** page.

For the fail-safe control of the Mains breaker, set the parameters [2315] and [2316].

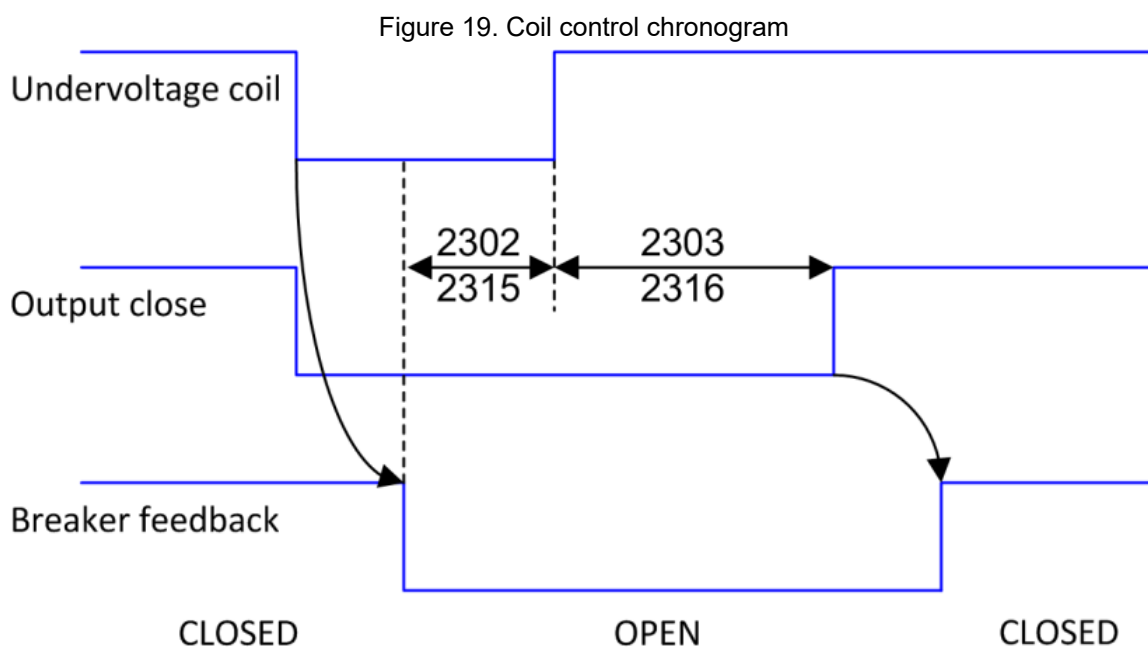

To detect the position of the circuit breaker, a logic input must be configured as:

Function	Value
Power plant circuit breaker position feedback	1 = circuit breaker closed (LED displayed on the front panel).
Mains circuit breaker position feedback	1 = circuit breaker closed (LED displayed on the front panel).



Note: If the circuit breaker position feedback is not assigned to a digital input then the breaker position will always be assumed to match the breaker control output of the module.

Configuration of circuit breaker commands

Two digital outputs (relay or transistor) must be configured as described in the table below and connected to the circuit breaker.

Function	Description
<i>Bus breaker closure</i>	Command to close the breaker. Output signal (pulse or continue) will depend on configuration in Breaker settings. (continuous, pulse, MNcoil).
<i>Bus breaker opening</i>	Command to open the breaker. Output signal (pulse or continue) will depend on configuration in Breaker settings. (continuous, pulse, MNcoil).
<i>Mains breaker close</i>	Command to close the breaker. Output signal (pulse or continue) will depend on configuration in Breaker settings. (continuous, pulse, MNcoil).
<i>Mains breaker open</i>	Command to open the breaker. Output signal (pulse or continue) will depend on configuration in Breaker settings. (continuous, pulse, MNcoil).

Verification

DANGER





RISK OF ELECTRIC SHOCK, EXPLOSION OR ARCING

Failure to follow these recommendations may result in death or serious injury.







- The module may only be installed and maintained by qualified electricians.
- Use personal protective equipment (PPE).
- Follow good safety practices for electrical work.
- Turn off the power before installing or replacing a fuse, and before installing the module.
- Use equipment adapted to check the absence of voltage.
- Do not use a resettable fuse.

Follow these instructions in order to check the Bus breaker:

1. Connect the circuit breaker position feedbacks and check them on the product. The corresponding LED should light up when the circuit breaker is closed.
2. Start the Power plant in **MAN** mode by pressing  and then .
3. Once the Power plant is ready and if there is no voltage on the other side of the breaker, press the button Bus breaker .
4. Check that the Bus circuit breaker is closed and that the Bus circuit breaker LED is lit.
5. If possible apply a load bank (active and reactive) on the Bus and check the powers, currents, voltages and $\cos(\phi)$.
6. To open the Bus breaker, press the button Bus breaker .
7. Check that the Bus circuit breaker is open and that the Bus circuit breaker LED is off.
8. Press  to stop the Power plant.

Follow these instructions in order to check the Mains breaker:

OPERATOR MANUAL

1. Connect the circuit breaker position feedbacks and check them on the product. The corresponding LED should light up when the circuit breaker is closed.
2. Press  to be in **MAN** mode.
3. Check that the Power plant isn't running. If it isn't the case, stop the Power plant by pressing .
4. Press the button Mains breaker  to close the breaker.
5. Check that the Mains circuit breaker is closed and that the Mains circuit breaker LED is lit.
6. If possible, apply a load bank (active and reactive) on the Mains and check the powers, currents, voltages and $\cos(\phi)$.
7. Press the button Mains breaker  to open the breaker.
8. Check that the Mains circuit breaker is open and that the Mains circuit breaker LED is off.

SYNCHRONIZATION

Functioning

The module launches the synchronization only if the Mains provides at least 80% of the nominal voltage. It manages a correction on frequency and voltage to go and stay on the acceptance windows (can be handled in **Controller settings** ⇒ **Electrical** ⇒ **Synchronisation check**). When the Mains voltage and the Bus voltage are synchronized, the module allows to close the circuit breaker.

In case of synchronization fails, the action can be set with the variable [2804] in **Controller settings** ⇒ **Electrical** ⇒ **Synchronisation check**.

Condition

- *Voltage acceptance* [2800].
- *Frequency acceptance* [2801].
- *Phase Angle acceptance* [2802].
- *C2S dwell time* (Synchronization dwell time before authorizing to close the breaker) [2809].

Visualization

Label	Description	Variables
<i>Phase sequence match</i>	Identical phase order on both sides of the circuit breaker (OK = 1 or NOK = 0)	[306]
<i>Voltage match</i>	Identical voltage amplitudes on both sides of the circuit breaker (OK = 1 or NOK = 0)	[307]
<i>Frequency match</i>	Identical frequencies on both sides of the circuit breaker (OK = 1 or NOK = 0)	[308]
<i>Phase match</i>	The phase difference between the voltages on either side of the circuit breaker is zero (OK = 1 or NOK = 0)	[309]
<i>Synch check relay OK</i>	Active if the sources are synchronized on both sides of circuit breaker (OK = 1 or Not OK = 0). Do not confuse with the closing order.	[310]

Chronogram

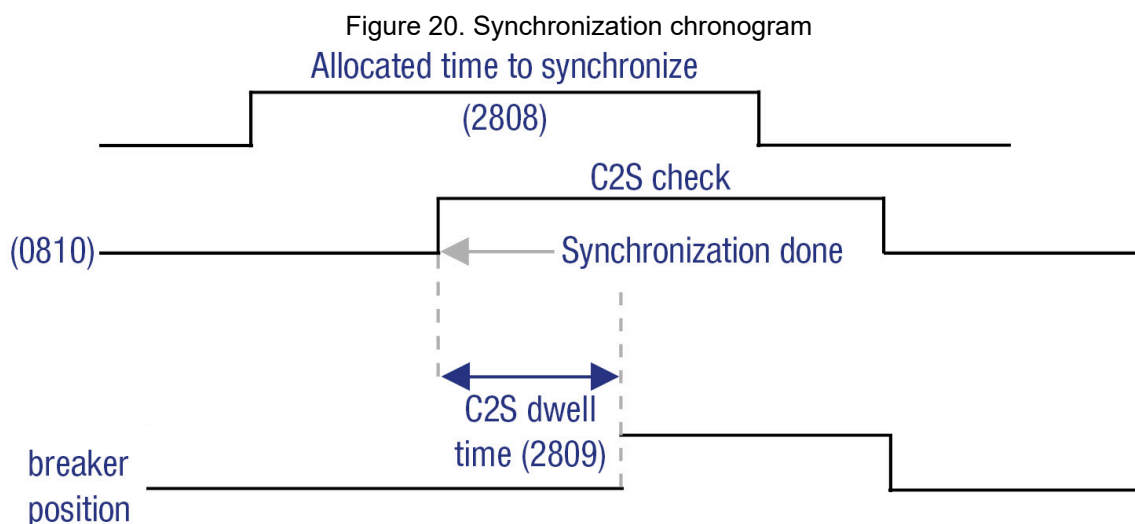

Adjustments

Prerequisite: In order for the module to correctly control the Power plant (which is controlled with **GENSYS COMPACT PRIME** units), the parameter [2017] must be properly set in each **GENSYS COMPACT PRIME** unit. Each **GENSYS COMPACT PRIME** unit must be in **AUTO** mode without a remote start input activated (The generator is started by the MASTER via CAN bus).

DANGER





RISK OF ELECTRIC SHOCK, EXPLOSION OR ARCING

Failure to follow these recommendations may result in death or serious injury.











- The module may only be installed and maintained by qualified electricians.
- Use personal protective equipment (PPE).
- Follow good safety practices for electrical work.
- Turn off the power before installing or replacing a fuse, and before installing the module.
- Use equipment adapted to check the absence of voltage.
- Do not use a resettable fuse.

Adjustment procedure

1. Disconnect the Bus circuit breaker control output on the module.
2. Make sure that there is some voltage on the Mains side. The Mains LED should be lit.
3. Press  to be in **MAN** mode. Press the button Mains breaker  in order to close the Mains breaker. The Mains breaker LED is lit.
4. Start the Power plant by pressing  and check the **Controller supervision** ⇒ **Synchronization (i4Gen)** page.
5. Press the button Bus breaker  in order to start the synchronization.
6. If the Power plant does not synchronize, change the PID of phase of the **MASTER COMPACT** product (assuming that the PID of the **GENSYS COMPACT PRIME** product are correctly set).

Verification

1. Disconnect the Bus circuit breaker control output on the module.
2. Make sure that there is voltage on the Mains side. The Mains LED should be lit.
3. Press  to be in **MAN** mode. Press the button Mains breaker  in order to close the Mains breaker. The Mains breaker LED is lit.
4. Start the Power plant by pressing the button  and check the **Controller supervision** ⇒ **Synchronization (i4Gen)** page.
5. Once the Power plant is ready, press the button Bus breaker .
6. Press  to go to the Information page and check if the module is in synchronizing mode.
7. Go to the menu **Controller supervision** ⇒ **Synchronization (i4Gen)** and check the phase difference. When the phase difference is 0° follow the instructions below:

- a. Check the phase sequence and the concordance of the phases upstream and downstream of the circuit breaker.
 - b. Check the wiring of the Bus and Mains voltage references.
 - c. Check the potential difference between Ph1 Bus and Ph1 Mains. The potential difference must be below 10% of the nominal voltage. Check the potential difference between Ph2 Bus and Ph2 Mains as well.
8. Stop the Power plant by pressing  .
 9. Reconnect the Bus circuit breaker control.
 10. Start the Power plant by pressing  .
 11. Once the Power plant is ready, press the button Bus breaker  . The Power plant should synchronize and then, the product will close the Bus breaker.

Phase offset

This advanced function, only available when the option is enabled, allows a phase offset between the Mains and the Bus during the synchronization phase. In this setup, the module will command the breaker to close with the selected phase angle shift. The phase offset modification can be done in **Controller settings** ⇒ **Electrical** ⇒ **Synchronisation check**. An example of an application can be seen in the schematic below.

Figure 21. Application example using phase offset

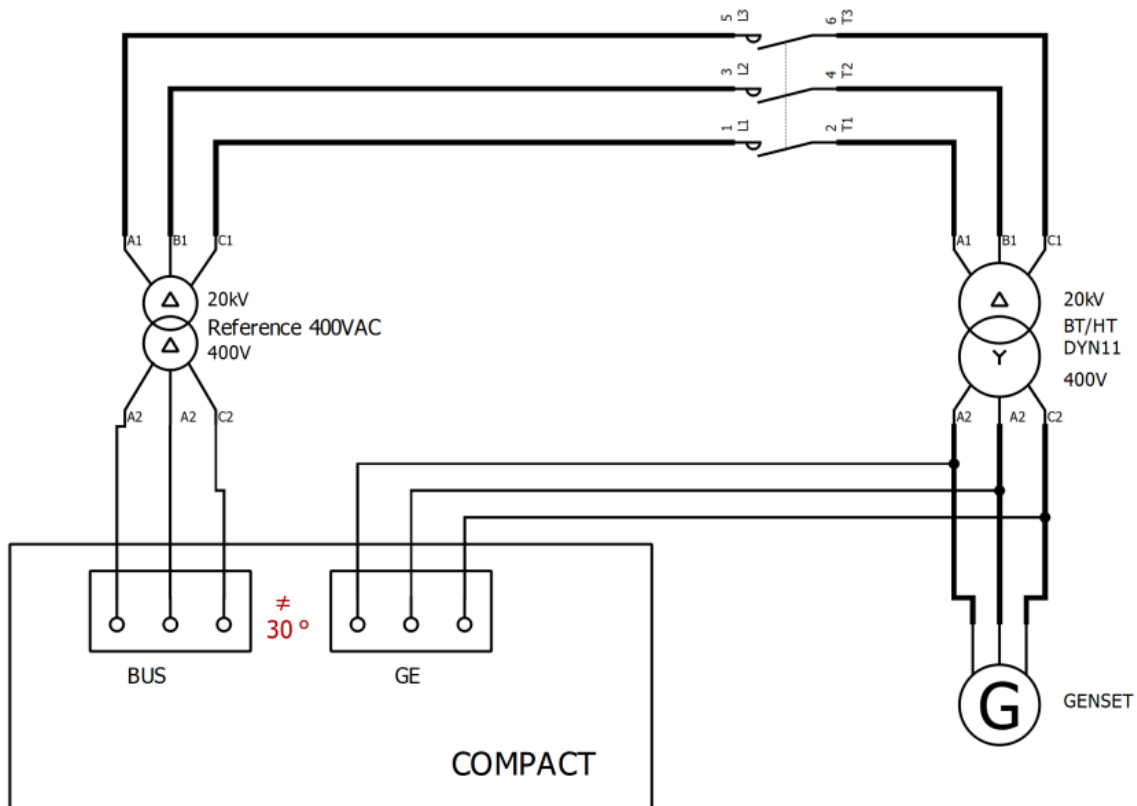

WARNING



MODIFYING THE SETTING IN AN APPLICATION WHERE PHASE SHIFTING IS NOT REQUIRED WILL DAMAGE YOUR ENGINE. BE CAUTIOUS WHEN MODIFYING THIS SETTING.

LOAD/UNLOAD RAMP

Functioning

After a synchronization, the module ramps up the Power plant load to avoid overload or a load impact.

The module calculates the active power setpoint according to the configuration (base load, peak shaving and No break change over). It then starts a load ramp to progressively reach this value.

During the ramp, the module keeps a constant power factor, set by the power factor setpoint [2253] parameter, in order to start a reactive power ramp.

If the production request is stopped, the module starts an unload ramp to progressively reach the Power plant low limit.

The parameters to be set are the following: *Low kW active power threshold* [2866], *High kW active power threshold* [2867], *Load ramp timer* [2853], *Unload ramp timer* [2856]. The timers [2853] and [2856] correspond to the time required to reach the nominal load.

Example: Power rating of the Power plant = 500KW, Load Ramp time = 50 seconds, Unload Ramp time = 22 seconds:

Figure 22. Load/Unload ramp chronogram

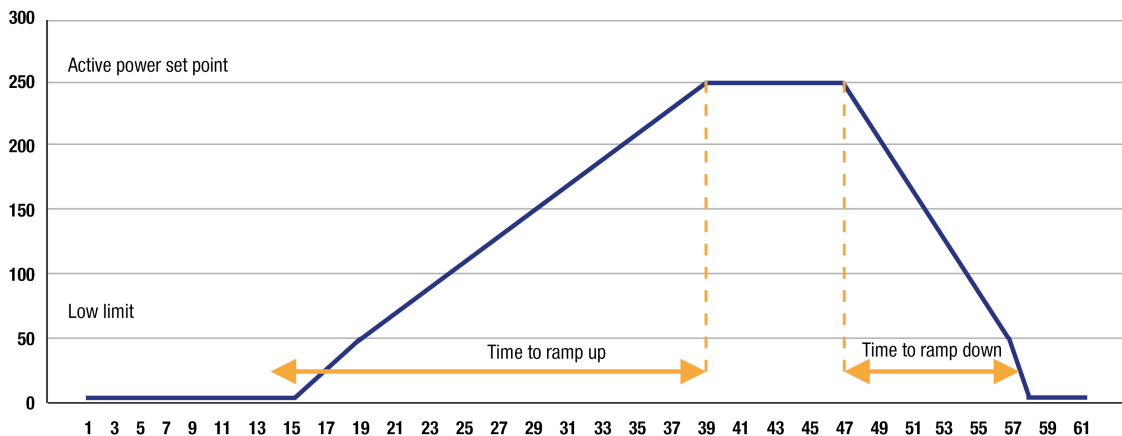

Before stopping the Power plant, the module reduces its load to the low limit and then opens the circuit breaker. If the breaker opening fails at the end of the ramp, the Power plant continues to share the load and shows a breaker opening fault on display.

Verification

For this test, an available load is important.

1. Check that the power measured per phase is positive and balanced.
 - Go to the menu **Controller supervision**. Otherwise check the currents connections.
2. Check that the current power follows the setpoint of KW and KVAR during ramps.

KW/KVAR REGULATION

Functioning

The module switches to active and reactive power regulation mode around its setpoint after a load ramp.

The KW setpoint is calculated differently depending on the following modes:

- Base load mode: Power plant KW setpoint.
- Peak shaving mode: Mains KW setpoint.
- No break change over: alternatively: Power plant KW set-point and Mains KW setpoint.

The module regulates the reactive power according to the power factor setpoint [2253]. The parameter *High kW active power threshold* [2867], configurable in **Controller settings** ⇒ **Electrical** ⇒ **Bus** ⇒ **General**, forbids the Power plant to take more active power than the **active power high threshold**. The remaining active power goes directly to the Mains.

PROTECTIONS

Functionning

The protections are triggered by an internal or external event (internal protection, digital inputs, CAN bus loss, etc.). In order to protect the system, an action can be associated with the triggering of a protection. These actions are of different kinds :

- These actions can just trigger an alarm. An orange LED will flash on the product and the title of the triggered protection will appear in the alarms/faults page.
- These actions can protect the different equipments by carrying out actions that depend on the type of action configured. In this case, the LED will blink orange as long as no human intervention is required, the LED will blink red if a human intervention is required. If the LED flashes orange, the title of the protection that has been triggered can be consulted in the alarms page. If the LED flashes red, the name of the protection that has been tripped can be viewed in the faults page.
- These actions can launch automated sequences to perform the main functions of the product. In this case, no LEDs are flashing. The title of the protection can be consulted in the events page.

Value	Type	Action	Description
0	–	Unused (no action)	–
1	Alarm/ Fault	Bus electrical fault	<p>The protection opens the Bus circuit breaker and tries to re-synchronize again after the timer [2806].</p> <p>The number of resynch attempts is set by variable [2807], it means that if the fault that has tripped the Bus circuit breaker is happening again after each attempt, the Power plant will be stopped.</p>
2	Event	Mains failure	<p>This event will automatically starts the generator and close it on the load in case of loss of Mains power. The Mains circuit breaker will be opened once the generator is ready so if Mains power comes back before that, the controller will just stops the generator. The Mains circuit breaker behavior on Mains failure can be set using the variable [2312].</p> <p>Once Mains power is back, the Mains failure event will be automatically reset after the timer [2009] has elapsed and the module will allow the power plant to stop after its configured sequence (synchronization and load transfer or change over).</p>
3	Alarm	Alarm	The protection is displayed in the alarm page. No action is performed.
4	Fault	Fault (soft shutdown)	The Bus circuit breaker opens, the generators open their circuit breaker and cool down for the duration of the cool down timer, then they stop.
9	Alarm/ Fault	Mains electrical fault	<p>The protection opens the Mains circuit breaker and tries to re-synchronize again after the timer [2806].</p> <p>The number of resynch attempts is set by variable [2807], it means that if the fault that has tripped the Mains circuit breaker is happening again after each attempt, the protection will keep triggering.</p> <p>Once the number of resynch attempts has been reached, the Mains circuit breaker will remain open.</p> <p>The reset function will automatically reset the number of attempts and will automatically close the Mains circuit breaker.</p>

These actions have to be configured in **i4Gen Suite** software. List of potential alarms/faults can be downloaded using the SAVE button beside "Protections configuration" in the **i4Gen ⇒ File transfer** page. A digital output can be configured to indicate that a protection is active.



Note: The protections are active whatever the operating mode is (**MAN, AUTO, TEST**)

All the protections available for the product are explained in the chapter [Software variables \(on page 112\)](#).

Specific protections are explained below.

Emergency stop

The emergency stop function can be performed in two ways:

- Connect an **Emergency stop** button to an **Emergency stop** logic input. It is a software treated emergency stop.
- Action on an alarm or a fault : select **Fault (soft shutdown)**.

Communication

Alarm/Fault	Description	Setting
CANopen	Communication error on the CANopen protocol.	[3059]

For **CRE-Link®** protocol errors, check [CRE-Link® \(on page 97\)](#).

Breaker

Depending on the status of the module, an alarm or circuit breaker fault may occur. This can be a failure closing circuit breaker, failure opening circuit breaker, unexpected opening of the circuit breaker, unexpected closing of the circuit breaker. Alarm or fault depends of the severity of the event.

Reattempt to close after an electrical fault

In the event of an electrical fault:

1. The module opens the circuit breaker.
2. The module will try X times according to the value configured in the parameter *Synchronization Back attempts number* [2807].
3. The module will wait X seconds between each attempt according to the value configured in the parameter *Synchronization back timer* [2806].

Example:

Example with [2807] = 2:

Figure 23. Reattempt to close after an electrical fault

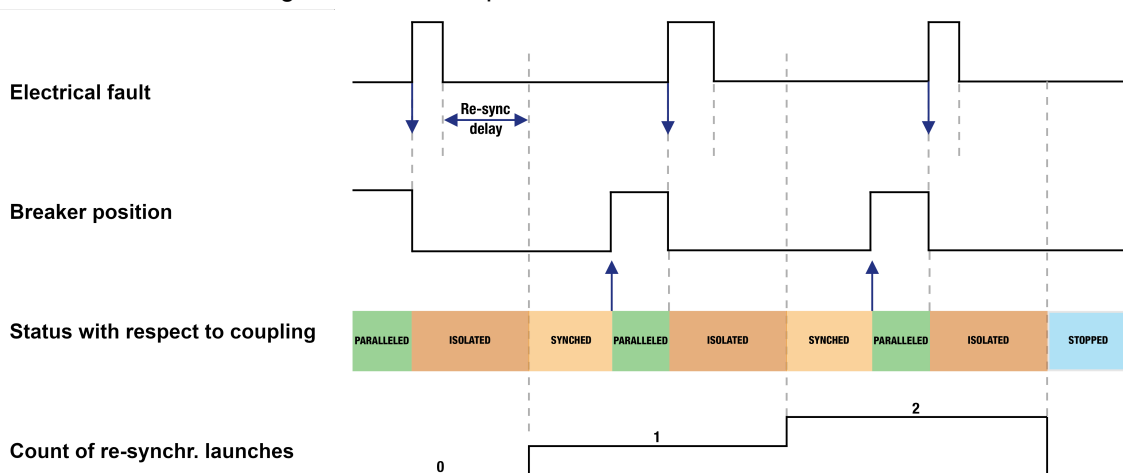

Custom fault and alarm

User variables [8000] to [8099] can be set as alarm or fault using **i4Gen Suite**. The label of the alarms/faults can be customized by changing the label of the related user variable. A user variable set as alarm or fault can be triggered via Modbus or **Easy Flex®**.

Audible or visual warning device

To trigger an external alarm when a protection trips, connect the alarm to a logic output configured as **Horn**. The signal duration is configurable with the parameter *Horn timer* [2478] (0 means that the alarm will be activated until a manual shutdown); alternatively, an input can be configured as **Stop horn** to manually stop the horn.

Reset of alarms and faults

To perform an alarms/faults reset:

- Locally:  + 
- Remote: use the "**Reset faults**" input function.

EVENTS

Functioning

Events are actions performed on the installation that can be monitored by the controller. They are managed in the same way as an alarms and faults, thus they can be seen in the "history" menu where all alarms/faults/events history is listed. Events are also included in the log file together with alarms and faults. Each event can be enabled/disabled in the **Controller settings** ⇒ **General** ⇒ **Events** page.

Variable number	Label	Description
[5000]	<i>Power up</i>	This event is recorded each time the controller is powered on.
[5003]	<i>Mains failure</i>	This event is recorded when the Mains failure protection trigger (see Protections (on page 45) chapter for more information).
[5004]	<i>Mains back</i>	This event is recorded when the Mains failure protection triggered and is no longer active (see Protections (on page 45) chapter for more information).
[5005]	<i>Bus breaker closed</i>	This event is recorded if the controller can read the "closed breaker feedback" from the Bus's breaker (even if the controller didn't close the Bus's breaker by itself). If breaker position feedbacks are not used, the event is triggered on breaker close command instead.
[5006]	<i>Bus breaker opened</i>	This event is recorded if the controller can read the "opened breaker feedback" from the Bus's breaker (even if the controller didn't open the Bus's breaker by himself). If breaker position feedbacks are not used, the event is triggered on breaker open command instead.
[5007]	<i>Mains breaker closed</i>	This event is recorded if the controller can read the "closed breaker feedback" from the mains' breaker (even if the controller didn't close the mains' breaker by itself). If breaker position feedbacks are not used, the event is triggered on breaker close command instead.
[5008]	<i>Mains breaker opened</i>	This event is recorded if the controller can read the "opened breaker feedback" from the mains' breaker (even if the controller didn't open the mains' breaker by itself). If breaker position feedbacks are not used, the event is triggered on breaker open command instead.
[5009]	<i>Manual mode</i>	This event is recorded when the controller is switched to MAN mode (Pressing MAN when the controller is already in MAN mode won't trigger the event).
[5010]	<i>Automatic mode</i>	This event is recorded when the controller is switched to AUTO mode (Pressing AUTO when the controller is already in AUTO mode won't trigger the event).

OPERATOR MANUAL

Variable number	Label	Description
[5011]	<i>Test mode</i>	This event is recorded when the controller is switched to TEST mode (Pressing TEST when the controller is already in TEST mode won't trigger the event).

CONTROL LOOP PID

Empirical adjustment of a PID control loop

1. Set all the gains to 0 (except G gain).
2. Increase the P gain until you have a stable oscillation.
3. Increase the gain D until the oscillation is no longer present.
4. Repeat steps 2 and 3 until the D gain can't cancel the oscillation caused by the P gain.
5. Go back to the previous values of the P and D gains where the D gain cancels the oscillation caused by the P gain.
6. Increase the I gain in order to correct the error between the actual value and the set-point.
Warning: A too high I gain might cause oscillations to the system. The I gain must correct the static error rapidly without oscillations (or small oscillations in order to gain some response time).

ADVANCED SETTINGS

STATIC PARALLELING

Power plant in static paralleling

Except for magnetizing power transformers (see below), there is no specific setting required on a **MASTER COMPACT** controller. Static paralleling settings are done on the controller of each generator.

Magnetizing currents for power transformers

It is possible to set up the controller to close the Bus breaker before initiating the static paralleling sequence in order to magnetize currents for power transformers.

To do so, change the following parameters using the **i4Gen Suite** software:

- Set variable *Power plant minimum number of GE* [2109] available in the **Controller settings** ⇒ **Electrical** ⇒ **Bus** ⇒ **General** menu to **0**.
- Set variable *Mains breaker tripping mode on mains failure* [2312] available in the **Controller settings** ⇒ **Inputs/Outputs** ⇒ **Breaker** ⇒ **Mains breaker** menu to **Immediately** (only available in Advanced mode).

LOAD SHEDDING

Functioning

The load shedding function is the ability to disconnect less important consumers if the Power plant is overloaded even when the full capacity is engaged; this prevents a blackout.

Any module – generally one – in the Power plant can take care of the excessive demand. If the KW demand exceeds the Power plant capacity and/or the frequency has dropped below a threshold for a given time, the dedicated module activates outputs to shed non-essential loads.

You can setup your system to react more or less rapidly depending on the severity of the situation using two levels of thresholds and delays.

Settings

All the settings are explained in the chapter [Software variables \(on page 112\)](#).

They are set in the **Controller settings** ⇒ **Electrical** ⇒ **Power management** ⇒ **Load shedding** page.

Using the **Controller settings** ⇒ **Inputs/Outputs** ⇒ **Digital/relays outputs** page, preset up to 5 outputs to **1st non essential trip...5th non essential trip**.

In the same manner as for protections, you can trigger an action when the shedding capacity runs out (a specific output "Trip alarm" is signaled if [2862] = 3).

Sequence

When one of the two levels is reached and its associated delay has expired, a trip alarm is set and a five-tier shedding starts (level 1) or escalates (level 2): at the end of a cycle based on the parameter [2861] an extra non-essential consumer is phased out till the threshold is reversely passed.

When the active power of the generator exceeds the maximum kW threshold configured or when the frequency drops below the minimum frequency threshold configured:

1. Trip alarm is raised after the related delay, as long as one of the threshold is exceeded.
2. The trip outputs are activated successively after an additional delay; they are locked until a manual reset; they can activate a preset output on a non-essential direct trip.

The charts show the trip alarm and trip outputs depending on the Generator load or frequency:

Figure 24. Sequence of load shedding

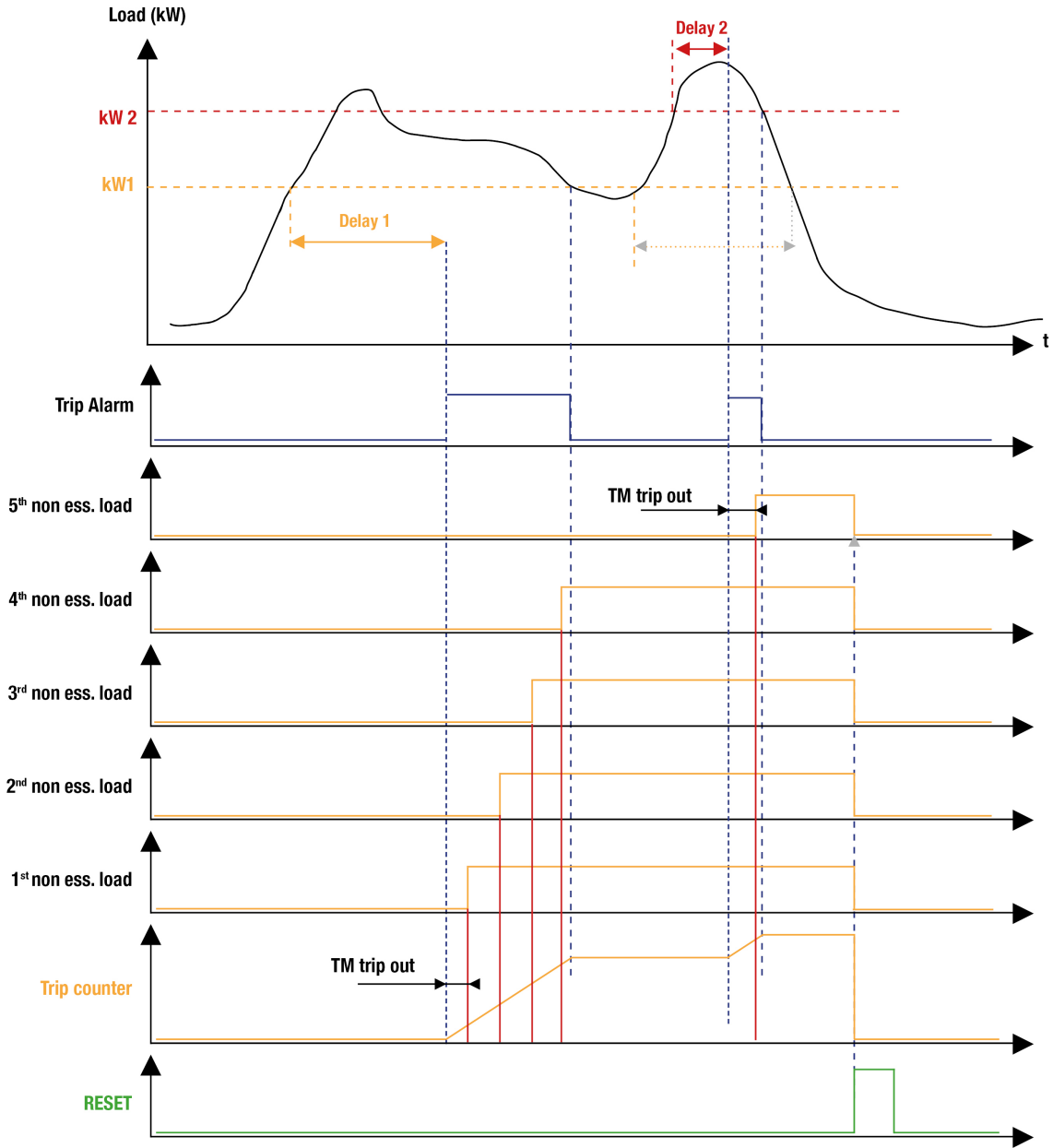

UNLOAD BREAKERS CONFIGURATION

Functioning

Several power management applications require the Power plant to gradually take the load depending on the current nominal power available. The unload breakers configuration allows the user to control, with the module, up to ten additional breakers. These breakers can then be closed according to a "**nominal power available in the Power plant**" threshold and a preset time. The unload breaker priority follows an ascending order (from 1 to 10). All the unload breakers are closed when the Mains is available and the Mains breaker closed. **The Load Dependant Start/Stop** must not be enabled when this functionality is being used.

Settings

Variables	Label	Description
[3730]	<i>Enable unload breakers</i>	Enable unload breakers
[3731]	<i>Unload breaker kW 1</i>	Active power threshold before closing the breaker of the load n°1
[3732]	<i>Unload breaker kW 2</i>	Active power threshold before closing the breaker of the load n°2
[3733]	<i>Unload breaker kW 3</i>	Active power threshold before closing the breaker of the load n°3
[3734]	<i>Unload breaker kW 4</i>	Active power threshold before closing the breaker of the load n°4
[3735]	<i>Unload breaker kW 5</i>	Active power threshold before closing the breaker of the load n°5
[3736]	<i>Unload breaker kW 6</i>	Active power threshold before closing the breaker of the load n°6
[3737]	<i>Unload breaker kW 7</i>	Active power threshold before closing the breaker of the load n°7
[3738]	<i>Unload breaker kW 8</i>	Active power threshold before closing the breaker of the load n°8
[3739]	<i>Unload breaker kW 9</i>	Active power threshold before closing the breaker of the load n°9
[3740]	<i>Unload breaker kW 10</i>	Active power threshold before closing the breaker of the load n°10
[3720]	<i>Unload breaker timer 1</i>	Time before closing the breaker of the load n°1
[3721]	<i>Unload breaker timer 2</i>	Time before closing the breaker of the load n°2
[3722]	<i>Unload breaker timer 3</i>	Time before closing the breaker of the load n°3
[3723]	<i>Unload breaker timer 4</i>	Time before closing the breaker of the load n°4
[3724]	<i>Unload breaker timer 5</i>	Time before closing the breaker of the load n°5
[3725]	<i>Unload breaker timer 6</i>	Time before closing the breaker of the load n°6
[3726]	<i>Unload breaker timer 7</i>	Time before closing the breaker of the load n°7
[3727]	<i>Unload breaker timer 8</i>	Time before closing the breaker of the load n°8
[3728]	<i>Unload breaker timer 9</i>	Time before closing the breaker of the load n°9
[3729]	<i>Unload breaker timer 10</i>	Time before closing the breaker of the load n°10
[4721]	<i>Unload breaker n°1</i>	Use only with 'Unload breakers function'. Output function activated when the conditions to close the breaker of the load n°1 are met
[4722]	<i>Unload breaker n°2</i>	Use only with 'Unload breakers function'. Output function activated when the conditions to close the breaker of the load n°2 are met
[4723]	<i>Unload breaker n°3</i>	Use only with 'Unload breakers function'. Output function activated when the conditions to close the breaker of the load n°3 are met
[4724]	<i>Unload breaker n°4</i>	Use only with 'Unload breakers function'. Output function activated when the conditions to close the breaker of the load n°4 are met

Variables	Label	Description
[4725]	<i>Unload breaker n°5</i>	Use only with 'Unload breakers function'. Output function activated when the conditions to close the breaker of the load n°5 are met
[4726]	<i>Unload breaker n°6</i>	Use only with 'Unload breakers function'. Output function activated when the conditions to close the breaker of the load n°6 are met
[4727]	<i>Unload breaker n°7</i>	Use only with 'Unload breakers function'. Output function activated when the conditions to close the breaker of the load n°7 are met
[4728]	<i>Unload breaker n°8</i>	Use only with 'Unload breakers function'. Output function activated when the conditions to close the breaker of the load n°8 are met
[4729]	<i>Unload breaker n°9</i>	Use only with 'Unload breakers function'. Output function activated when the conditions to close the breaker of the load n°9 are met
[4730]	<i>Unload breaker n°10</i>	Use only with 'Unload breakers function'. Output function activated when the conditions to close the breaker of the load n°10 are met

Configuration with i4Gen Suite software

The settings are available here : **Controller settings** ⇒ **Electrical** ⇒ **Power management** ⇒ **Unload breakers**. The outputs functions must be configured to *Unload breaker n°1* with the number corresponding to the wanted unload breaker. Outputs functions can be configured here : **Controller settings** ⇒ **Inputs/Outputs** ⇒ **Digital/relays outputs**.

Example

Consider the example of an application with 10 generators with a nominal power of 500KW each. The user has configured his unload breakers as followed:

Variables	Value
[3730]	1
[3731]	1000
[3732]	700
[3733]	500
[3734]	200
[3735]	1200
[3736]	50
[3737]	170
[3738]	350
[3739]	20
[3740]	800
[3720]	3
[3721]	3
[3722]	3
[3723]	3
[3724]	3
[3725]	3
[3726]	3
[3727]	3
[3728]	3
[3729]	3

Figure 25. Example of application with unload breakers

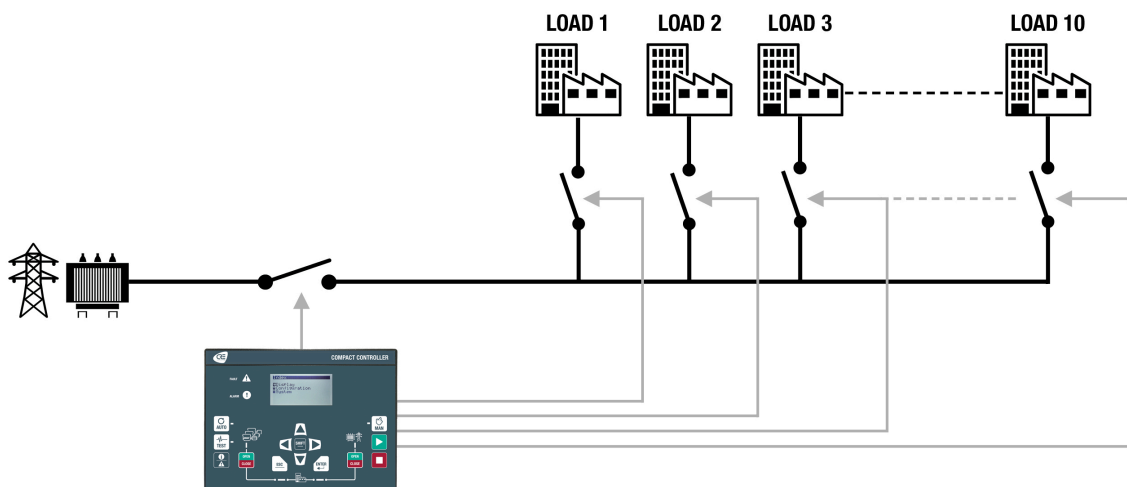

The Power plant will take the load as such: When only one Generator is connected to the Bus, the Power plant has a nominal power of 500KW. Even though the load connected to the third breaker could be handled by the Power plant, the third unload breaker will not close due to the fact that the conditions for the first unload breaker to close are not respected. If a second Generator is connected to the Bus, the Power plant will have a nominal power of 1000 KW. The first unload breaker will close after 3 seconds. The second breaker will only close if the Power plant has at least a nominal power of 1700 KW and so on. The first breaker to open will always be the breaker with the highest number.

The behavior of the first three breakers are shown in the figure below:

Figure 26. Unload breakers behavior

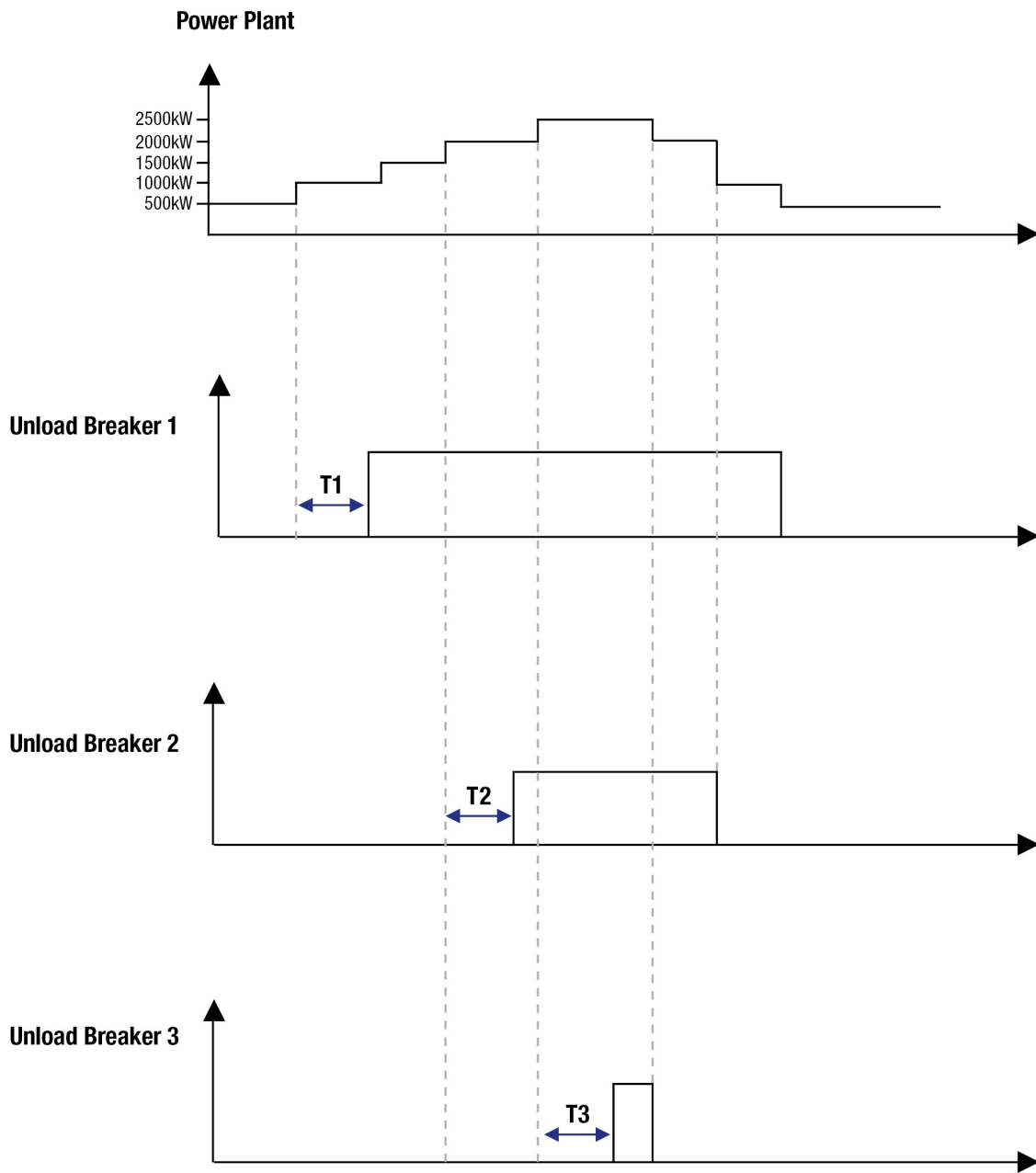

MAINS APPLICATION

In Mains paralleling applications, if a "Mains failure" fault is managed (with protections or logic inputs), the Power plant starts and takes the load when the Mains fail, even if the remote start is deactivated. In all cases, a Mains protection must be set to start the Power plant if the Mains disappears.

CHANGE OVER MODE

Figure 27. Change over mode functions

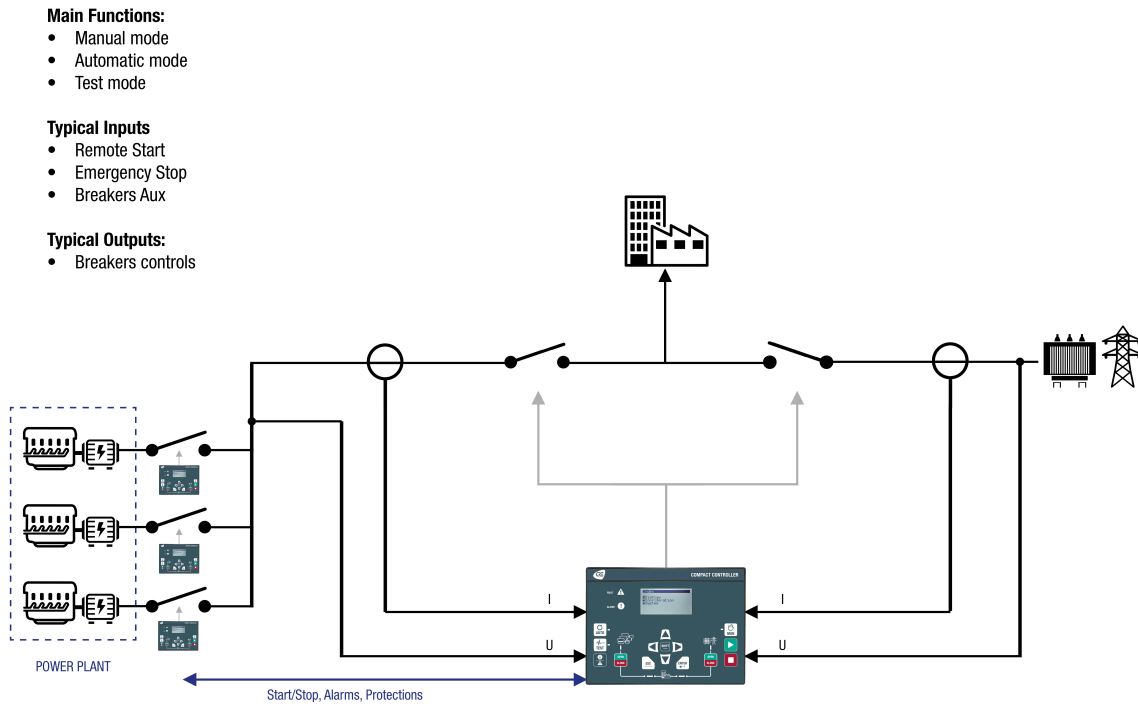

In change over mode the module orders the Power plant to start in the event of a Mains failure. The module opens its Mains breaker and orders the Power plant to close the breakers of the generators. The module then waits until the requirements needed for the Power plant to be ready are met (configurable with the parameters [2108] and [2109]) to close its Bus breaker and take the load. When the Mains returns, the module orders the Power plant to open its Generator circuit-breakers after a preset time. Then, it opens its Bus breaker and closes its Mains Breaker.

Figure 28. Change over mode during a Mains failure

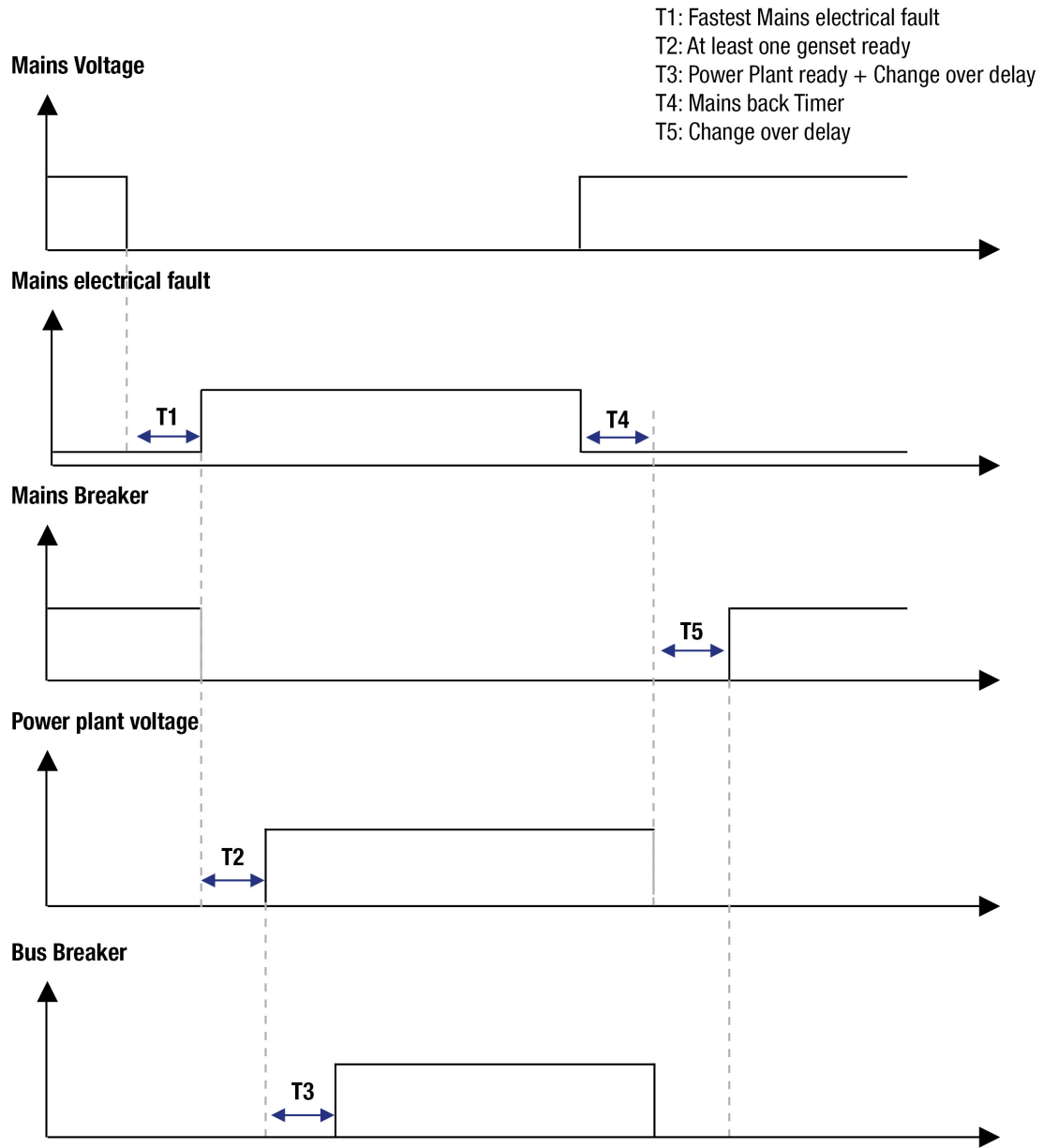

If a remote start is activated when the Mains is present, the module orders the Power plant to start its generators, opens the Mains breaker and orders the Power plant to close its Generator breakers. The **MASTER COMPACT** controller then waits until the requirements needed for the Power plant to be ready are met (configurable with the parameters [2108] and [2109]) to close its Bus breaker after a preset time and takes the load

OPERATOR MANUAL

Figure 29. Change over mode with remote start

- T1: At least one genset ready
- T2: Power Plant ready + Change over delay
- T3: Change over delay
- T4: Change over delay

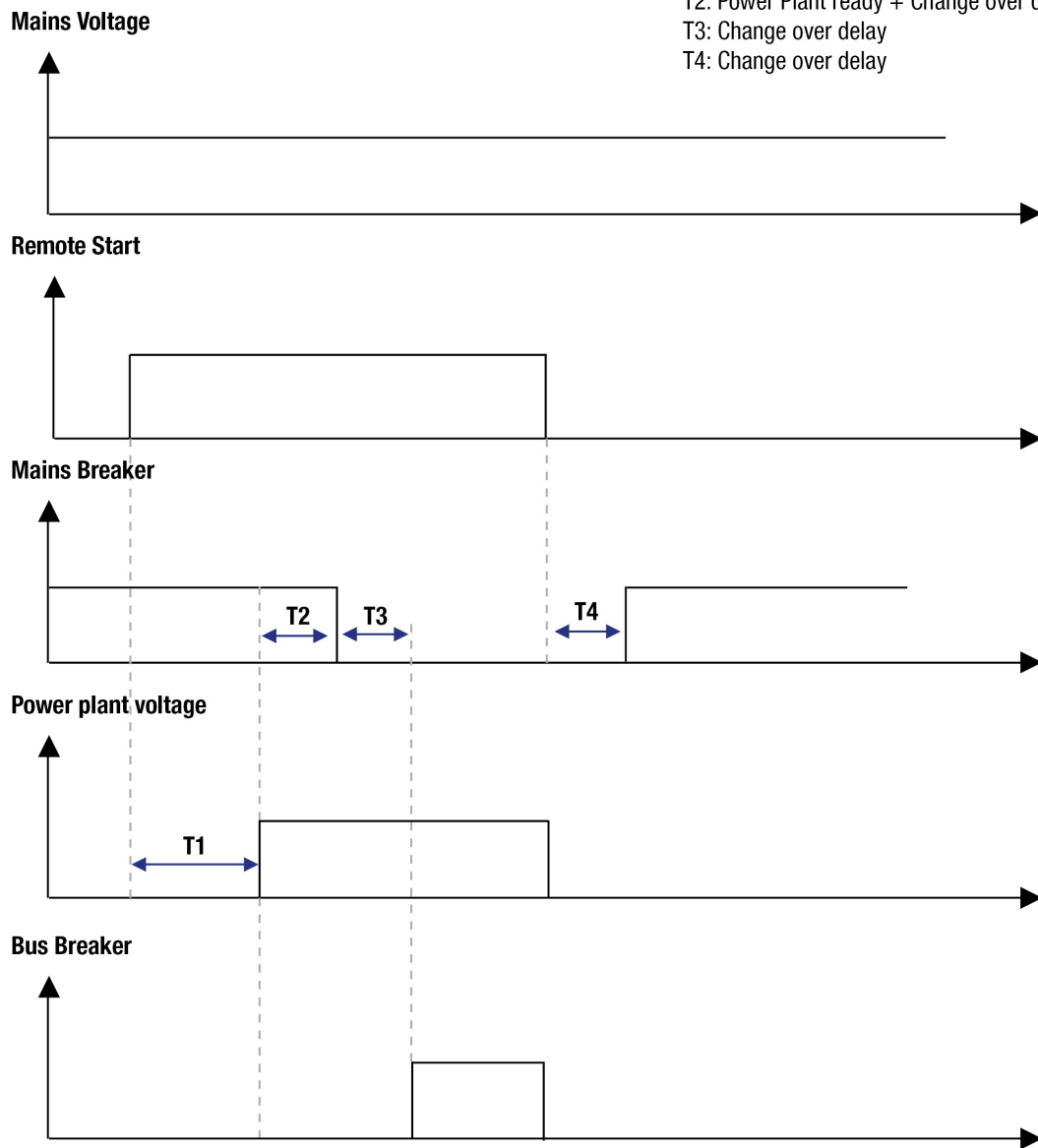

Settings

Variables	Label	Description
[2005]	<i>Type of application</i>	This parameter is used to select the mode of operation between the generator(s) and the mains. 3 values can be selected: - Change over : Load transfer between the generator(s) and the mains without synchronization/paralleling. - No break change over : Load transfer between the generator(s) and the mains with synchronization/paralleling/progressive power transfer. - Permanent: Synchronization/paralleling to the mains permanently. This mode has to be selected to set a fixed power to the mains (Peak shaving) or to set a fixed power to the generator (Base load). Caution: In this mode of operation, the activation of the df/dt protection is strongly recommended to detect the loss of the mains during permanent paralleling.
[2009]	<i>Mains back timer</i>	Waiting time between the moment when the mains returns (no longer any protection configured as mains failure is active) and the moment when the sequence to return to the mains is started.
[2007]	<i>Change over timer</i>	This timer corresponds to the waiting time between the opening of the generator/bus breaker and the closing of the mains breaker or vice versa.
[2000]	<i>Number of GENSYS COMPACT PRIME</i>	Number of GENSYS COMPACT PRIME on the power plant. This parameter is used for the CAN communication between products.
[2108]	<i>Power plant minimum kW</i>	Minimum active nominal power needed to consider the power plant ready
[2109]	<i>Power plant minimum number of GE</i>	This parameter defines the minimum number of generators required to consider the power plant ready. The controller will close the bus breaker as soon as the number of generators on the bus is greater than or equal to the value set in this parameter. To magnetize the transformer, set this parameter to 0 (to close the bus breaker before the generator breakers) and configure the GENSYS COMPACT PRIME in static paralleling.



Note: In order for the module to correctly control the Power plant (which is controlled with **GENSYS COMPACT PRIME** units), the parameter [2017] must be correctly configured in each **GENSYS COMPACT PRIME** unit. Each **GENSYS COMPACT PRIME** unit must be in **AUTO** mode without a remote start input activated.



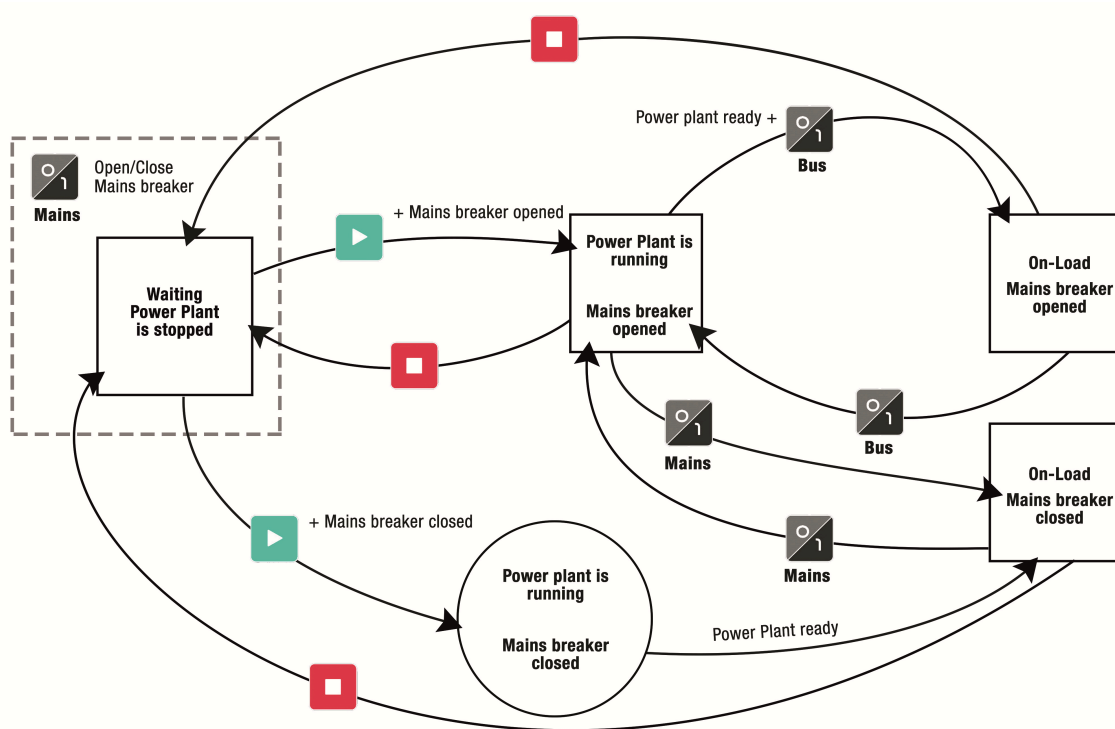

Operating mode

MAN

Figure 30. Change over : operating mode diagram





Supplying the load with Power plant

1. Press : the associated LED lights up.
2. Press : the module orders the Power plant to start.
3. Press  (Mains breaker) to open the Mains breaker (assuming the load is supplied from the Mains at the start of operation).
4. Press  (Bus breaker) to order the generators to load (only possible if the Mains circuit breaker is open).

Switching back the load to the Mains

The Power plant powers the load.

1. Press  (Bus breaker) so that the Power plant is no longer under load; the Power plant continues to run.
2. Press  (Mains breaker) to close the Mains breaker (only possible if the Bus breaker is open).
3. Press  to stop the Power plant.

AUTO

The **AUTO** mode requires the use of a digital input configured as *Remote start on load*.

NO BREAK CHANGE OVER

When the remote start is on, the Power plant starts, synchronizes, parallels to the Mains when it is ready (configurable with the parameters [2108] and [2109]) and then takes the load (load ramp). Once the Mains is unloaded, the module opens the Mains breaker as described in the following figure:

Figure 31. No break change over with remote start

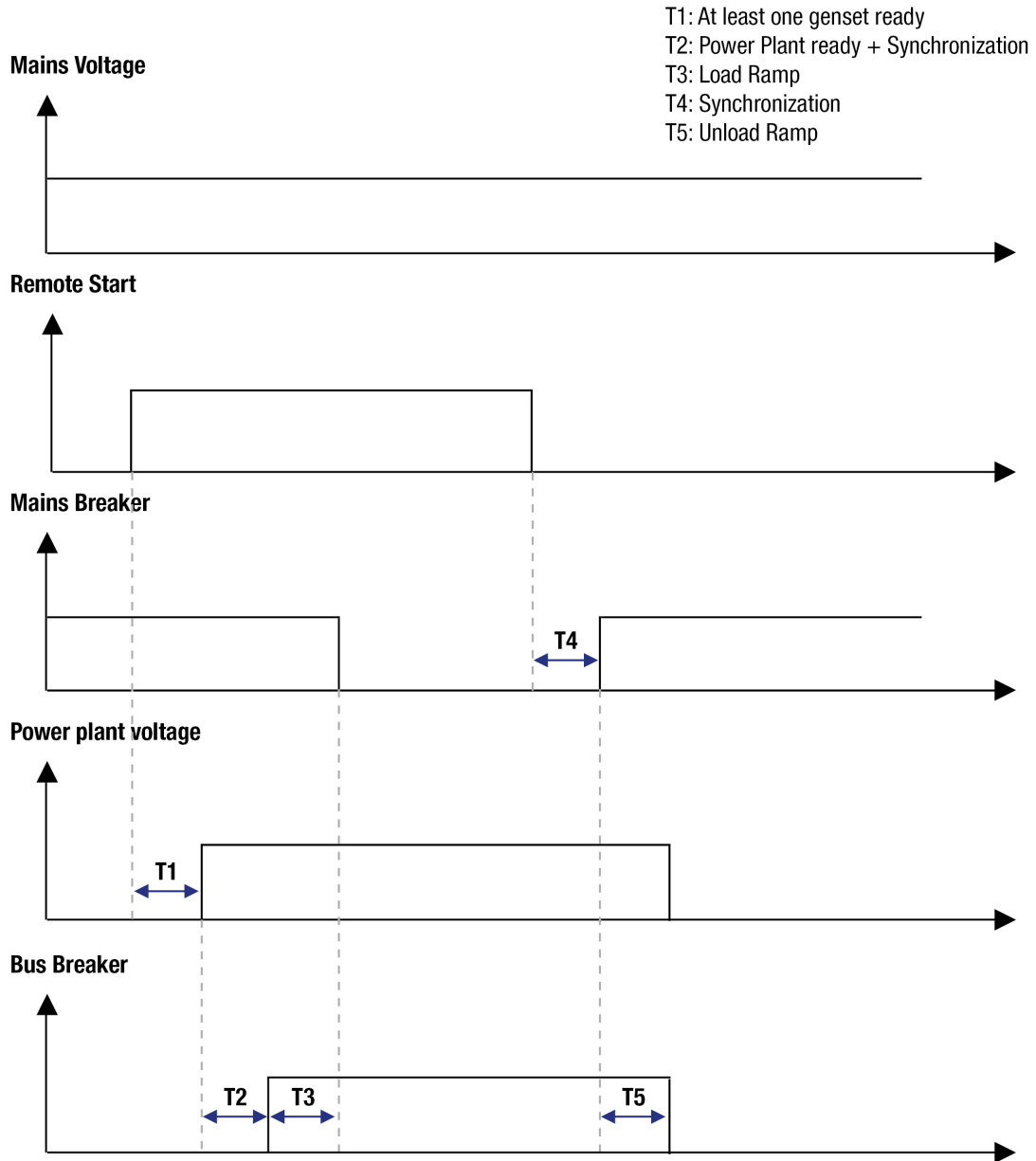

When the remote start is off, the module synchronizes the Power plant to the Mains, closes its Mains breaker, parallels with the Power plant and order the Mains to take the load. The module then opens its Bus breaker as described below:

When the remote start is off, the Mains takes the load in the same way as the Generator did previously. If the generator(s) started because of a Mains failure, the module synchronizes the generator(s) to the Mains when the Mains power returns, closes its Mains breaker, transfers the load from the generator to the Mains (unload ramp), opens the generator breaker(s) and stops the generator(s) as described below:

Figure 32. No break change over when the remote start is off

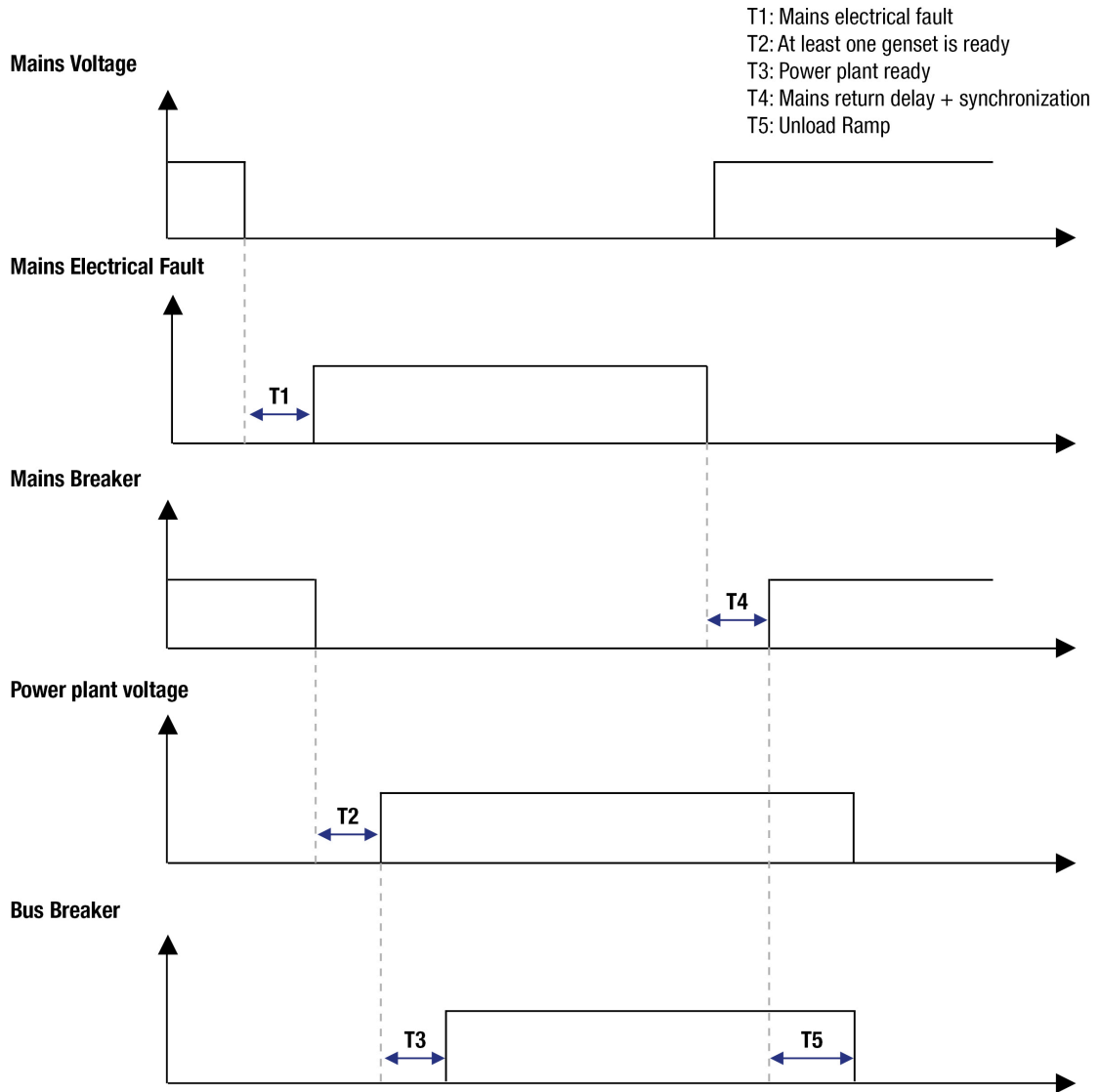

Settings

Variables	Label	Description
[2005]	<i>Type of application</i>	This parameter is used to select the mode of operation between the generator(s) and the mains. 3 values can be selected: - Change over : Load transfer between the generator(s) and the mains without synchronization/paralleling. - No break change over : Load transfer between the generator(s) and the mains with synchronization/paralleling/progressive power transfer. - Permanent: Synchronization/paralleling to the mains permanently. This mode has to be selected to set a fixed power to the mains (Peak shaving) or to set a fixed power to the generator (Base load). Caution: In this mode of operation, the activation of the df/dt protection is strongly recommended to detect the loss of the mains during permanent paralleling.
[2253]	<i>Power factor set-point (inductive)</i>	This parameter is used to set the generator/power plant $\cos(\varphi)$ set point that will be applied when paralleling to the mains. The imposed $\cos(\varphi)$ is an inductive $\cos(\varphi)$.
[2009]	<i>Mains back timer</i>	Waiting time between the moment when the mains returns (no longer any protection configured as mains failure is active) and the moment when the sequence to return to the mains is started.
[2108]	<i>Power plant minimum kW</i>	Minimum active nominal power needed to consider the power plant ready
[2109]	<i>Power plant minimum number of GE</i>	This parameter defines the minimum number of generators required to consider the power plant ready. The controller will close the bus breaker as soon as the number of generators on the bus is greater than or equal to the value set in this parameter. To magnetize the transformer, set this parameter to 0 (to close the bus breaker before the generator breakers) and configure the GENSYS COMPACT PRIME in static paralleling.



Note: In order for the module to correctly control the Power plant (which is controlled with **GENSYS COMPACT PRIME** units), the parameter [2017] must be correctly configured in each **GENSYS COMPACT PRIME** unit. Each **GENSYS COMPACT PRIME** unit must be in **AUTO** mode without a remote start input activated.

Operating mode

MAN

Figure 33. No break change over : operating mode diagram

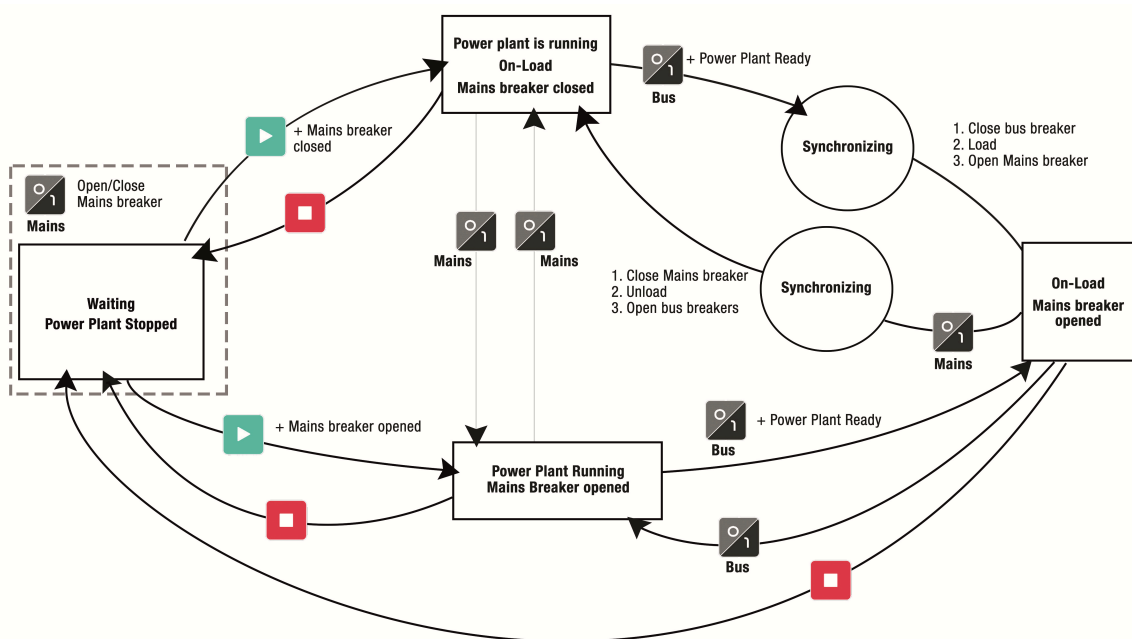

Note: The **MAN** mode does not allow manual control of speed and voltage to synchronize or load control. Synchronization and load control are automatic even in **MAN** mode.

Supplying the load with Power plant

1. Press : the associated LED lights up.
2. Press : the module starts the Power plant. The power plant's generators close their breakers.
3. Press (Bus breaker) to synchronize the Power plant to the Mains, start a load ramp and open the Mains circuit breaker.

Switching back the load to the Mains

The Power plant is on load:

1. Press (Mains breaker) to synchronize the Power plant to the Mains, start an unload ramp and open the Bus circuit breaker.
2. Press to order the Power plant to stop.

AUTO

The **AUTO** mode requires using a logic input configured as **Remote start**. All sequences are managed automatically, as on the previous picture.

Failure to synchronize

After a Mains fault, the Power plant is alone on the load. When the Mains comes back and the return to Mains temporization is over, the module tries to synchronize the Power plant to the Mains.

If a failure to synchronize is configured as Fault (soft shutdown), the Bus breaker opens and the Mains breaker closes.

Operator controlled return to mains

Normal operation: In case of Mains failure, the Power plant starts and takes the load. When the Mains voltage returns, the Power plant re-synchronizes to the Mains and automatically gives back the load.

The "**Operator controlled return to mains**" special function allows the operator to control the moment the Power plant will return the load to the Mains.

To do this, a digital input of the module should be set as "**Manual mains back**". The unit will wait the synchronization order provided by the digital input before re-synchronizing the Power plant to the Mains.



Note: If the synchronization order is issued by Modbus TCP, the parameter *Manual mains back* [2010] should be set to "**Yes**" (1).

PERMANENT

Figure 34. Permanent mode

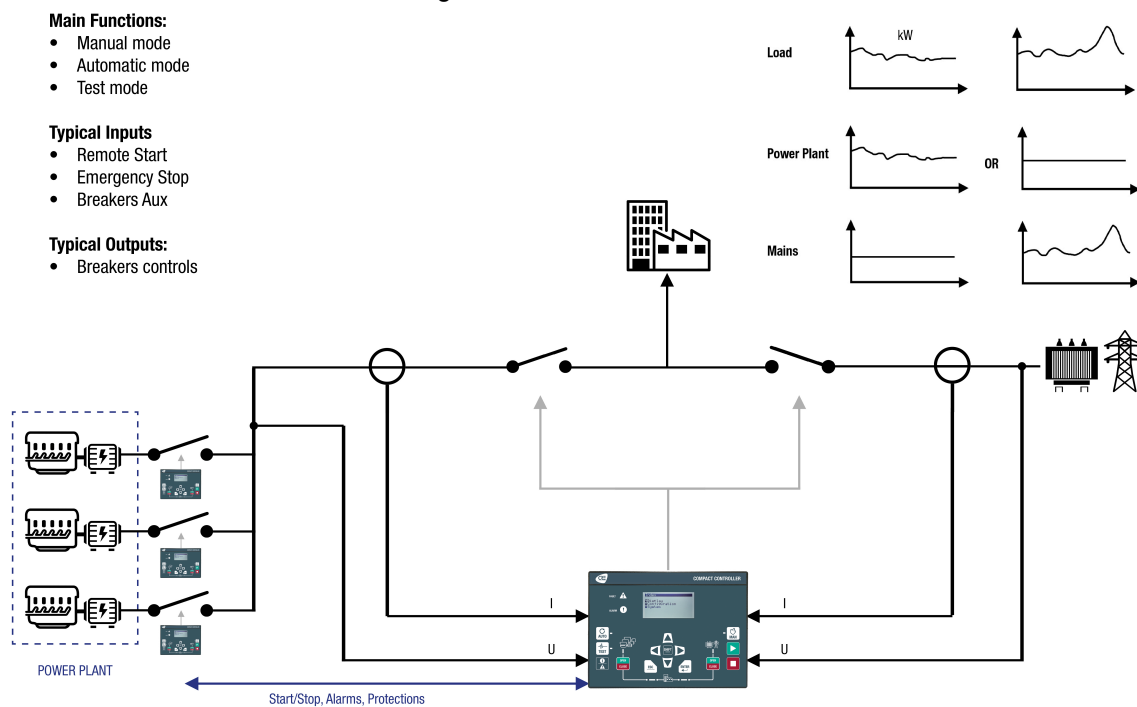

When the remote start is on, the module starts the Power plant, synchronizes and parallels the Power plant to the Mains when it is ready (configurable with the parameters [2108] and [2109]), then ramps up load until it reaches its setpoint.

On base load mode, the Power plant has a constant load and the Mains takes the load variations. If the load is less than the Power plant set-point, the Mains is in reverse power

In the peak shaving mode, the Mains has a constant load and the Power plant takes the load variations.

Settings

Variables	Label	Description
[2005]	<i>Type of application</i>	This parameter is used to select the mode of operation between the generator(s) and the mains. 3 values can be selected: - Change over : Load transfer between the generator(s) and the mains without synchronization/paralleling. - No break change over : Load transfer between the generator(s) and the mains with synchronization/paralleling/progressive power transfer. - Permanent: Synchronization/paralleling to the mains permanently. This mode has to be selected to set a fixed power to the mains (Peak shaving) or to set a fixed power to the generator (Base load). Caution: In this mode of operation, the activation of the df/dt protection is strongly recommended to detect the loss of the mains during permanent paralleling.
[2006]	<i>Type of regulation</i>	This parameter is used to select the type of consignment when the generator(s) is(are) permanently paralleled to the mains. 2 values can be selected: - Peak shaving : Fixed active power on the mains, the active power of the generator(s) changes with the load. If the generator(s) reach(s) the high limit, the mains consignment will no longer be respected. - Base load : Fixed active power on the generator(s), the active power of the mains changes with the load.
[2253]	<i>Power factor setpoint (inductive)</i>	This parameter is used to set the generator/power plant $\cos(\varphi)$ set point that will be applied when paralleling to the mains. The imposed $\cos(\varphi)$ is an inductive $\cos(\varphi)$.
[2154]	<i>Peak shaving kW setpoint</i>	This parameter is used to set the active power setpoint of the mains when the product is configured in peak shaving mode.
[2107]	<i>Base load Generator(s) kW setpoint</i>	This parameter is used to set the active power setpoint of the generator/power plant when the product is configured in base load mode.
[2009]	<i>Mains back timer</i>	Waiting time between the moment when the mains returns (no longer any protection configured as mains failure is active) and the moment when the sequence to return to the mains is started.
[2108]	<i>Power plant minimum kW</i>	Minimum active nominal power needed to consider the power plant ready
[2109]	<i>Power plant minimum number of GE</i>	This parameter defines the minimum number of generators required to consider the power plant ready. The controller will close the bus breaker as soon as the number of generators on the bus is greater than or equal to the value set in this parameter. To magnetize the transformer, set this parameter to 0 (to close the bus breaker before the generator breakers) and configure the GENSYS COMPACT PRIME in static paralleling.



Note: In order for the module to correctly control the Power plant (which is controlled with **GENSYS COMPACT PRIME** units), the parameter [2017] must be correctly configured in each **GENSYS COMPACT PRIME** unit. Each **GENSYS COMPACT PRIME** unit must be in **AUTO** mode without a remote start input activated.

Operating mode

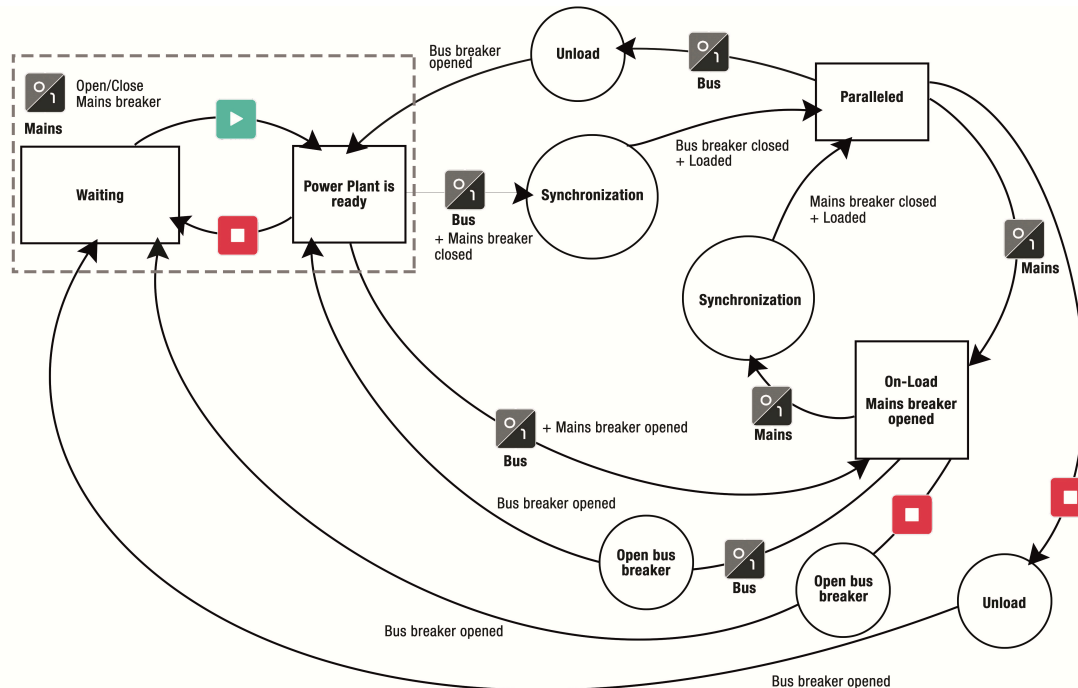

MAN

Figure 35. Permanent : operating mode diagram





Note: The **MAN** mode does not allow manual control of speed and voltage to synchronize or load control. Synchronization and load control are automatic even in **MAN** mode.

Supplying the load with Power plant

1. Press  : the associated LED lights up.
2. Press  : the module orders the Power plant to start and close its Generator breakers.
3. Press  (Bus breaker) to synchronize the Power plant to the Mains and do a load ramp to the KW set-point (Bus KW setpoint in Base load mode or Mains KW setpoint in Peak shaving mode) when it is ready.

Switching back the load to the Mains

The Power plant is in parallel with the Mains and provides active power according to its configuration

1. Press  (Bus breaker) to do an unload KW ramp and open the Bus circuit breaker.
2. Press  to order the Power plant to stop running and open its Generator breakers.

AUTO

The **AUTO** mode requires using a logic input configured as **Remote start**. All sequences are managed automatically, as on the previous picture.

Failure to synchronize

After a Mains fault, the Power plant is alone on the load. When the Mains comes back and the return to Mains temporization is over, the module tries to synchronize the Power plant to the Mains.

If a failure to synchronize is configured as Fault (soft shutdown), the Bus breaker opens and the Mains breaker closes.

Operator controlled return to mains

Normal operation: In case of Mains failure, the Power plant starts and takes the load. When the Mains voltage returns, the Power plant re-synchronizes to the Mains and automatically gives back the load.

The "**Operator controlled return to mains**" special function allows the operator to control the moment the Power plant will return the load to the Mains.

To do this, a digital input of the module should be set as "**Manual mains back**". The unit will wait the synchronization order provided by the digital input before re-synchronizing the Power plant to the Mains.



Note: If the synchronization order is issued by Modbus TCP, the parameter *Manual mains back* [2010] should be set to "**Yes**" (1).

MULTIPLE MAINS

General information

Figure 36. Multiple mains

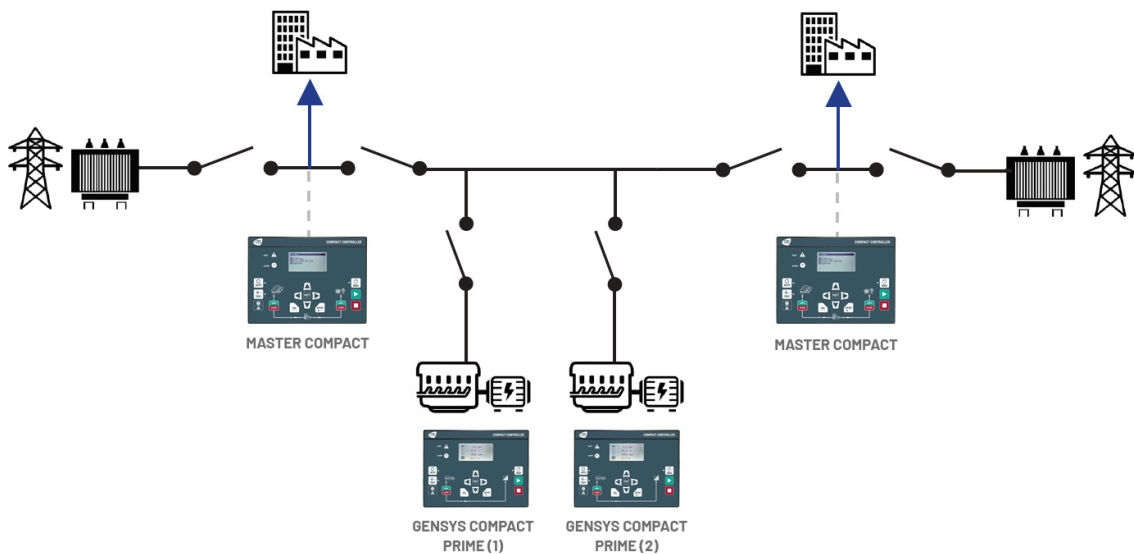

The **MASTER COMPACT** controllers can handle most of the multiple mains applications. If **MASTER COMPACT 1B** controllers are used to manage a multiple mains application, an external PLC is required to manage all desired sequences.

All **MASTER COMPACT** controllers communicate with each other to ensure that Mains are never paralleled (except in **MAN** mode).

There are 2 different cases in which the **MASTER COMPACT** units communicate with each other in order to avoid paralleling between multiple Mains:

1. The generators are stopped, each Mains provides KW to its load. In this case, if the remote start of the **MASTER COMPACT** units are activated at the same time (less than 2 seconds between each activation), the **MASTER COMPACT** units communicate with each other so that the first to perform its sequence is the one with the lowest number. The global sequence will always be **MASTER COMPACT 1, MASTER COMPACT 2, MASTER COMPACT 3, etc...**
2. The 2 Mains circuit breakers are open. The 2 loads are supplied by the generators. In this case, if the remote start of the **MASTER COMPACT** units are disabled at the same time (less than 2 seconds between each deactivation), the **MASTER COMPACT** units communicate with each other so that the first to perform its sequence is the one with the highest number. The global sequence will always be **MASTER COMPACT XX, ..., MASTER COMPACT 3, MASTER COMPACT 2, MASTER COMPACT 1, etc...** The rule is the same when multiple Mains reappear simultaneously.

Here are several rules to respect which depend on the 2 cases seen above:

- The number of each **MASTER COMPACT** is not important if all **MASTER COMPACT** controllers are configured in no break change over mode.
- In the case of several **MASTER COMPACT** (2 circuit-breakers), there can only be one **MASTER COMPACT** in permanent mode. The **MASTER COMPACT** which is in permanent mode must have the highest number in order not to block the sequence (the Mains cannot be in parallel).
- The **MASTER COMPACT** controllers perform their sequence immediately no matter the number of the controllers since there is no risk of paralleling between the Mains.

Settings

Variables	Label	Description
[2001]	<i>My number</i>	Parameter used to prioritize the sequences of the MASTER COMPACT controller.
[2005]	<i>Type of application</i>	Only 1 MASTER COMPACT controller in permanent mode per application. Must have the highest number [2001].

ADVANCED FUNCTIONS

EASY FLEX®

Easy Flex® offers a simple and innovative programming mode, allowing you to adapt the controller to your needs. Its consists of several types of instructions that can be completed with variables and operators to add specific behaviours to the controller.

Variables

The **Easy Flex®** page has an area that contains the list of variables that can be used in the variable fields of the different instructions. Click on the **Variables** tab to display the list of variables.

Figure 37. Easy Flex® list of variables

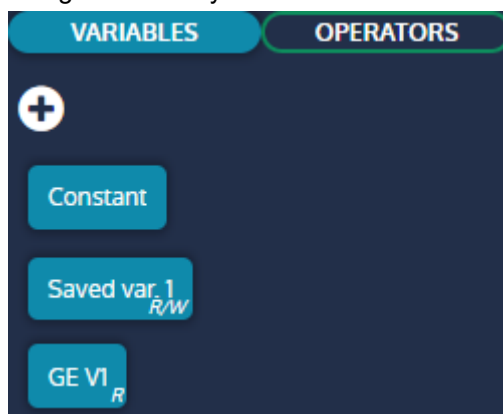

Constant block

A Constant block is defined by default and must be used when a constant value is required in an instruction.

Variable block

The variables of the controller can be added to the area as variable blocks. This blocks can then be used in the different instructions. there are two types of variable:

- **Read/Write:** Can be used in the read only (R) or write (W) variable fields of an instruction
- **Read only:** Can only be used in the read only (R) variable fields of an instruction (marked with the R letter)

Figure 38. Using read only and read/write variables



How to add a variable block

To add a variable block to the variables area:

1. Click on the plus button to open the variables search engine
2. Click on a variable with a plus icon
3. Close the search engine

The variable block should now be visible in the area.

Figure 39. Adding a variable block to the Easy Flex® variables area

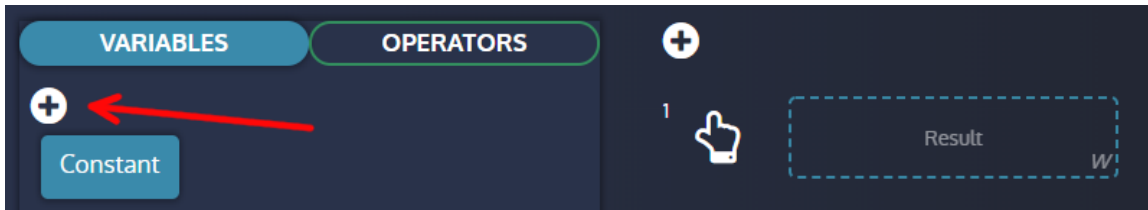

How to use a variable block in an instruction

To use a variable block in an instruction:

1. Hold the click on the variable block to be used
2. Move the variable block to a variable field of an instruction
3. Release the click to drop the variable block in the field

The variable now belong to the instruction and will be interpreted by it.

Figure 40. Drag and drop of a variable in an instruction



Operators

The **Easy Flex®** page has an area that contains the list of operators that can be used in the operator field of the different instructions. Click on the **Operators** tab to display the list of operators.

Figure 41. Easy Flex® list of operators



Test operator

A test operator return a **boolean** value in the result variable.

Calculation operator

A calculation operator return an **analog** value in the result variable.

How to use an operator block in an instruction

To use an operator block in an instruction:

1. Hold the click on the operator block to be used
2. Move the operator block to the operator field of an instruction
3. Release the click to drop the operator block in the field

The operator now belong to the instruction and will be interpreted by it.

Figure 42. Drag and drop of an operator in an instruction

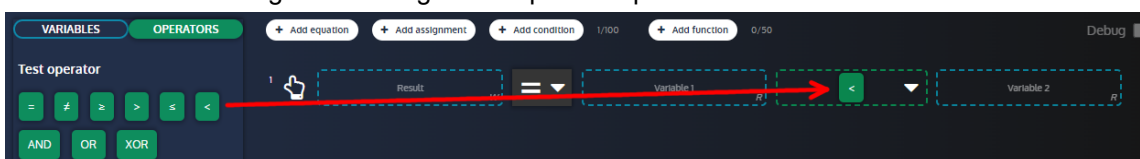

Instructions

There are many types of instructions available in **Easy Flex®**.

Equations

The **equation** instruction is an operation between two variables whose result is stored in a result variable.

Click on the **Add equation** button to add a new equation. A counter is displayed beside the button to indicate the number of equations defined and the maximum number of equations allowed.



Note: The counter is common to the equations, assignments and conditions.

Figure 43. Example of equation



NOT

When a variable field of an equation is filled with a variable block and the operator field is filled with a test operator, it is possible to add a NOT function to the variable to revert its boolean value.

How to set a NOT

To set a NOT function:

1. Click on the arrow beside the variable block
2. Click on the NOT checkbox to enable/disable the function

Figure 44. Setting the NOT function of a variable block



Timer ON/Timer OFF

When the operator field of an equation is filled with a test operator, it is possible to add a Timer ON function to delay the update of the result when the test operation is true. Following the same principle, it is also possible to add a Timer OFF to delay the update of the result when the test operation is false.

How to set a Timer ON/Timer OFF

To set a Timer ON/Timer OFF function:

1. Click on the arrow beside the operator block
2. Set the Timer ON value in the input (in seconds) and toggle the checkbox to enable/disable the function
3. Set the Timer OFF value in the input (in seconds) and toggle the checkbox to enable/disable the function

Figure 45. Setting the Timer ON/Timer OFF function of a variable block



Type of assignment

When the operator field of an equation is filled with a test operator, it is possible to change the type of assignment:

- **Equal:** The result of the test operation is stored in the result variable
- **Set:** The result variable is set only when the test operation becomes true
- **Reset:** The result variable is reset only when the test operation becomes true

How to set the type of assignment

To set the type of assignment:

1. Click on the type of assignment list to display the list items
2. Click on the type of assignment you want

Figure 46. Setting the assignment type of an instruction



Assignments

The **assignment** instruction assigns the value of a variable to a result variable.

Click on the **Add assignment** button to add a new assignment. A counter is displayed beside the button to indicate the number of assignments defined and the maximum number of assignments allowed.

 **Note:** The counter is common to the equations, assignments and conditions.

Figure 47. Example of assignment



Conditions

The **condition** instruction executes a group of instructions according to a test condition. As for equations, the NOT, Timer ON and Timer OFF functions can be used in the condition instruction.

Click on the **Add condition** button to add a new condition. A counter is displayed beside the button to indicate the number of conditions defined and the maximum number of conditions allowed.

 **Note:** The counter is common to the equations, assignments and conditions. The maximum number of instructions per condition is 10.

How to add/remove instructions to a condition

- Drag and drop instructions into the condition to add them to the condition
- Drag and drop an instruction out of the condition to remove it from the condition

Figure 48. Adding an instruction to a condition



Functions

The **function** instruction allows you to group instructions together and to assign a title and a description to this group.

Click on the **Add function** button to add a new function. A counter is displayed beside the button to indicate the number of functions defined and the maximum number of functions allowed.

Add existing instructions to a function

Drag and drop an existing instruction into the function to add it in.

Figure 49. Adding an instruction to a function

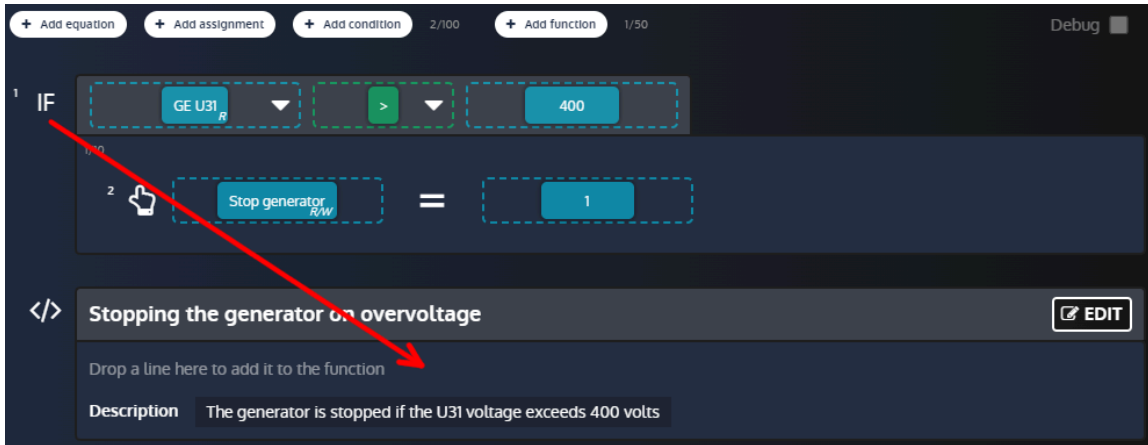

Edit a function

Click on the Edit button of a function to open the editing window:

1. Type in the title field to edit the title of the function (up to 100 characters per title for each function).
2. Type in the description field to edit the description of the function (up to 12500 characters shared across all functions).
3. Use the **Add** buttons to add new instructions to the function.
4. Drag and drop an instruction into the dotted area to move it out of the function.
5. Click on the **Save/Back** button to save the parameters of the function and to close the editing window.

Figure 50. Editing a function

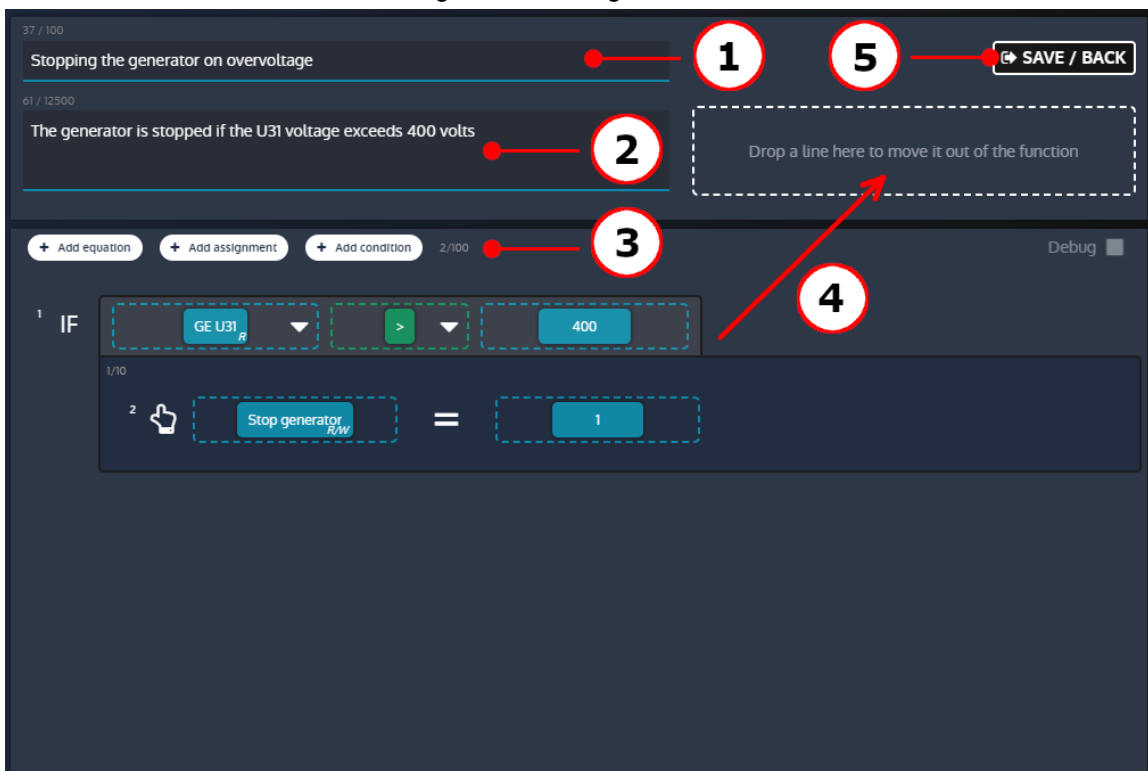

Moving a bloc or an instruction

The declared blocks and instructions can be moved using drag and drop:

- Operators and variables blocks can be move from a line to another
- Any instruction can be moved above or below other instructions to change the execution order

Deleting a bloc or an instruction

Blocks and instructions can be deleted in different way. To delete a block or instruction:

- Drag and drop the element to delete into the **Trash** area
- Click on the element to delete and click on the **Trash** area
- Click on the element to delete and press the **Delete** key of the keyboard

Figure 51. Deleting an instruction through drag and drop

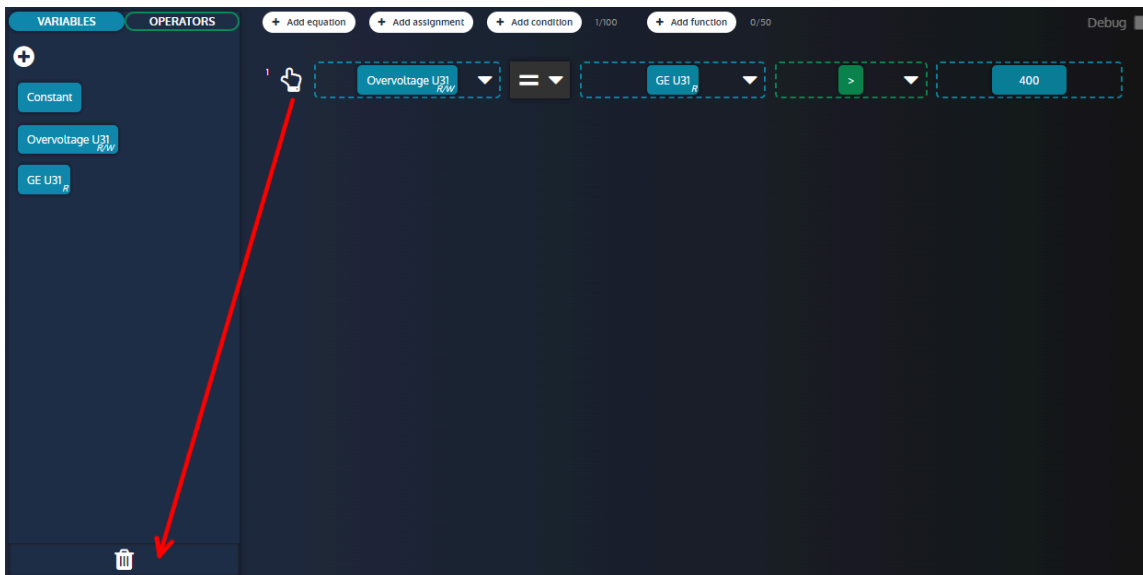

Confirm/Cancel your changes

Once you are done setting the various instructions, you can confirm or cancel your changes.

- To confirm your changes, click on the confirm button



- To cancel your changes, click on the cancel button



Debug mode

It is possible to activate a debug mode to watch in real time the values of the variables used in the **Easy Flex®** lines. Toggle the check box to enable/disable the debug mode. The debug mode can't be activated while modifications are in progress. Modifications can't be done while debug mode is activated.

Figure 52. Easy Flex® debug mode

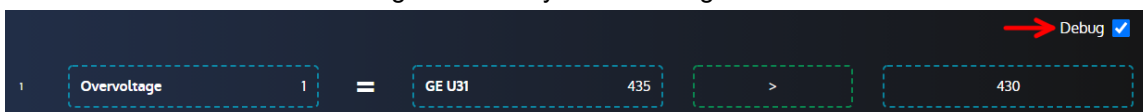

Warnings with Easy Flex®

Variable [4214] *Easyflex error code* provides more information in case of an **Easy Flex®** warning alarm. Its value is calculated with the following formula:

$$[4214] = (100 * \text{line concerned}) + \text{type of error}$$

List of different types of errors:

Error 1

Operand 1 or 2 is invalid.

Error 2

Unknown operator.

Error 3

The result variable is empty.

Error 4

The result variable is read-only.

Error 5

The result is outside the range of the target variable.

Error 6

Overflow on at least one equation.

Error 7

Division by 0.

USER VARIABLES

A range of user variables is available to be used in equations.

Starting from the firmware version 2.22, this range has been split into two sub-ranges:

- Saved user variables [8000] to [8049]
- Unsaved user variables [8050] to [8099]

Unsaved user variables values are lost when the module's power supply is switched off while Saved user variables values are saved in a non volatile memory so their values are kept even in case of power loss.

Prefer using Unsaved user variables for better performance if you don't need to save the value of a data in case of power cycling. Otherwise, Saved user variables and Unsaved user variables share the same behaviour as is described below.

User variables properties

Each property of a user variable can be set.

- Label
- Unit
- Accuracy
- Variable type. It defines the way you want to use the user variable:
 - For equations
 - To trigger alarms or faults (depending on the variable type value)



Note: Label, unit and accuracy will change the display of the user variable in the information page.

User variable used for equations

The variable can be used:

- To store the result of an equation line (to be used in another equation line, to be displayed in the information page, to be read by modbus...).
- As an operand in an equation line.

User variable used to trigger alarms and faults

In that case, the value of the user variable is used to trigger an alarm or a fault according to the user variable value:

- If the user variable = 0, the alarm/fault is not active.
- If the user variable > 0, the alarm/fault is active and is displayed in the alarms/faults log (with the label set before).

ALTERNATIVE SELECTION

The **Alternative selection** page offers a supplement to **Easy Flex®** programming.

This function is presented as 16 selections between two values:

Figure 53. Page of the function Alternative selection

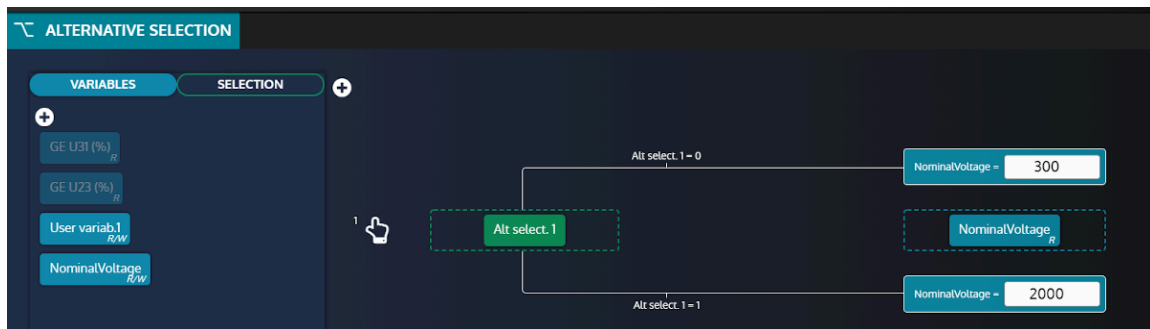

Adding variables

To add new variables from the list of variables, click on the "+" button in the "Variables" tab(see below) :

Figure 54. Adding variables button



Use the **search engine** to find and select the variables you want to use.

Adding selections

Selection variables are **booleans** (0 or 1) used to assign different values to the associated parameter (see below):

Figure 55. Equation block definition

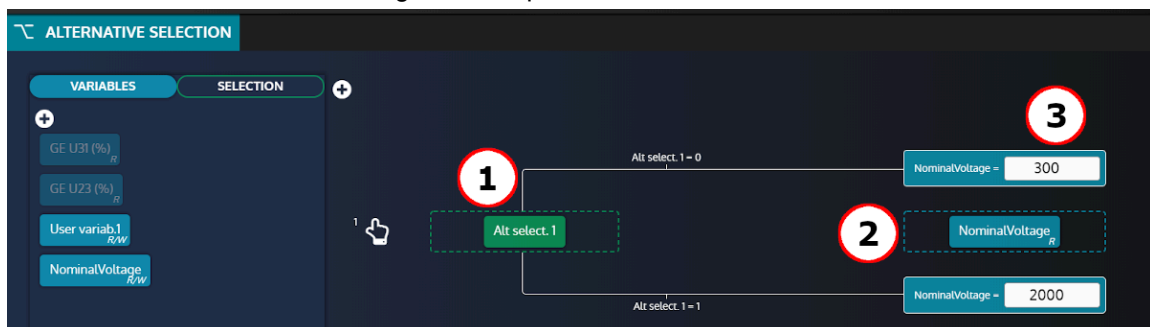

1. Selection variable (one among the 16 proposed in the SELECTION section).
2. Associated parameter.
3. Value to assign to the associated parameter depending on the value of the selection variable

Using the example above, **NominalVoltage** parameter will take 2 different values depending on **Alt select 1** :

- When **Alt select 1 = 0** then **NominalVoltage** will be set to **300**.
- When **Alt select 1 = 1** then **NominalVoltage** will be set to **2000**.



Note: If a variable is set in the "Alternative selection" mode, modifying its value from the front face, via Modbus or any other source will always result of the overwrite of the value by the "Alternative selection" mode.

SCHEDULER

The scheduler can activate any function that can be controlled by a digital input. These functions can be activated one or many times.

Scheduled items are presented as a list. Each line (item) in this list corresponds to a scheduled event.

Scheduler list

In the **Controller settings** ⇒ **Programming** ⇒ **Scheduler (i4Gen)** page, you will have access to all events that you created.

Figure 56. Scheduler icons definition

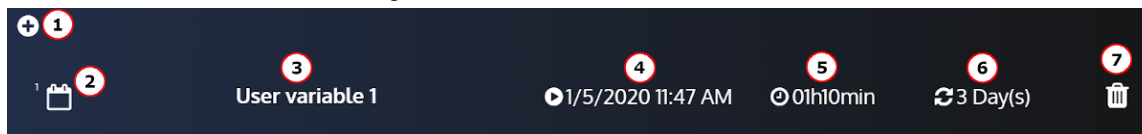

1. Add an event.
2. Number of the event.
3. Active function during the event.
4. First time the event will take effect.
5. Duration of the event.
6. Frequency.
7. Delete the event.

It is also possible to have an event without periodicity. The event will occur only once:

Figure 57. Scheduler with an event without periodicity

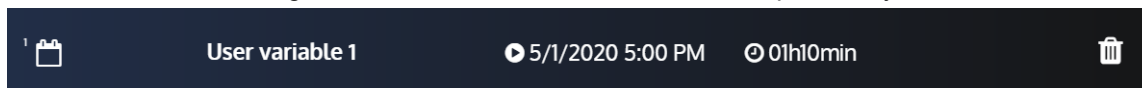

Scheduler settings

By clicking on the event you want to modify, you will have access to these parameters which will allow you to configure the event:

Figure 58. Form of the scheduler

The screenshot shows a dark-themed configuration form for a scheduler. It consists of several rows, each with a label on the left and a control element on the right. The controls are: a text input for 'Function' containing 'Led test'; a date/time input for 'Starting date/time' containing '4/17/2019 - 11:47 AM'; two numeric inputs for 'Duration' (24 and 10) with 'h' and 'min' labels; a dropdown menu for 'Periodicity' set to 'Daily'; and a numeric input for 'Every' set to '1' with 'Day(s)' label. At the bottom are two buttons: a green square with a white checkmark and a red square with a white 'X'. Red circles with numbers 1 through 6 are overlaid on the form to indicate specific points of interest.

1. Function active during the event.
2. First date and time the event will take effect.
3. Duration of the event.
4. Expected periodicity (Only once or period on a daily, weekly, monthly basis).
5. Setting the repetition of the periodicity (X period (s)).
6. Confirm or cancel the event settings.

Scheduler supervision

Available in the **Controller supervision** ⇒ **Scheduler (i4Gen)** page.

Figure 59. Scheduler supervision

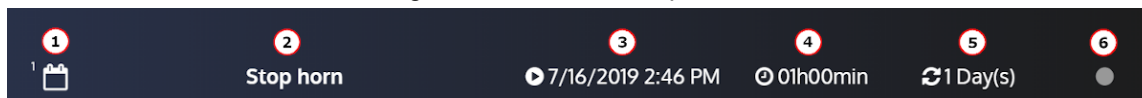

1. Number of the event.
2. Function active during the event.

3. The next time the event will take effect (the value can be different from the configuration because this one is actualised).
4. Duration of the event.
5. Periodicity.
6. Indicator On / Off.

MODBUS TCP MAPPING

Configurable block

To create your own Modbus blocks, use variables [10000]...[10299] in the **Controller settings** ⇒ **Programming** ⇒ **Modbus** ⇒ **Modbus redirection (i4Gen)** page.

There are two ways to configure these blocks:

1. Configuration in the **Controller settings** ⇒ **Programming** ⇒ **Modbus** ⇒ **Modbus redirection (i4Gen)** page: enter the codes of the variables to read; Modbus readings on registers [10000]...[10299] will be the values of the pointed variables.
2. Configuration by an external device; this device must follow the following steps:
 - Write 1 in the variable [3016] to enter the modbus redirection configuration mode.
 - Write the codes of the variables to be read to the desired registers ([10000]...[10299]).
 - Write 0 in the variable [3016] to switch back to the modbus redirection display mode.

You can then read your own block, by reading the registers [10000]...[10299] through Modbus TCP.

Example:

If the configuration is as follows [10000] = 14; [10001]=15; [10002]=16, reading these 3 registers through Modbus TCP will give you the hours/minutes/seconds of the module (respectively the values of variables [14], [15] and [16]).

LOGGER

The **Logger** tool is used to track value or status changes up to 10 variables at the user's choice.

The variable *State* is always recorded as long as the Logger is not set to Off.

This function is available in the **Controller settings** ⇒ **Programming** ⇒ **Logger** ⇒ **Activation (i4Gen)** page.

Logger recording modes

Several modes are available to capture events depending on the Generator status:

Off

No recording of selected variables

Always ON

FIFO recording of selected variables until the Logger is Off.

Post starting

FIFO recording of selected variables when the Generator is running.

Stabilized

FIFO recording of selected variables as long as the Generator is in a stabilized state.

Additional Functions

For each variable you can set a log period down to the second (example: 1s).

To use this function, select **Interval** in the **Log variable 1 on** field.

The **Erase Logger** button will delete all recorded variables from the module.

A lot of variables can be recorded. The list of the available variables can be found in the [Software variables \(on page 112\)](#) appendix.

COMMUNICATIONS

NETWORK

Setting up PC connection

Materials required:

- A CAT 5 cross Ethernet cable (marked CROSSOVER CABLE along its sheath) for direct connection to the module from your computer.
- A CAT 5 straight Ethernet cable (marked PATCH CABLE or STRAIGHT-THROUGH CABLE along its sheath) can only be used with an Ethernet switch.

Configuring the computer IP address

1. Connect the module with a 100Ω Ethernet cord
Direct connection to PC: use a crossover cord. Connection through a switch: you can use either a direct or a crossover cable such as 3-m long A53W1, as long as your switch uses auto MDI/MDIX technology.
2. Power up the module using a stabilized power supply.
3. Open Windows control panel
4. Open the network interface properties window. For this do the following steps:
 - a. Open the page **Network and Sharing Center**
 - b. Click on **Change adapter settings**
 - c. Right click on your network interface and select **Properties** (Windows 7 and above)

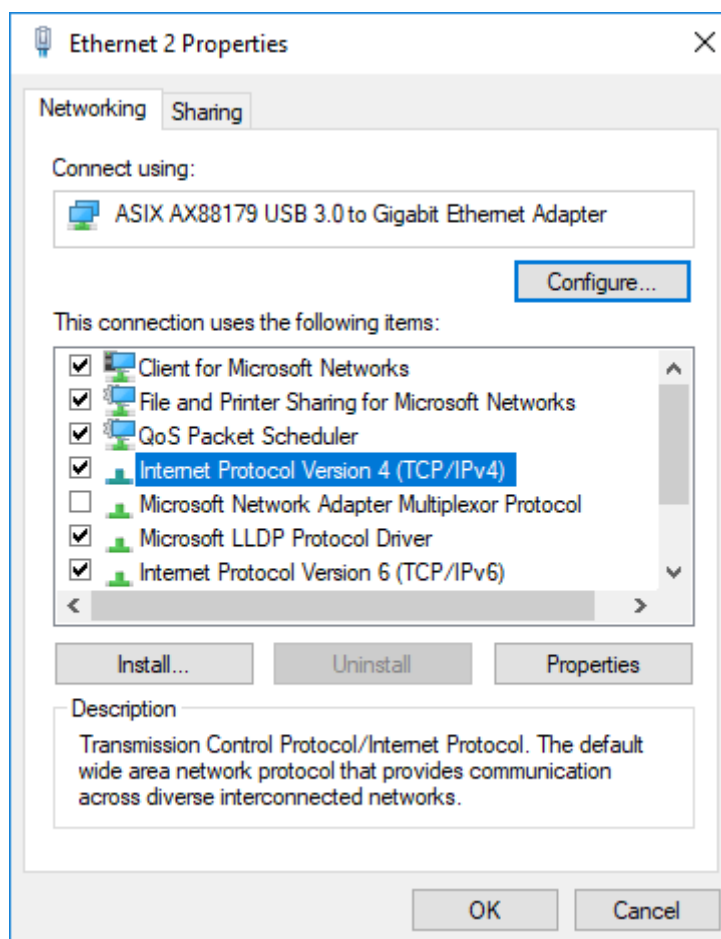

Change the IP address of the module

IP settings of the module can be modified in **Controller settings** ⇒ **System** ⇒ **Network**.

There are two different types of configuration:

- **DHCP (automatic)**: The module supports DHCP. If DHCP is enabled, the module must be connected to a network equipped with a DHCP server to obtain an IP address.
On power-up, the module obtains an IP address from the DHCP Server.
If the DHCP protocol fails, the fixed IP address of the module is used (Factory setting: 192.168.11.1).
- **Manual setup**: To manually configure the device network settings, disable the **DHCP** setting, then fill in the **IP address** and **Subnet Mask** fields.

Modbus/TCP port and HTTP port numbers can be set in both configurations.

On CORE modules, you can reset the IP address (to 192.168.11.1) by holding the button on the rear face when the module is powered on.



Note: For most networks, it is not necessary to set the gateway or to change port numbers. For complex networks, please contact your network administrator to configure your router and/or the units according to your needs.

MODBUS TCP/IP

Abilities

An Ethernet communication can be established between a Modbus master device and the controller which acts as a Modbus slave.

The complete list of variables accessed through *i4Gen* is described in the chapter [Software variables \(on page 112\)](#).

The complete list of every variable is described in the documentation **Modbus table** available in our website.

The Modbus master device can read/write many internal variables of the controller according to their access rights described below.

Type	Range	Default access right
Readings (measurements, states,..).	[0000] ... [1999]	Read only.
Parameters.	[2000] ... [3999]	Read/Write.
Modes, statuses, settings,... Readings associated with digital inputs.	[4000] ... [9999] [4500] ... [4649], [4950]...[4999]	Read. Write (subject to activation).

In addition, the following functions are supported:

- Reading bit fields, listed in a dedicated tab of the file and organized in 16-bit words. These variables are listed in the **Modbus table** documentation.
- Reading contiguous configurable data block.

Those functions allow a significant performance gain and help reducing the load on an Ethernet network.

Configuration

To communicate through Modbus/TCP, define the following settings:

- The module IP address set in the **Controller settings** ⇒ **System** ⇒ **Network** page.
- The *Modbus TCP port* [3014], generally 502, set in the **Controller settings** ⇒ **System** ⇒ **Network** page.
- The Modbus/TCP rights: see further.

The module handles up to 6 simultaneous connections. This can be used for multiple HMIs for example. For more details on the Ethernet configuration, see the chapter [Network \(on page 92\)](#).



Warning:

Connecting the controller to an *i4Gen* device or the *i4Gen Suite* software will utilize one Modbus connection.

Functions

The module supports the following Modbus functions:

Functions	Description
01, 02	Read logical data (Coil status, discrete input status).
03, 04	Read holding/input registers (16 bit).
05	Write logical value (single coil).
06	Write single register (16-bit variable).
15 (0x0F)	Write multiple logical values (multiple coils).
16 (0x10)	Write multiple registers.

All module variables are 16-bit registers. Yet it might be useful to consider them as logical values (if they are only set to 0 or 1) to simplify the Modbus/TCP protocol communication with some external PLC. If function 01 or 02 is used to read an internal register that is different from 0, then returned value will be 1.

The module registers start from address 0. Depending on your Modbus/TCP client equipment-software, you may need to use an offset of 1 when reading/writing registers as addresses may start from address 1. In this case, request address/register number 1 to access variable 0000 inside the module.

The 32-bit variables can only be written using 0x10 function.

If a digital input modifies a piece of data also to be written via Modbus, the latest request takes over the other.

Data [10000]...[10299] can be read by block (see further).

Access rights

The access rights depend on the parameter type and on Modbus access permissions. To manage access rights, set to 1 the corresponding bits in the register [3015]:

Description	Bit #	Default value
Writing date/ time	0	0
Writing engine counters	1	0
Not used	2	0
Writing digital input function register	3	1
Not used	4	0
Not used	5	0
Not used	6	0
Not used	7	0
Reading via Modbus/TCP	8	1
Writing via Modbus/TCP	9	1

Using the **Controller settings** ⇒ **Programming** ⇒ **Modbus** ⇒ **Modbus rights (i4Gen)** page, you can tick check-boxes to set those:

Bit #	Label	Description
0	Writing to date/ time	Module time synchronization.
1	Writing to Engine counters	Manual counters adjustment (see following table).
3	Writing to digital input function register	Opens the possibility to activate a digital input function using Modbus/TCP protocol.
8	Reading using Modbus/TCP protocol	Opens the possibility to grant reading individual permissions.
9	Writing using Modbus/TCP protocol	Opens the possibility to grant writing individual permissions.

The counters, encoded on 32 bits, include:

Meters (MSB LSB)	Label
[80] [79]	
[82] [81]	
[84] [83]	<i>Number of hours generator running</i>

Bit fields

Bit fields are meant for decreasing communication bus load. They pack up to 16 logic variables inside a single register. This way, a single Modbus/TCP request can be used to read a group of information. Each variable contains the current value of 16 logic variables such as breaker positions, faults, alarms...

They are listed out in the chapter [Software variables \(on page 112\)](#).

The bit fields [956]...[969] have latched values: a reset is required for them to return to 0.



Note: Available data are related only to faults that occurred after the latest power up sequence. Events that occurred before the module has been power cycled are listed in the fault pages but not among the variables.

Example:

The table below shows a Modbus/TCP client sending a reading request (function 04) of 6 registers starting from variable [79].

Client request		Module server response	
Field	Value	Field	Value
Function code	04	Required function.	04
Starting Register (MSB)	00	Data bytes (= 2 * Number of requested registers).	6
Starting Register (LSB)	79	Value of register 0079 (MSB).	D0
Count of registers (MSB)	00	Value of register 0079 (LSB).	D1
Count of registers (LSB)	06	Value of register 0080 (MSB).	D2
		Value of register 0080 (LSB).	D3
		Value of register 0081 (MSB).	D4
		Value of register 0081 (LSB).	D5

CRE-LINK®

Presentation

This CAN bus is used as a communication means between units of a single Power plant to provide the following features:

- Active and reactive load sharing.
- Automatic load/unload ramp.
- Static paralleling.
- Dead bus management.
- Management of segments and Power plant.
- Other data exchange.

Standard CAN bus rules apply here. Refer to [CAN bus good practices \(on page 103\)](#) to connect units properly on CAN bus.

Alarms/faults of the CAN bus

The CAN communication between all **CRE TECHNOLOGY** units is continuously checked by each unit on the CAN bus. The count of units connected to CAN bus must be the same as the count of units declared in each unit. In case of a problem on the bus, alarms or faults can occur:

Missing GENSYS COMPACT PRIME

The **CRE-Link®** protocol cannot see one or several **GENSYS COMPACT PRIME**. The controllers might not be correctly wired on the bus CAN1 or misconfigured.

Missing MASTER COMPACT or BTB COMPACT

The **CRE-Link®** protocol cannot see one or several **MASTER COMPACT/BTB COMPACT/MASTER COMPACT 1B**. The controllers might not be correctly wired on the bus CAN1 or misconfigured.

Missing HYBRID COMPACT

The **CRE-Link®** protocol cannot see one or several **HYBRID COMPACT**. The controllers might not be correctly wired on the bus CAN1 or misconfigured.

Missing BAT COMPACT

The **CRE-Link®** protocol cannot see one or several **BAT COMPACT**. The controllers might not be correctly wired on the bus CAN1 or misconfigured.

Controller communication fault

The communication with the other products is lost. Check that the 120Ω termination resistors are used correctly (see [CAN bus good practices \(on page 103\)](#)). Check that CAN bus cable is properly connected.

CAN1 unknown

An incompatible product is connected on the CAN bus. The module will not start the Generator.

Mismatch vers.

A module with an incompatible version is connected on the CAN bus. The module will share the load using droop control.



Note: Problems can occur if two or more unit have the same Generator number.

For *Missing GENSYS COMPACT PRIME*, *Missing MASTER COMPACT or BTB COMPACT*, *Missing BAT COMPACT*, *Missing HYBRID COMPACT* and *Controller communication fault*, you can configure the behavior to be adopted in case of a CAN fault.

CANOPEN

CANopen extension modules (i.e. CANopen couplers) can be used to increase the number of digital inputs/outputs and analog inputs of the module. Overall max. count of added inputs/outputs: 64 digital inputs, 64 digital outputs and 16 analog inputs. The CANopen protocol inputs/outputs are read/written every 100ms.

Configuration

Setting	Label	Value	Description
[3153]	<i>Coupler ID #1</i>	0 ... 255	Identifier of the first coupler.
[3154]	<i>Number of digital inputs #1</i>	0 ... 64	Number of digital inputs on the first coupler.
[3155]	<i>Number of digital outputs #1</i>	0 ... 64	Number of digital outputs on the first coupler.
[3165]	<i>Number of analog inputs #1</i>	0 ... 16	Number of analog inputs on the first coupler.
[3156]	<i>Coupler ID #2</i>	0 ... 255	Identifier of the second coupler.
[3157]	<i>Number of digital inputs #2</i>	0 ... 64	Number of digital inputs on second coupler.
[3158]	<i>Number of digital outputs #2</i>	0 ... 64	Number of digital outputs on the second coupler.
[3166]	<i>Number of analog inputs #2</i>	0 ... 16	Number of analog inputs on the second coupler.
[3159]	<i>Coupler ID #3</i>	0 ... 255	Identifier of the third coupler.
[3160]	<i>Number of digital inputs #3</i>	0 ... 64	Number of digital inputs on the third coupler.
[3161]	<i>Number of digital outputs #3</i>	0 ... 64	Number of digital outputs on the third coupler.
[3167]	<i>Number of analog inputs #3</i>	0 ... 16	Number of analog inputs on the third coupler.
[3162]	<i>Coupler ID #4</i>	0 ... 255	Identifier of the fourth coupler.
[3163]	<i>Number of digital inputs #4</i>	0 ... 64	Number of digital inputs on the fourth coupler.
[3164]	<i>Number of digital outputs #4</i>	0 ... 64	Number of digital outputs on the fourth coupler.
[3168]	<i>Number of analog inputs #4</i>	0 ... 16	Number of analog inputs on the fourth coupler.



Note: The CANopen couplers ID max range changes according to the number of configured inputs/outputs (for more details, refer to **CiA 301** standard).

The assignment of I/Os is done by order of the couplers declared in the settings (not by id). The lowest variable number is associated to the lowest message number configured.

The digital inputs/outputs of the CANopen protocol have the same attributes as regular inputs/outputs except for the delay at the drop of inputs.

Each CANopen analog input value can be adjusted using a gain and an offset.

Setting	Attribute
Digital inputs 1 ... 64	
[3200] ... [3231], [8550] ... [8581]	Function
[3232] ... [3263], [8582] ... [8613]	Delay
[3264] ... [3295], [8614] ... [8645]	Validity
[3296] ... [3327], [8646] ... [8677]	Polarity
Digital outputs 1 ... 64	
[3350] ... [3381], [8700] ... [8731]	Function
[3382] ... [3413], [8732] ... [8763]	Polarity: <ul style="list-style-type: none"> • 0: Normally de-energized • 1: Normally energized
Analog inputs 1 ... 16	
[8351], [8353], [8355] ... [8381]	Gain
[8350], [8352], [8354] ... [8380]	Offset

An overflow alarm (variable [609]) is available for analog inputs. When it is active, you can look at the variable [610] to know which analog inputs triggered the alarms. If you have several analog inputs causing a problem, you'll have to solve each problem one by one.

On power-up, the configuration of the CANopen extension modules is automatically initialized. The status (variable [3150]) turns to 1.

The CANopen protocol error time-out (variable [3152]) is 10.0s by default.

Variable mapping and inputs/outputs

The CANopen protocol inputs and outputs are accessed by their code:

- Digital inputs: [800]...[831], [1250]...[1281]
- Digital outputs: [4751]...[4782], [5100]...[5131]
- Analog inputs: [1050]...[1065]

MODBUS CLIENT

Overview

A Modbus/TCP client is implemented in the product in order to communicate with an external device that provides Modbus communication.

You may send and retrieve data to and from a unit that is connected through Modbus/TCP or through Modbus RTU if you use a Modbus/TCP to RTU gateway between the devices.

Supported Modbus functions

Different Modbus functions may be used to read/write different kind of data in your remote device as listed below:

Function code 01

Read coils

Function code 02

Read discrete inputs

Function code 03

Read holding registers

Function code 04

Read input registers

Function code 05

Write single coil

Function code 06

Write single register

Setup

Setup is done in page **Controller settings** ⇒ **Programming** ⇒ **Modbus (i4Gen)**. Note that you must be connected to the **COMPACT** unit in order to fully setup the communication parameters, more specifically for the remote Modbus/TCP server IP and communication port.

1. Enable communication to a Modbus/TCP server, input a name for the remote unit and optionally setup an alarm/fault in case of communication timeout. The server name will be used as alarm/fault label in case of a communication incident.

Figure 60. Modbus connection settings menu

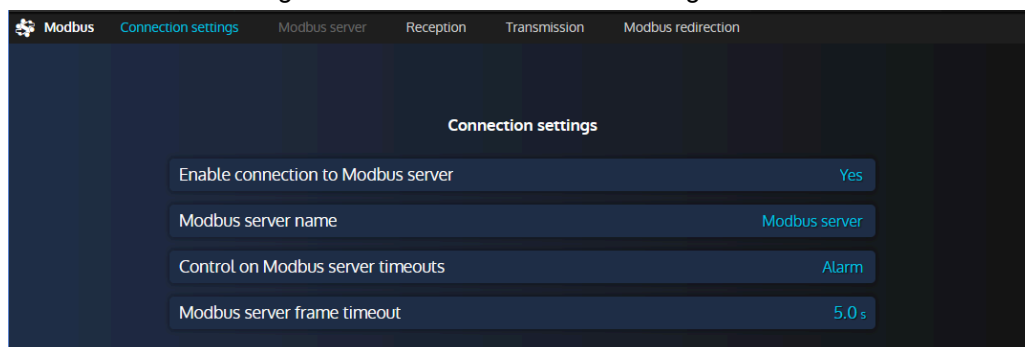

2. Input the server communication parameters (Ethernet IP address and Modbus port). The standard Modbus/TCP protocol port is 502 but this may vary according to your remote device and desired configuration.

Figure 61. Modbus server settings menu

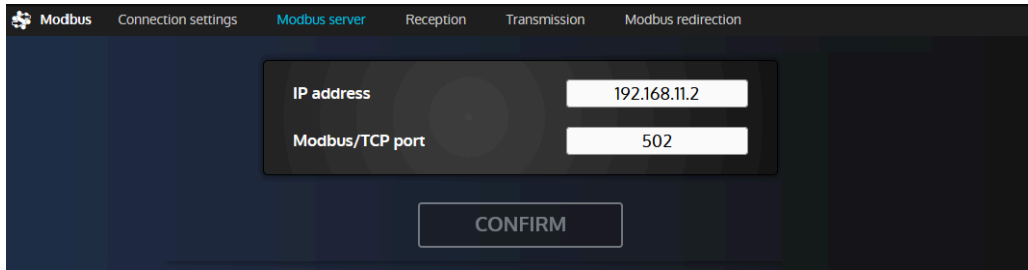

3. You may now switch to the Reception/Transmission pages in order to setup the registers you want to respectively read and write.
 - Reception: a remote register is read and its computed value is written into an internal variable of the **COMPACT** unit.
 - Transmission: an internal variable is computed and sent into a remote register.

You may setup up to 10 reception and 10 transmission lines.

Figure 62. Modbus reception menu

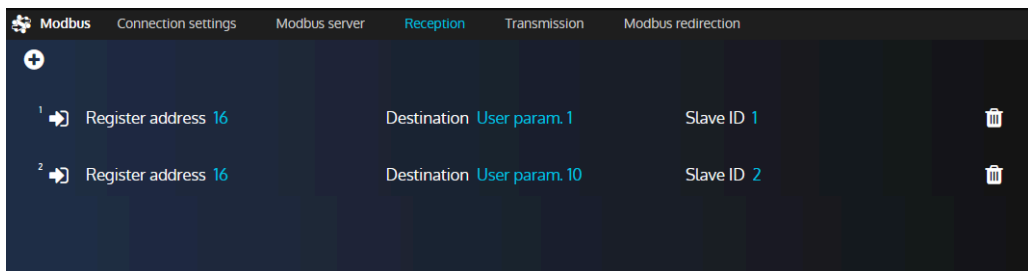

4. Click on the '+' button at the top left corner of the page to add a new reception/transmission line, or click on an existing line in order to modify its setup.

Modbus reception/transmission settings

Figure 63. Modbus transmission menu

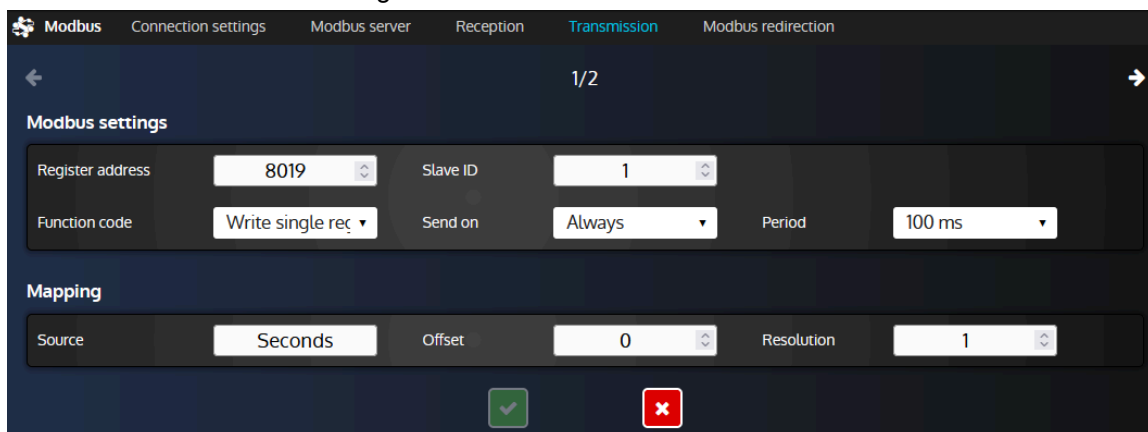

Modbus settings

Function code

Modbus function code used to read/write bits, inputs or registers.

Register address

Address of the Modbus register inside the remote Modbus server. Note that register 1 is located at address 0.

Slave ID

This parameter is typically useful if you need to access a Modbus RTU (RS485) device through a Modbus/TCP to RTU gateway. This way, you can access different Modbus RTU slave devices using a single gateway (server).

Sending condition (transmission lines only)

Always will send a value at the selected period. If **Value change** is selected, register will be written only if the source value has changed. Setting this parameter to **Never** disables the transmission without deleting the whole line: it may be useful for example for testing purposes.

Period (transmission lines only)

Choose the transmission period when the sending parameter is set to **Always**. Different values are proposed in order to let you choose between a light communication traffic or responsiveness.

Mapping settings**Destination (reception lines only)**

Internal variable of the **COMPACT** controller where the result of a computed read register will be written.

Source (transmission lines only)

Internal variable of the **COMPACT** controller that will be used for computation. The result will be sent into the selected remote register in the Modbus server.

Offset and Resolution

These two parameters allow you to set a calculation rule between Modbus registers and **COMPACT** variables as detailed below. For a reception line, destination variable inside the **COMPACT** controller will get the following value: **Result = (Modbus register value) * Resolution + Offset**. For a transmission line, the value sent to the Modbus server will be: **Register value = (Source value) * Resolution + Offset**

**Note: Determining the proper gain when reading values**

It is possible to always use the same formula to determine the gain (as long as the values are linear) for a value you're reading: **gain = value expected / value read via Modbus**.

When reading values, do not forget to set the accuracy (and optionally the unit if there is any, for display purpose only) of the user variable in use via the menu **Controller settings** ⇒ **Programming** ⇒ **User variables (i4Gen)**

Example:

The controller is set to read the register 123 from another Modbus/TCP device and to store it in the variable "Saved var. 1" [8000]. The value is expected to have a precision of 2 digits so we did set the "Saved var. 1" variable with an accuracy of 0.01. The controller reads 5000.00 but the expected value should be 25.00. Assuming that it is a linear value, we simply use the formula as stated before to determine the gain to apply: $25/5000 = 0.005$. Note that if you want to scrap everything after the comma to have the value as an integer number, you can simply change the accuracy of the "Saved var. 1" to 1 (but the gain should remain unchanged).

CAN BUS GOOD PRACTICES

This chapter describes rules to be used to ensure reliable CAN communication. These rules must be applied to all CAN protocol communications, including the **CRE-Link®** protocol and the ECU/remote I/O CAN bus. **CRE TECHNOLOGY** recommends to always use a shielded cable to connect CAN bus.

Cables

⚠ WARNING	
	<p>RISK OF EQUIPMENT DAMAGE Failure to follow this instruction can damage the CAN transmitter/receiver. Switch off the unit before plugging or unplugging the CAN bus connector or disconnecting the wires.</p>

Cables used must be selected to respond to CAN bus specificities. Always use shielded twisted wire pairs. Deploy the CAN bus (no mesh, ring or star topology) as shown below:

Figure 64. CAN bus accepted wiring topologies

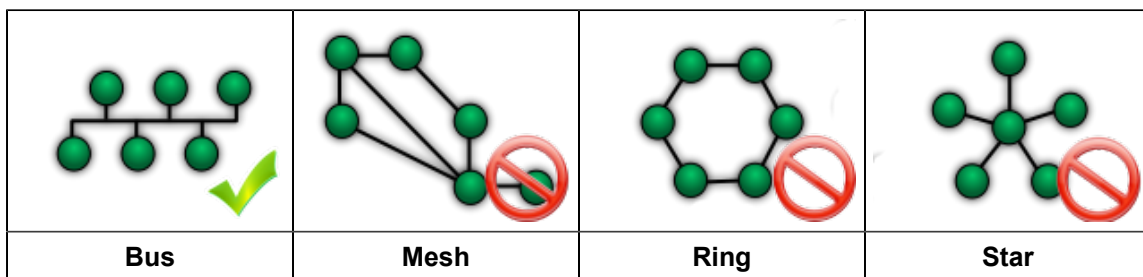

Both ends of the CAN bus must be terminated with a 120Ω resistor. The module has a 120Ω resistor for this purpose. Wiring the terminal RES to CAN H will link CAN L and CAN H with a resistor.

The next figure gives the example of three units connected through a CAN bus. Do NOT install any resistor nor link the terminal RES and CAN H together in the middle unit.

Figure 65. CAN bus wiring example

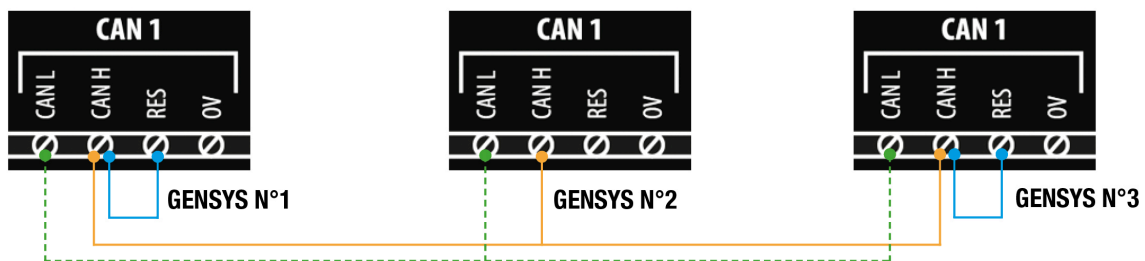
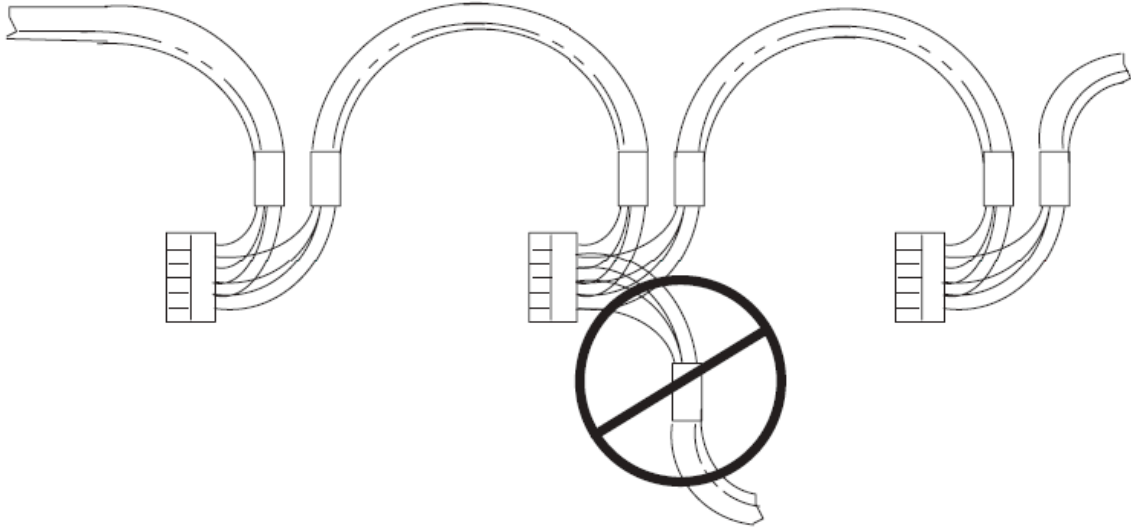

Figure 66. Wrong placement of the termination resistor on the CAN bus



⚠ WARNING



RISK OF EQUIPMENT DAMAGE

Failure to follow this instruction may damage the CAN transmitter/receiver and the controller itself.

Do not, in any cases, connect the "0V" pin to the "-" pin of the power supply.



Note: CRE TECHNOLOGY provides a complete range of products aimed at installing your CAN bus (cords, wires, connectors...). Please contact your local CRE TECHNOLOGY distributor to help you to choose equipment that fits your needs.

Maximum length and bit rate

The maximal length of a CAN bus depends mostly on the communication speed, but also on the quality of wires and connectors used.

The following table shows the maximal length of a CAN bus depending on the bit rate:

Bit rate (kbit/s)	Maximal length (m)
10	5000
20	2500
50	1000
125	500
250	250
500	100
800	50

The next table lists the standard bit rate of each CAN protocol that can be used by a CRE TECHNOLOGY unit:

OPERATOR MANUAL

Bus	Protocol	Bit rate (kbit/s)	Note
CAN1	CRE-Link®	125	125 kbit/s recommended. Can be changed using parameter [3050].
CAN2	CANopen	125 (default)	Can be selected between 125/250/500/1000 kbit/s using parameter [3051] in the Controller settings ⇒ General ⇒ CAN page.

APPENDICES

ENTER A CODE

A code can be used to change a controller type into another (for example, a **GENSYS COMPACT PRIME** can be transformed into a **HYBRID COMPACT**) or to add an option to your controller (i.e. MTU MDEC compatibility). Please contact **CRE TECHNOLOGY** for further information on how to obtain a code.



Note: When entering a code, it is preferable that no other devices than **i4Gen Suite** is connected to the controller.

1. To enter a code, go to the **Controller settings** ⇒ **System** ⇒ **Code (i4Gen)** page.
2. Click the "Confirm" button to send the code to the controller. A success message will show and the controller will restart.

You can now reconnect to the controller:

- If the code entered was to add an option, see the list of active options in the About page.
- If the code entered was to change the controller type, start a firmware update with the appropriated firmware version from the **Controller settings** ⇒ **System** ⇒ **Update (i4Gen)** page.

TROUBLESHOOTING

To get a history of alarms-faults, stop the Generator, connect to **i4Gen** ⇒ **File transfer** and click on the **Save** button beside **History - Alarms/Faults/Events/Logger**.

To restore factory settings from **i4Gen Suite** software, navigate to the **Controller settings** ⇒ **System** ⇒ **Reset factory settings (i4Gen)** page, and click on the **Reset** button.

Alarm/Fault messages

Message "Isolated product"

Check the related connections, including the one of internal resistor (Connect the "RES" terminal and the "CAN H" terminal).

Check the related settings: Quantity of generators, number of each Generator.

Message "Missing product"

Check the other products. One of them is not supplied or disconnected.

Message "Missing master"

Check the **MASTER COMPACT/MASTER COMPACT 1B/BTB COMPACT** products. One of them is not supplied or disconnected.

Message "Missing HYBRID"

Check the **HYBRID COMPACT** products. One of them is not supplied or disconnected.

Message "Missing BAT"

Check the **BAT COMPACT** products. One of them is not supplied or disconnected.

Message "Unknown product"

Check the other products. One of them is not compatible.

Message "Mismatch version"

Check the other products. One of them uses a version which is not compatible.

Message "Breaker" fault

Check the type of breaker against the selection in **Controller settings** ⇒ **Inputs/Outputs** ⇒ **Digital/relays outputs**.

Stop the other generators.

Make sure the digital input set with the function "**Bus breaker feedback**" is connected.

Start the generators in **MAN** mode (or just press ). Make sure the breaker LED turns on (green); otherwise, increase the "breaker feedback" time-out [2304] (default value 5.0s).

Cannot connect with PC

Consider deactivating the firewall and adding an Anti-virus exception.

Check the network wiring, see [Network \(on page 92\)](#)

Error Messages When Transferring a File to the Module



Note: "... " indicate a variable number, a label number or a text number according the error message. It will help you to locate your error in your configuration file.

ERROR 002: Unknown file type

The file type sent is unknown. Check the selected file.

ERROR 004: Write data or checksum error

ERROR 008: Update failed. Please restart update.

Writing memory error during update process. Restart module update.

ERROR 011: No write right on variable

Access to this variable is not allowed. Only parameters can be modified.

ERROR 012: No write right on label

Access to this label is not allowed. Check your configuration file.

ERROR 013: Text doesn't exist.

Access to this text is not possible because it does not exist. Check compatibility of the version/type of the module and the configuration file.

ERROR 014: No write right on Unit

Access to this unit is not allowed. Check your configuration file.

ERROR 015: Need password level 2 to write on Variable

Actual password is not sufficient to access such configuration/control level.

ERROR 017: Configuration not allowing variable value

The actual setting of the module does not allow modifying this parameter with this value. Check your configuration file and the value of the parameter before sending again your configuration file.

ERROR 018: Variable out of range

The value of the parameter is out of range. Check your configuration file before sending again.

ERROR 019: Wrong value for variable

An unexpected value has been detected on this parameter. Check the value of the parameter before sending again.

Ex: a text character has been detected instead of a number.

ERROR 020: Unknown language file

The language file sent does not correspond to a language file for the module. Check the selected language file.

ERROR 021: Too many languages already downloaded

The maximum number of language supported by the module has been reached.

ERROR 022: Wrong language file version

The language file version is above the module version. Update your module to the latest version or get the language file compatible with your module version.

ERROR 023: Label does not exist.

Modifying this label is not allowed. Check the label number before sending the configuration file again.

ERROR 024: Unit does not exist.

Modifying this unit is not allowed. Check the unit number before sending the configuration file again.

ERROR 025: Wrong accuracy value on (0,1,2 or 3)

The value of the accuracy is out of range. The value must be between 0 and 3.

ERROR 026: Wrong unit value on (from 0 to xxx)

The value of the unit is out of range. The value must be between 0 and xxx.

ERROR 027: No header in language file

No header or wrong header of the language file. Check the selected language file before send it again.

ERROR 028: No filename found or too long

No filename or filename is too long. The maximum size of a filename is 40 characters. Rename file and send it again.

ERROR 029: Wrong accuracy on parameter

The value of the modified parameter has not the right accuracy. Check the value of your parameter before sending again your configuration file.

Ex: Below, it is missing the digit at the tenth 5.00

V02205 5.0_ ESG amplitude +000.00 +010.00V

ERROR 030: Data out of range in Easy Flex®

The result of the operation is outside the range value of the output variable.

ERROR 031: Invalid TXT file version

The TXT file is not valid because it comes from a non-compatible firmware.

For example: TXT file from 1.xx version are only compatible with product using 1.xx version. TXT file from 2.xx version are only compatible with product using 2.xx version. Etc...

Warning

Warnings do not prevent the module to work but inform the user of a potential problem in its configuration file.

WARNING 001: Wrong size of label**WARNING 002: Wrong character entered in label****WARNING 003: Wrong size of text****WARNING 004: Wrong character entered in text**

These warnings indicate that the entered labels/texts are too long or that a character is not supported by the module.

Invalid characters will be replaced by "?". The valid characters are the followings:

- 0123456789.-
- ABCDEFGHIJKLMNOPQRSTUVWXYZ

- `!#$()*+/:;=>[]^_?`
- `abcdefghijklmnopqrstuvwxy`

The maximum size of a label is 14 characters and 28 characters for a text.

Modify labels/texts according to the rules above.

WARNING 005: Too many errors...

All errors/warnings messages could not be displayed. There are probably other problems in your configuration file. Solve displayed problems and send your configuration file again in order to display the additional error/warning messages.

WARNING 006: No unit specify on unit

WARNING 007: No value specify on parameter

WARNING 008: No text specify on text

WARNING 009: No label specify on label

These warnings indicate that no value has been filled inside the configuration file for a unit/parameter/text or label. The values will stay unchanged.

WARNING 011: Variable does not exist.

The parameter does not exist. Check compatibility of the version/type of the module and the configuration file.

CERTIFICATIONS

Figure 67. Declaration of conformity



**DECLARATION UE DE CONFORMITE
EU DECLARATION OF CONFORMITY**



Cette Déclaration de Conformité est conforme à la norme européenne EN17050-1 :2004 "Critères généraux pour les déclarations de conformité des fournisseurs". *This Declaration of Conformity is suitable to the European Standard EN 17050-1:2004 "General criteria for supplier's declaration of conformity".*

Nous, **CRE Technology**
We,

Adresse du fabricant : 130, Allée Charles Victor NAUDIN
Manufacturer's Address: Zone des Templiers - Sophia Antipolis
06410 BIOT
FRANCE

déclarons sous notre seule responsabilité, que les produits délivrés:
declare under our sole responsibility that the products as originally delivered:

Nom du produit : MASTER Compact HMI
Product Name: MASTER Compact CORE

Référence produit : A56-MASTER-00-x (HMI)
Regulatory Model: A56-MASTER-10-x (CORE)

Version(s) produit : All
Product Version:

satisfont aux exigences essentielles des Directives Européennes ci-dessous et portent en conséquence le marquage CE :
Comply with the essential requirements of the following applicable European Directives, and carries the CE marking accordingly:

*Low Voltage Directive 2014/35/EU
EMC Directive 2014/30/EU*

CEM/EMC	Standard	Date	Description
	EN61326-1 CISPR11 EN55011 EN55022	2013 2010 + A1 (2011) 2012	EMC general requirements – Industrial environment - class A
	EN61000-4-2	2009	Electrostatic Discharges
	EN61000-4-3	2006 + A2 (2010)	Radiated, RF, electromagnetic field immunity test
	EN61000-4-4	2013	Electrical Fast Transients
	EN61000-4-5	2014	Surge immunity test
	EN61000-4-6	2014	Conducted disturbances immunity
	EN61000-6-2	2006	Generic standards. Immunity for industrial environments
	EN61000-6-4	2010	Generic standards. Emissions for industrial environments
Sécurité/Safety	Standard	Date	Description
	EN60950	2013	Information technology equipment. Safety. General requirements

Cette Déclaration de Conformité s'applique aux produits listés ci-dessus
et placés sur le marché après le:
This DoC applies to above-listed products placed on the market after:

June 28, 2018

SIGNATURE

BIOT – France for CRE technology
Responsable Qualité
Quality Manager

CRE Technology - Allée Charles Victor NAUDIN - Zone des Templiers, Sophia Antipolis - 06410 BIOT - FRANCE
Tél: +33 (0) 4 92 38 86.82 / Fax: +33 (0) 4 92 38 86.83
SARL au Capital de 1000 Euros - RCS Antibes 488 625 583 - TVA : FR 54 488 625 583

Certifications are available for download as PDF files at www.cretechnology.com in the download area.

SOFTWARE VARIABLES



SOFTWARE VARIABLES

CRE TECHNOLOGY
130, allée Charles-Victor Naudin
Zone des Templiers - SOPHIA ANTIPOLIS
06410 BIOT - FRANCE
Phone: + 33 (0)4 .92.38.86.82
www.cretechnology.com
info@cretechnology.com

COPYRIGHT © CRE TECHNOLOGY. ALL RIGHTS RESERVED.

TABLE OF CONTENTS

DYNAMIC	152
Synchronization PID	152
Gain Synch [2904]	152
Proport. Synch [2905]	152
Integral Synch [2906]	153
Derivate Synch [2907]	154
GENERAL	155
Application	155
General	155
My number [2001]	155
Number of GENSYS COMPACT PRIME [2000]	155
Number of MASTER COMPACT/BTB COMPACT [2017]	155
Type of application [2005]	156
Type of regulation [2006]	156
Connection type [2003]	157
Mode	157
Power on mode [2012]	157
Test mode operation [2014]	158
Limited time test mode [2015]	158
Test mode duration [2016]	158
Synchronization & Load Sharing only	159
Synchronization & Load sharing only [2024]	159
Timers	160
Start sequence	160
Stabilization timer on can fault [3469]	160
Delay before activation of the protections [2004]	160
Off load timer (Only for start with timer) [3478]	160
Ramp timer	161
Load ramp timer [2853]	161
Unload ramp timer [2856]	161
Others	161
Horn timer [2478]	161
Mains timers	162
Mains back timer [2009]	162
Change over timer [2007]	162
CAN	163
CAN 1	163
CAN 1 baud rate [3050]	163
Inhibition remote start from CAN [2018]	163
CAN 2	164
CAN 2 baud rate [3051]	164

OPERATOR MANUAL

Segment	164
Segment number [2020]	164
Events	165
Record power up [8300]	165
Record mains status [8302]	165
Record circuit breaker status (Open/Closed) [8303]	165
Record operating mode [8304]	165
Meters	166
Mains kWh [120]	166
Mains kVARh energy [122]	166
ELECTRICAL	167
Bus	167
General	167
Power plant measure [2110]	167
Nominal active power [2111]	167
Nominal reactive power [2112]	167
Nominal voltage [2102]	168
Nominal frequency [2153]	168
PT ratio [2100]	168
CT ratio [2101]	169
Power plant minimum kW [2108]	169
Power plant minimum number of GE [2109]	169
Low kW active power threshold [2866]	170
High kW active power threshold [2867]	170
Control	170
Base load Generator(s) kW setpoint [2107]	170
Power factor setpoint (inductive) [2253]	171
Mains	172
General	172
Mains kW measure type [2155]	172
Nominal voltage [2152]	172
Nominal frequency [2153]	173
PT ratio [2150]	173
CT ratio [2151]	173
External MCB low kW trip [2156]	174
Setpoint	174
Peak shaving kW setpoint [2154]	174
Limit inverter power export [2159]	174
Synchronisation check	175
Voltage acceptance [2800]	175
Frequency acceptance [2801]	175
Phase Angle acceptance [2802]	175

Fail to synchronize timer [2803]	175
Action on fail to synchronize [2804]	176
Phase offset [2812]	176
Power management	177
Load shedding	177
Opening load on under frequency [3702]	177
Under frequency threshold 1 [3700]	177
Under frequency threshold 2 [3701]	177
Opening of the load on maximum kW [3705]	177
Maximum kW threshold 1 [3703]	178
Maximum kW threshold 2 [3704]	178
Timer for threshold 1 [3706]	178
Timer for threshold 2 [3707]	178
Minimum delay between 2 openings [2861]	178
Action after last opening [2862]	179
Unload breakers	179
Enable/disable unload breakers	179
Enable unload breakers [3730]	179
Unload breaker 1	179
Unload breaker kW 1 [3731]	179
Unload breaker timer 1 [3720]	179
Unload breaker 2	180
Unload breaker kW 2 [3732]	180
Unload breaker timer 2 [3721]	180
Unload breaker 3	180
Unload breaker kW 3 [3733]	180
Unload breaker timer 3 [3722]	180
Unload breaker 4	181
Unload breaker kW 4 [3734]	181
Unload breaker timer 4 [3723]	181
Unload breaker 5	181
Unload breaker kW 5 [3735]	181
Unload breaker timer 5 [3724]	181
Unload breaker 6	182
Unload breaker kW 6 [3736]	182
Unload breaker timer 6 [3725]	182
Unload breaker 7	182
Unload breaker kW 7 [3737]	182
Unload breaker timer 7 [3726]	182
Unload breaker 8	183
Unload breaker kW 8 [3738]	183
Unload breaker timer 8 [3727]	183
Unload breaker 9	183

OPERATOR MANUAL

Unload breaker kW 9 [3739]	183
Unload breaker timer 9 [3728]	183
Unload breaker 10	184
Unload breaker kW 10 [3740]	184
Unload breaker timer 10 [3729]	184
INPUTS/OUTPUTS	185
Digital inputs	185
Digital inputs	185
Input 1 (Customisable) [250]	185
Function configured on DI 1 [2700]	185
Polarity NO/NC on DI 1 [2736]	185
Validity on digital input 1 [2727]	185
Timer ON Digital Input 1 [2709]	185
Timer OFF Digital Input 1 [2718]	186
Input 2 (Customisable) [251]	186
Function configured on DI 2 [2701]	186
Polarity NO/NC on DI 2 [2737]	186
Validity on digital input 2 [2728]	186
Timer ON Digital Input 2 [2710]	187
Timer OFF Digital Input 2 [2719]	187
Input 3 (Customisable) [252]	187
Function configured on DI 3 [2702]	187
Polarity NO/NC on DI 3 [2738]	187
Validity on digital input 3 [2729]	188
Timer ON Digital Input 3 [2711]	188
Timer OFF Digital Input 3 [2720]	188
Input 4 (Customisable) [253]	188
Function configured on DI 4 [2703]	188
Polarity NO/NC on DI 4 [2739]	189
Validity on digital input 4 [2730]	189
Timer ON Digital Input 4 [2712]	189
Timer OFF Digital Input 4 [2721]	189
Input 5 (Customisable) [254]	190
Function configured on DI 5 [2704]	190
Polarity NO/NC on DI 5 [2740]	190
Validity on digital input 5 [2731]	190
Timer ON Digital Input 5 [2713]	190
Timer OFF Digital Input 5 [2722]	191
Input 6 (Customisable) [255]	191
Function configured on DI 6 [2705]	191
Polarity NO/NC on DI 6 [2741]	191
Validity on digital input 6 [2732]	191

Timer ON Digital Input 6 [2714]	192
Timer OFF Digital Input 6 [2723]	192
Input 7 (Customisable) [256]	192
Function configured on DI 7 [2706]	192
Polarity NO/NC on DI 7 [2742]	192
Validity on digital input 7 [2733]	193
Timer ON Digital Input 7 [2715]	193
Timer OFF Digital Input 7 [2724]	193
Input 8 (Customisable) [257]	193
Function configured on DI 8 [2707]	193
Polarity NO/NC on DI 8 [2743]	194
Validity on digital input 8 [2734]	194
Timer ON Digital Input 8 [2716]	194
Timer OFF Digital Input 8 [2725]	194
Input 9 (Customisable) [258]	195
Function configured on DI 9 [2708]	195
Polarity NO/NC on DI 9 [2744]	195
Validity on digital input 9 [2735]	195
Timer ON Digital Input 9 [2717]	195
Timer OFF Digital Input 9 [2726]	196
Hysteresis on digital input	196
Hysteresis on digital input 1	196
Hysteresis 1 enable for digital input [2769]	196
Timer ON hysteresis 1 [2777]	196
Direction hysteresis 1 [2785]	197
Hysteresis on digital input 2	197
Hysteresis 2 enable for digital input [2770]	197
Timer ON hysteresis 2 [2778]	197
Direction hysteresis 2 [2786]	198
Hysteresis on digital input 3	198
Hysteresis 3 enable for digital input [2771]	198
Timer ON hysteresis 3 [2779]	198
Direction hysteresis 3 [2787]	199
Hysteresis on digital input 4	199
Hysteresis 4 enable for digital input [2772]	199
Timer ON hysteresis 4 [2780]	199
Direction hysteresis 4 [2788]	200
Hysteresis on digital input 5	200
Hysteresis 5 enable for digital input [2773]	200
Timer ON hysteresis 5 [2781]	200
Direction hysteresis 5 [2789]	201
Hysteresis on digital input 6	201
Hysteresis 6 enable for digital input [2774]	201

Timer ON hysteresis 6 [2782]	201
Direction hysteresis 6 [2790]	202
Hysteresis on digital input 7	202
Hysteresis 7 enable for digital input [2775]	202
Timer ON hysteresis 7 [2783]	202
Direction hysteresis 7 [2791]	203
Hysteresis on digital input 8	203
Hysteresis 8 enable for digital input [2776]	203
Timer ON hysteresis 8 [2784]	203
Direction hysteresis 8 [2792]	204
Digital/relays outputs	205
Digital outputs	205
Output 1 (Customisable) [4350]	205
Function configured DO 1 [2745]	205
Polarity NE/ND DO 1 [2751]	205
Pulse length DO 1 [2761]	205
Activation delay DO 01 [2793]	205
Output 2 (Customisable) [4351]	206
Function configured DO 2 [2746]	206
Polarity NE/ND DO 2 [2752]	206
Pulse length DO 2 [2762]	206
Activation delay DO 02 [2794]	206
Output 3 (Customisable) [4352]	207
Function configured DO 3 [2747]	207
Polarity NE/ND DO 3 [2753]	207
Pulse length DO 3 [2763]	207
Activation delay DO 03 [2795]	207
Output 4 (Customisable) [4353]	208
Function configured DO 4 [2748]	208
Polarity NE/ND DO 4 [2754]	208
Pulse length DO 4 [2764]	208
Activation delay DO 04 [2796]	208
Output 5 (Customisable) [4354]	209
Function configured DO 5 [2749]	209
Polarity NE/ND DO 5 [2755]	209
Pulse length DO 5 [2765]	209
Activation delay DO 05 [2797]	209
Output 6 (Customisable) [4355]	210
Function configured DO 6 [2750]	210
Polarity NE/ND DO 6 [2756]	210
Pulse length DO 6 [2766]	210
Activation delay DO 06 [2798]	210
Relay outputs	211

Relay 1 (Customisable) [4356]	211
Output function Relay 1 [2757]	211
Direction NO/NC Relay 1 [2759]	211
Pulse length R 1 [2767]	211
Activation delay relay 1 [8250]	211
Relay 2 (Customisable) [4357]	212
Output function Relay 2 [2758]	212
Direction NO/NC Relay 2 [2760]	212
Pulse length R 2 [2768]	212
Activation delay relay 2 [8251]	212
Breaker	213
General	213
Synchronization back timer [2806]	213
Fail to open/close breaker timer [2304]	213
Unexpected close/open breaker timer [2317]	213
Bus breaker	214
Attempts number	214
Synchronization Back attempts number [2807]	214
Control	214
Bus circuit breaker control type [2300]	214
Pulse	214
Bus breaker control pulse length [2301]	214
Undervoltage coil deenergized time [2302]	215
Undervoltage coil security timer [2303]	215
Mains breaker	215
Attempts number	215
Synchronization Back attempts number [2814]	215
Control	216
Mains circuit breaker control type [2307]	216
Pulse	216
Mains breaker control pulse length [2314]	216
Undervoltage coil deenergized time [2315]	216
Undervoltage coil security timer [2316]	216
Mains failure	217
Mains breaker tripping mode on mains failure [2312]	217
Timer to open mains breaker on mains failure [2313]	217
CANopen	218
Digital inputs	218
CANopen DI 1 (Customisable) [800]	218
CANopenFuncI1 [3200]	218
CANopenDir I1 [3296]	218
Validity on CANopen digital input 1 [3264]	218
CANopenTM I1 [3232]	218

CANopen DI 2 (Customisable) [801]	219
CANopenFuncI2 [3201]	219
CANopenDir I2 [3297]	219
Validity on CANopen digital input 2 [3265]	219
CANopenTM I2 [3233]	219
CANopen DI 3 (Customisable) [802]	220
CANopenFuncI3 [3202]	220
CANopenDir I3 [3298]	220
Validity on CANopen digital input 3 [3266]	220
CANopenTM I3 [3234]	220
CANopen DI 4 (Customisable) [803]	221
CANopenFuncI4 [3203]	221
CANopenDir I4 [3299]	221
Validity on CANopen digital input 4 [3267]	221
CANopenTM I4 [3235]	221
CANopen DI 5 (Customisable) [804]	222
CANopenFuncI5 [3204]	222
CANopenDir I5 [3300]	222
Validity on CANopen digital input 5 [3268]	222
CANopenTM I5 [3236]	222
CANopen DI 6 (Customisable) [805]	223
CANopenFuncI6 [3205]	223
CANopenDir I6 [3301]	223
Validity on CANopen digital input 6 [3269]	223
CANopenTM I6 [3237]	223
CANopen DI 7 (Customisable) [806]	224
CANopenFuncI7 [3206]	224
CANopenDir I7 [3302]	224
Validity on CANopen digital input 7 [3270]	224
CANopenTM I7 [3238]	224
CANopen DI 8 (Customisable) [807]	225
CANopenFuncI8 [3207]	225
CANopenDir I8 [3303]	225
Validity on CANopen digital input 8 [3271]	225
CANopenTM I8 [3239]	225
CANopen DI 9 (Customisable) [808]	226
CANopenFuncI9 [3208]	226
CANopenDir I9 [3304]	226
Validity on CANopen digital input 9 [3272]	226
CANopenTM I9 [3240]	226
CANopen DI 10 (Customisable) [809]	227
CANopenFuncI10 [3209]	227
CANopenDir I10 [3305]	227

Validity on CANopen digital input 10 [3273]	227
CANopenTM I10 [3241]	227
CANopen DI 11 (Customisable) [810]	228
CANopenFuncI11 [3210]	228
CANopenDir I11 [3306]	228
Validity on CANopen digital input 11 [3274]	228
CANopenTM I11 [3242]	228
CANopen DI 12 (Customisable) [811]	229
CANopenFuncI12 [3211]	229
CANopenDir I12 [3307]	229
Validity on CANopen digital input 12 [3275]	229
CANopenTM I12 [3243]	229
CANopen DI 13 (Customisable) [812]	230
CANopenFuncI13 [3212]	230
CANopenDir I13 [3308]	230
Validity on CANopen digital input 13 [3276]	230
CANopenTM I13 [3244]	230
CANopen DI 14 (Customisable) [813]	231
CANopenFuncI14 [3213]	231
CANopenDir I14 [3309]	231
Validity on CANopen digital input 14 [3277]	231
CANopenTM I14 [3245]	231
CANopen DI 15 (Customisable) [814]	232
CANopenFuncI15 [3214]	232
CANopenDir I15 [3310]	232
Validity on CANopen digital input 15 [3278]	232
CANopenTM I15 [3246]	232
CANopen DI 16 (Customisable) [815]	233
CANopenFuncI16 [3215]	233
CANopenDir I16 [3311]	233
Validity on CANopen digital input 16 [3279]	233
CANopenTM I16 [3247]	233
CANopen DI 17 (Customisable) [816]	234
CANopenFuncI17 [3216]	234
CANopenDir I17 [3312]	234
Validity on CANopen digital input 17 [3280]	234
CANopenTM I17 [3248]	234
CANopen DI 18 (Customisable) [817]	235
CANopenFuncI18 [3217]	235
CANopenDir I18 [3313]	235
Validity on CANopen digital input 18 [3281]	235
CANopenTM I18 [3249]	235
CANopen DI 19 (Customisable) [818]	236

CANopenFuncI19 [3218]	236
CANopenDir I19 [3314]	236
Validity on CANopen digital input 19 [3282]	236
CANopenTM I19 [3250]	236
CANopen DI 20 (Customisable) [819]	237
CANopenFuncI20 [3219]	237
CANopenDir I20 [3315]	237
Validity on CANopen digital input 20 [3283]	237
CANopenTM I20 [3251]	237
CANopen DI 21 (Customisable) [820]	238
CANopenFuncI21 [3220]	238
CANopenDir I21 [3316]	238
Validity on CANopen digital input 21 [3284]	238
CANopenTM I21 [3252]	238
CANopen DI 22 (Customisable) [821]	239
CANopenFuncI22 [3221]	239
CANopenDir I22 [3317]	239
Validity on CANopen digital input 22 [3285]	239
CANopenTM I22 [3253]	239
CANopen DI 23 (Customisable) [822]	240
CANopenFuncI23 [3222]	240
CANopenDir I23 [3318]	240
Validity on CANopen digital input 23 [3286]	240
CANopenTM I23 [3254]	240
CANopen DI 24 (Customisable) [823]	241
CANopenFuncI24 [3223]	241
CANopenDir I24 [3319]	241
Validity on CANopen digital input 24 [3287]	241
CANopenTM I24 [3255]	241
CANopen DI 25 (Customisable) [824]	242
CANopenFuncI25 [3224]	242
CANopenDir I25 [3320]	242
Validity on CANopen digital input 25 [3288]	242
CANopenTM I25 [3256]	242
CANopen DI 26 (Customisable) [825]	243
CANopenFuncI26 [3225]	243
CANopenDir I26 [3321]	243
Validity on CANopen digital input 26 [3289]	243
CANopenTM I26 [3257]	243
CANopen DI 27 (Customisable) [826]	244
CANopenFuncI27 [3226]	244
CANopenDir I27 [3322]	244
Validity on CANopen digital input 27 [3290]	244

CANopenTM I27 [3258]	244
CANopen DI 28 (Customisable) [827]	245
CANopenFuncI28 [3227]	245
CANopenDir I28 [3323]	245
Validity on CANopen digital input 28 [3291]	245
CANopenTM I28 [3259]	245
CANopen DI 29 (Customisable) [828]	246
CANopenFuncI29 [3228]	246
CANopenDir I29 [3324]	246
Validity on CANopen digital input 29 [3292]	246
CANopenTM I29 [3260]	246
CANopen DI 30 (Customisable) [829]	247
CANopenFuncI30 [3229]	247
CANopenDir I30 [3325]	247
Validity on CANopen digital input 30 [3293]	247
CANopenTM I30 [3261]	247
CANopen DI 31 (Customisable) [830]	248
CANopenFuncI31 [3230]	248
CANopenDir I31 [3326]	248
Validity on CANopen digital input 31 [3294]	248
CANopenTM I31 [3262]	248
CANopen DI 32 (Customisable) [831]	249
CANopenFuncI32 [3231]	249
CANopenDir I32 [3327]	249
Validity on CANopen digital input 32 [3295]	249
CANopenTM I32 [3263]	249
CANopen DI 33 (Customisable) [1250]	250
CANopenFuncI33 [8550]	250
CANopenDir I33 [8646]	250
Validity on CANopen digital input 33 [8614]	250
CANopenTM I33 [8582]	250
CANopen DI 34 (Customisable) [1251]	251
CANopenFuncI34 [8551]	251
CANopenDir I34 [8647]	251
Validity on CANopen digital input 34 [8615]	251
CANopenTM I34 [8583]	251
CANopen DI 35 (Customisable) [1252]	252
CANopenFuncI35 [8552]	252
CANopenDir I35 [8648]	252
Validity on CANopen digital input 35 [8616]	252
CANopenTM I35 [8584]	252
CANopen DI 36 (Customisable) [1253]	253
CANopenFuncI36 [8553]	253

CANopenDir I36 [8649]	253
Validity on CANopen digital input 36 [8617]	253
CANopenTM I36 [8585]	253
CANopen DI 37 (Customisable) [1254]	254
CANopenFuncI37 [8554]	254
CANopenDir I37 [8650]	254
Validity on CANopen digital input 37 [8618]	254
CANopenTM I37 [8586]	254
CANopen DI 38 (Customisable) [1255]	255
CANopenFuncI38 [8555]	255
CANopenDir I38 [8651]	255
Validity on CANopen digital input 38 [8619]	255
CANopenTM I38 [8587]	255
CANopen DI 39 (Customisable) [1256]	256
CANopenFuncI39 [8556]	256
CANopenDir I39 [8652]	256
Validity on CANopen digital input 39 [8620]	256
CANopenTM I39 [8588]	256
CANopen DI 40 (Customisable) [1257]	257
CANopenFuncI40 [8557]	257
CANopenDir I40 [8653]	257
Validity on CANopen digital input 40 [8621]	257
CANopenTM I40 [8589]	257
CANopen DI 41 (Customisable) [1258]	258
CANopenFuncI41 [8558]	258
CANopenDir I41 [8654]	258
Validity on CANopen digital input 41 [8622]	258
CANopenTM I41 [8590]	258
CANopen DI 42 (Customisable) [1259]	259
CANopenFuncI42 [8559]	259
CANopenDir I42 [8655]	259
Validity on CANopen digital input 42 [8623]	259
CANopenTM I42 [8591]	259
CANopen DI 43 (Customisable) [1260]	260
CANopenFuncI43 [8560]	260
CANopenDir I43 [8656]	260
Validity on CANopen digital input 43 [8624]	260
CANopenTM I43 [8592]	260
CANopen DI 44 (Customisable) [1261]	261
CANopenFuncI44 [8561]	261
CANopenDir I44 [8657]	261
Validity on CANopen digital input 44 [8625]	261
CANopenTM I44 [8593]	261

CANopen DI 45 (Customisable) [1262]	262
CANopenFuncI45 [8562]	262
CANopenDir I45 [8658]	262
Validity on CANopen digital input 45 [8626]	262
CANopenTM I45 [8594]	262
CANopen DI 46 (Customisable) [1263]	263
CANopenFuncI46 [8563]	263
CANopenDir I46 [8659]	263
Validity on CANopen digital input 46 [8627]	263
CANopenTM I46 [8595]	263
CANopen DI 47 (Customisable) [1264]	264
CANopenFuncI47 [8564]	264
CANopenDir I47 [8660]	264
Validity on CANopen digital input 47 [8628]	264
CANopenTM I47 [8596]	264
CANopen DI 48 (Customisable) [1265]	265
CANopenFuncI48 [8565]	265
CANopenDir I48 [8661]	265
Validity on CANopen digital input 48 [8629]	265
CANopenTM I48 [8597]	265
CANopen DI 49 (Customisable) [1266]	266
CANopenFuncI49 [8566]	266
CANopenDir I49 [8662]	266
Validity on CANopen digital input 49 [8630]	266
CANopenTM I49 [8598]	266
CANopen DI 50 (Customisable) [1267]	267
CANopenFuncI50 [8567]	267
CANopenDir I50 [8663]	267
Validity on CANopen digital input 50 [8631]	267
CANopenTM I50 [8599]	267
CANopen DI 51 (Customisable) [1268]	268
CANopenFuncI51 [8568]	268
CANopenDir I51 [8664]	268
Validity on CANopen digital input 51 [8632]	268
CANopenTM I51 [8600]	268
CANopen DI 52 (Customisable) [1269]	269
CANopenFuncI52 [8569]	269
CANopenDir I52 [8665]	269
Validity on CANopen digital input 52 [8633]	269
CANopenTM I52 [8601]	269
CANopen DI 53 (Customisable) [1270]	270
CANopenFuncI53 [8570]	270
CANopenDir I53 [8666]	270

Validity on CANopen digital input 53 [8634]	270
CANopenTM I53 [8602]	270
CANopen DI 54 (Customisable) [1271]	271
CANopenFuncI54 [8571]	271
CANopenDir I54 [8667]	271
Validity on CANopen digital input 54 [8635]	271
CANopenTM I54 [8603]	271
CANopen DI 55 (Customisable) [1272]	272
CANopenFuncI55 [8572]	272
CANopenDir I55 [8668]	272
Validity on CANopen digital input 55 [8636]	272
CANopenTM I55 [8604]	272
CANopen DI 56 (Customisable) [1273]	273
CANopenFuncI56 [8573]	273
CANopenDir I56 [8669]	273
Validity on CANopen digital input 56 [8637]	273
CANopenTM I56 [8605]	273
CANopen DI 57 (Customisable) [1274]	274
CANopenFuncI57 [8574]	274
CANopenDir I57 [8670]	274
Validity on CANopen digital input 57 [8638]	274
CANopenTM I57 [8606]	274
CANopen DI 58 (Customisable) [1275]	275
CANopenFuncI58 [8575]	275
CANopenDir I58 [8671]	275
Validity on CANopen digital input 58 [8639]	275
CANopenTM I58 [8607]	275
CANopen DI 59 (Customisable) [1276]	276
CANopenFuncI59 [8576]	276
CANopenDir I59 [8672]	276
Validity on CANopen digital input 59 [8640]	276
CANopenTM I59 [8608]	276
CANopen DI 60 (Customisable) [1277]	277
CANopenFuncI60 [8577]	277
CANopenDir I60 [8673]	277
Validity on CANopen digital input 60 [8641]	277
CANopenTM I60 [8609]	277
CANopen DI 61 (Customisable) [1278]	278
CANopenFuncI61 [8578]	278
CANopenDir I61 [8674]	278
Validity on CANopen digital input 61 [8642]	278
CANopenTM I61 [8610]	278
CANopen DI 62 (Customisable) [1279]	279

CANopenFuncI62 [8579]	279
CANopenDir I62 [8675]	279
Validity on CANopen digital input 62 [8643]	279
CANopenTM I62 [8611]	279
CANopen DI 63 (Customisable) [1280]	280
CANopenFuncI63 [8580]	280
CANopenDir I63 [8676]	280
Validity on CANopen digital input 63 [8644]	280
CANopenTM I63 [8612]	280
CANopen DI 64 (Customisable) [1281]	281
CANopenFuncI64 [8581]	281
CANopenDir I64 [8677]	281
Validity on CANopen digital input 64 [8645]	281
CANopenTM I64 [8613]	281
Digital outputs	282
CANopen DO 1 (Customisable) [4751]	282
CANopenFuncO1 [3350]	282
CANopenModeO1 [3382]	282
CANopen DO 2 (Customisable) [4752]	282
CANopenFuncO2 [3351]	282
CANopenModeO2 [3383]	282
CANopen DO 3 (Customisable) [4753]	283
CANopenFuncO3 [3352]	283
CANopenModeO3 [3384]	283
CANopen DO 4 (Customisable) [4754]	283
CANopenFuncO4 [3353]	283
CANopenModeO4 [3385]	283
CANopen DO 5 (Customisable) [4755]	284
CANopenFuncO5 [3354]	284
CANopenModeO5 [3386]	284
CANopen DO 6 (Customisable) [4756]	284
CANopenFuncO6 [3355]	284
CANopenModeO6 [3387]	284
CANopen DO 7 (Customisable) [4757]	285
CANopenFuncO7 [3356]	285
CANopenModeO7 [3388]	285
CANopen DO 8 (Customisable) [4758]	285
CANopenFuncO8 [3357]	285
CANopenModeO8 [3389]	285
CANopen DO 9 (Customisable) [4759]	286
CANopenFuncO9 [3358]	286
CANopenModeO9 [3390]	286
CANopen DO 10 (Customisable) [4760]	286

CANopenFuncO10 [3359]	286
CANopenModeO10 [3391]	286
CANopen DO 11 (Customisable) [4761]	287
CANopenFuncO11 [3360]	287
CANopenModeO11 [3392]	287
CANopen DO 12 (Customisable) [4762]	287
CANopenFuncO12 [3361]	287
CANopenModeO12 [3393]	287
CANopen DO 13 (Customisable) [4763]	288
CANopenFuncO13 [3362]	288
CANopenModeO13 [3394]	288
CANopen DO 14 (Customisable) [4764]	288
CANopenFuncO14 [3363]	288
CANopenModeO14 [3395]	288
CANopen DO 15 (Customisable) [4765]	289
CANopenFuncO15 [3364]	289
CANopenModeO15 [3396]	289
CANopen DO 16 (Customisable) [4766]	289
CANopenFuncO16 [3365]	289
CANopenModeO16 [3397]	289
CANopen DO 17 (Customisable) [4767]	290
CANopenFuncO17 [3366]	290
CANopenModeO17 [3398]	290
CANopen DO 18 (Customisable) [4768]	290
CANopenFuncO18 [3367]	290
CANopenModeO18 [3399]	290
CANopen DO 19 (Customisable) [4769]	291
CANopenFuncO19 [3368]	291
CANopenModeO19 [3400]	291
CANopen DO 20 (Customisable) [4770]	291
CANopenFuncO20 [3369]	291
CANopenModeO20 [3401]	291
CANopen DO 21 (Customisable) [4771]	292
CANopenFuncO21 [3370]	292
CANopenModeO21 [3402]	292
CANopen DO 22 (Customisable) [4772]	292
CANopenFuncO22 [3371]	292
CANopenModeO22 [3403]	292
CANopen DO 23 (Customisable) [4773]	293
CANopenFuncO23 [3372]	293
CANopenModeO23 [3404]	293
CANopen DO 24 (Customisable) [4774]	293
CANopenFuncO24 [3373]	293

CANopenModeO24 [3405]	293
CANopen DO 25 (Customisable) [4775]	294
CANopenFuncO25 [3374]	294
CANopenModeO25 [3406]	294
CANopen DO 26 (Customisable) [4776]	294
CANopenFuncO26 [3375]	294
CANopenModeO26 [3407]	294
CANopen DO 27 (Customisable) [4777]	295
CANopenFuncO27 [3376]	295
CANopenModeO27 [3408]	295
CANopen DO 28 (Customisable) [4778]	295
CANopenFuncO28 [3377]	295
CANopenModeO28 [3409]	295
CANopen DO 29 (Customisable) [4779]	296
CANopenFuncO29 [3378]	296
CANopenModeO29 [3410]	296
CANopen DO 30 (Customisable) [4780]	296
CANopenFuncO30 [3379]	296
CANopenModeO30 [3411]	296
CANopen DO 31 (Customisable) [4781]	297
CANopenFuncO31 [3380]	297
CANopenModeO31 [3412]	297
CANopen DO 32 (Customisable) [4782]	297
CANopenFuncO32 [3381]	297
CANopenModeO32 [3413]	297
CANopen DO 33 (Customisable) [5100]	298
CANopenFuncO33 [8700]	298
CANopenModeO33 [8732]	298
CANopen DO 34 (Customisable) [5101]	298
CANopenFuncO34 [8701]	298
CANopenModeO34 [8733]	298
CANopen DO 35 (Customisable) [5102]	299
CANopenFuncO35 [8702]	299
CANopenModeO35 [8734]	299
CANopen DO 36 (Customisable) [5103]	299
CANopenFuncO36 [8703]	299
CANopenModeO36 [8735]	299
CANopen DO 37 (Customisable) [5104]	300
CANopenFuncO37 [8704]	300
CANopenModeO37 [8736]	300
CANopen DO 38 (Customisable) [5105]	300
CANopenFuncO38 [8705]	300
CANopenModeO38 [8737]	300

CANopen DO 39 (Customisable) [5106]	301
CANopenFuncO39 [8706]	301
CANopenModeO39 [8738]	301
CANopen DO 40 (Customisable) [5107]	301
CANopenFuncO40 [8707]	301
CANopenModeO40 [8739]	301
CANopen DO 41 (Customisable) [5108]	302
CANopenFuncO41 [8708]	302
CANopenModeO41 [8740]	302
CANopen DO 42 (Customisable) [5109]	302
CANopenFuncO42 [8709]	302
CANopenModeO42 [8741]	302
CANopen DO 43 (Customisable) [5110]	303
CANopenFuncO43 [8710]	303
CANopenModeO43 [8742]	303
CANopen DO 44 (Customisable) [5111]	303
CANopenFuncO44 [8711]	303
CANopenModeO44 [8743]	303
CANopen DO 45 (Customisable) [5112]	304
CANopenFuncO45 [8712]	304
CANopenModeO45 [8744]	304
CANopen DO 46 (Customisable) [5113]	304
CANopenFuncO46 [8713]	304
CANopenModeO46 [8745]	304
CANopen DO 47 (Customisable) [5114]	305
CANopenFuncO47 [8714]	305
CANopenModeO47 [8746]	305
CANopen DO 48 (Customisable) [5115]	305
CANopenFuncO48 [8715]	305
CANopenModeO48 [8747]	305
CANopen DO 49 (Customisable) [5116]	306
CANopenFuncO49 [8716]	306
CANopenModeO49 [8748]	306
CANopen DO 50 (Customisable) [5117]	306
CANopenFuncO50 [8717]	306
CANopenModeO50 [8749]	306
CANopen DO 51 (Customisable) [5118]	307
CANopenFuncO51 [8718]	307
CANopenModeO51 [8750]	307
CANopen DO 52 (Customisable) [5119]	307
CANopenFuncO52 [8719]	307
CANopenModeO52 [8751]	307
CANopen DO 53 (Customisable) [5120]	308

CANopenFunc053 [8720]	308
CANopenMode053 [8752]	308
CANopen DO 54 (Customisable) [5121]	308
CANopenFunc054 [8721]	308
CANopenMode054 [8753]	308
CANopen DO 55 (Customisable) [5122]	309
CANopenFunc055 [8722]	309
CANopenMode055 [8754]	309
CANopen DO 56 (Customisable) [5123]	309
CANopenFunc056 [8723]	309
CANopenMode056 [8755]	309
CANopen DO 57 (Customisable) [5124]	310
CANopenFunc057 [8724]	310
CANopenMode057 [8756]	310
CANopen DO 58 (Customisable) [5125]	310
CANopenFunc058 [8725]	310
CANopenMode058 [8757]	310
CANopen DO 59 (Customisable) [5126]	311
CANopenFunc059 [8726]	311
CANopenMode059 [8758]	311
CANopen DO 60 (Customisable) [5127]	311
CANopenFunc060 [8727]	311
CANopenMode060 [8759]	311
CANopen DO 61 (Customisable) [5128]	312
CANopenFunc061 [8728]	312
CANopenMode061 [8760]	312
CANopen DO 62 (Customisable) [5129]	312
CANopenFunc062 [8729]	312
CANopenMode062 [8761]	312
CANopen DO 63 (Customisable) [5130]	313
CANopenFunc063 [8730]	313
CANopenMode063 [8762]	313
CANopen DO 64 (Customisable) [5131]	313
CANopenFunc064 [8731]	313
CANopenMode064 [8763]	313
Analog inputs	314
 Analog inputs 1	314
CANopen AI 1 (Customisable) [1050]	314
CANopen Gain AI 01 [8351]	314
CANopen Offset AI 01 [8350]	314
 Analog inputs 2	314
CANopen AI 2 (Customisable) [1051]	314
CANopen Gain AI 02 [8353]	315

CANopen Offset AI 02 [8352]	315
Analog inputs 3	315
CANopen AI 3 (Customisable) [1052]	315
CANopen Gain AI 03 [8355]	315
CANopen Offset AI 03 [8354]	315
Analog inputs 4	316
CANopen AI 4 (Customisable) [1053]	316
CANopen Gain AI 04 [8357]	316
CANopen Offset AI 04 [8356]	316
Analog inputs 5	316
CANopen AI 5 (Customisable) [1054]	316
CANopen Gain AI 05 [8359]	317
CANopen Offset AI 05 [8358]	317
Analog inputs 6	317
CANopen AI 6 (Customisable) [1055]	317
CANopen Gain AI 06 [8361]	317
CANopen Offset AI 06 [8360]	317
Analog inputs 7	318
CANopen AI 7 (Customisable) [1056]	318
CANopen Gain AI 07 [8363]	318
CANopen Offset AI 07 [8362]	318
Analog inputs 8	318
CANopen AI 8 (Customisable) [1057]	318
CANopen Gain AI 08 [8365]	319
CANopen Offset AI 08 [8364]	319
Analog inputs 9	319
CANopen AI 9 (Customisable) [1058]	319
CANopen Gain AI 09 [8367]	319
CANopen Offset AI 09 [8366]	319
Analog inputs 10	320
CANopen AI 10 (Customisable) [1059]	320
CANopen Gain AI 10 [8369]	320
CANopen Offset AI 10 [8368]	320
Analog inputs 11	320
CANopen AI 11 (Customisable) [1060]	320
CANopen Gain AI 11 [8371]	321
CANopen Offset AI 11 [8370]	321
Analog inputs 12	321
CANopen AI 12 (Customisable) [1061]	321
CANopen Gain AI 12 [8373]	321
CANopen Offset AI 12 [8372]	321
Analog inputs 13	322
CANopen AI 13 (Customisable) [1062]	322

CANopen Gain AI 13 [8375]	322
CANopen Offset AI 13 [8374]	322
Analog inputs 14	322
CANopen AI 14 (Customisable) [1063]	322
CANopen Gain AI 14 [8377]	323
CANopen Offset AI 14 [8376]	323
Analog inputs 15	323
CANopen AI 15 (Customisable) [1064]	323
CANopen Gain AI 15 [8379]	323
CANopen Offset AI 15 [8378]	323
Analog inputs 16	324
CANopen AI 16 (Customisable) [1065]	324
CANopen Gain AI 16 [8381]	324
CANopen Offset AI 16 [8380]	324
PROTECTIONS	325
Bus protections	325
Over/under frequency	325
Over frequency	325
Over frequency threshold [2400]	325
Over frequency timer [2401]	325
Over frequency control [2402]	325
Under frequency	326
Under frequency threshold [2403]	326
Under frequency timer [2404]	326
Under frequency control [2405]	326
Over frequency 2	326
Over frequency threshold 2 [2436]	326
Over frequency timer 2 [2437]	327
Over frequency control 2 [2438]	327
Under frequency 2	327
Under frequency threshold 2 [2439]	327
Under frequency timer 2 [2440]	327
Under frequency control 2 [2441]	328
Over/under voltage	328
Over voltage	328
Over voltage threshold [2406]	328
Over voltage timer [2407]	328
Over voltage control [2408]	328
Under voltage	329
Under voltage threshold [2409]	329
Under voltage timer [2410]	329
Under voltage control [2411]	329

Over voltage 2	329
Over voltage threshold 2 [2442]	329
Over voltage timer 2 [2443]	330
Over voltage control 2 [2444]	330
Under voltage 2	330
Under voltage threshold 2 [2445]	330
Under voltage timer 2 [2446]	330
Under voltage control 2 [2447]	331
Voltage unbalance	331
Voltage unbalance	331
Voltage unbalance threshold [2486]	331
Voltage unbalance timer [2487]	331
Voltage unbalance control [2488]	331
Voltage unbalance 2	332
Voltage unbalance threshold 2 [2489]	332
Voltage unbalance timer 2 [2490]	332
Voltage unbalance control 2 [2491]	332
Rotophase	332
Rotophase protection control [8501]	332
Rotophase activation direction (0 = Indirect, 1 = Direct) [8500]	333
Mains protections	334
Over/under frequency	334
Over frequency	334
Over frequency threshold [2500]	334
Over frequency timer [2501]	334
Over frequency control [2502]	334
Under frequency	335
Under frequency threshold [2503]	335
Under frequency timer [2504]	335
Under frequency control [2505]	335
Over frequency 2	335
Over frequency threshold 2 [2530]	335
Over frequency timer 2 [2531]	336
Over frequency control 2 [2532]	336
Under frequency 2	336
Under frequency threshold 2 [2533]	336
Under frequency timer 2 [2534]	336
Under frequency control 2 [2535]	337
Over/under voltage	337
Over voltage	337
Over voltage threshold [2506]	337
Over voltage timer [2507]	337
Over voltage control [2508]	338

Under voltage	338
Under voltage threshold [2509]	338
Under voltage timer [2510]	338
Under voltage control [2511]	338
Over voltage 2	339
Over voltage threshold 2 [2536]	339
Over voltage timer 2 [2537]	339
Over voltage control 2 [2538]	339
Under voltage 2	339
Under voltage threshold 2 [2539]	339
Under voltage timer 2 [2540]	340
Under voltage control 2 [2541]	340
Voltage/Current unbalance	340
Voltage unbalance	340
Voltage unbalance threshold [2565]	340
Voltage unbalance timer [2566]	340
Voltage unbalance control [2567]	341
Voltage unbalance 2	341
Voltage unbalance threshold 2 [2568]	341
Voltage unbalance timer 2 [2569]	341
Voltage unbalance control 2 [2570]	341
Current unbalance	342
Current unbalance threshold [2572]	342
Current unbalance timer [2573]	342
Current unbalance control [2574]	342
Current unbalance 2	342
Current unbalance threshold 2 [2575]	342
Current unbalance timer 2 [2576]	343
Current unbalance control 2 [2577]	343
Rotophase	343
Rotophase protection control [2585]	343
Rotophase activation direction (0 = Indirect, 1 = Direct) [2584]	343
Reverse kW/kVAR	344
Reverse kW	344
Reverse kW threshold [2518]	344
Reverse kW timer [2519]	344
Reverse kW control [2520]	344
Reverse kVAR	344
Reverse kVAR threshold [2527]	344
Reverse kVAR timer [2528]	345
Reverse kVAR control [2529]	345
Reverse kW 2	345
Reverse kW threshold 2 [2548]	345

OPERATOR MANUAL

Reverse kW timer 2 [2549]	345
Reverse kW control 2 [2550]	346
Reverse kVAR 2	346
Reverse kVAR threshold 2 [2557]	346
Reverse kVAR timer 2 [2558]	346
Reverse kVAR control 2 [2559]	346
Maximum/Minimum kW	347
Maximum kW	347
Maximum kW threshold [2515]	347
Maximum kW timer [2516]	347
Maximum kW control [2517]	347
Minimum kW	347
Minimum kW threshold [2512]	347
Minimum kW timer [2513]	348
Minimum kW control [2514]	348
Maximum kW 2	348
Maximum kW threshold 2 [2545]	348
Maximum kW timer 2 [2546]	348
Maximum kW control 2 [2547]	349
Minimum kW 2	349
Minimum kW threshold 2 [2542]	349
Minimum kW timer 2 [2543]	349
Minimum kW control 2 [2544]	349
Maxi kVAR/Mini kVAR	350
Maximum kVAR	350
Maximum kVAR threshold [2524]	350
Maximum kVAR timer [2525]	350
Maximum kVAR control [2526]	350
Minimum kVar	350
Minimum kVAR threshold [2521]	350
Minimum kVAR timer [2522]	351
Minimum kVAR control [2523]	351
Maximum kVAR 2	351
Maximum kVAR threshold 2 [2554]	351
Maximum kVAR timer 2 [2555]	351
Maximum kVAR control 2 [2556]	352
Minimum kVar 2	352
Minimum kVAR threshold 2 [2551]	352
Minimum kVAR timer 2 [2552]	352
Minimum kVAR control 2 [2553]	352
Vector jump/DF/DT	353
Vector jump	353
Vector jump threshold [2560]	353

Vector jump control [2561]	353
DF/DT	353
df/dt threshold [2562]	353
df/dt control [2563]	354
Init delay after mains paralleling	354
Vector jump and df/dt timer [2564]	354
Other protections	355
Analog inputs	355
Analog input 1	355
Analog input 1 threshold [2600]	355
Analog input 1 timer [2601]	355
Analog input 1 control [2602]	355
Analog input 1 threshold 2 [2603]	355
Analog input 1 timer 2 [2604]	356
Analog input 1 control 2 [2605]	356
Direction analog input 1 protection [2606]	356
Analog input 2	356
Analog input 2 threshold [2608]	356
Analog input 2 timer [2609]	357
Analog input 2 control [2610]	357
Analog input 2 threshold 2 [2611]	357
Analog input 2 timer 2 [2612]	357
Analog input 2 control 2 [2613]	358
Direction analog input 2 protection [2614]	358
Analog input 3	358
Analog input 3 threshold [2616]	358
Analog input 3 timer [2617]	358
Analog input 3 control [2618]	359
Analog input 3 threshold 2 [2619]	359
Analog input 3 timer 2 [2620]	359
Analog input 3 control 2 [2621]	359
Direction analog input 3 protection [2622]	360
Battery	360
Maximum battery voltage	360
Max. voltage battery threshold [2359]	360
Max. voltage battery timer [2360]	360
Max. voltage battery control [2361]	360
Minimum battery voltage	361
Min. voltage battery threshold [2356]	361
Min. voltage battery timer [2357]	361
Min. voltage battery control [2358]	361
Maximum battery voltage 2	361
Max. voltage battery threshold 2 [2377]	361

OPERATOR MANUAL

Max. voltage battery timer 2 [2378]	362
Max. voltage battery control 2 [2379]	362
Minimum battery voltage 2	362
Min. voltage battery threshold 2 [2374]	362
Min. voltage battery timer 2 [2375]	362
Min. voltage battery control 2 [2376]	363
CAN 1	363
Control on controllers communication fault [3052]	363
Control on missing GENSYS COMPACT PRIME on CAN bus [3054]	363
Control on missing MASTER COMPACT/BTB COMPACT on CAN bus [3057]	363
Control on missing HYBRID COMPACT on CAN bus [3060]	364
Control on missing BAT COMPACT on CAN bus [3061]	364
Control on not enough genset available [2399]	364
CANopen	364
Control on CANopen error [3059]	364
CANopen error timer [3152]	365
Mismatch rotophase	365
Mismatch rotophases protection control [2397]	365
PROGRAMMING	366
Hysteresis	366
Hysteresis 1	366
Enable Hysteresis 1 [2657]	366
Low level threshold [2660]	366
Timer on low level threshold [2666]	366
High level threshold [2663]	366
Timer on high level threshold [2669]	367
Hysteresis Direction 1 [2672]	367
Hysteresis 2	367
Enable Hysteresis 2 [2658]	367
Low level threshold [2661]	367
Timer on low level threshold [2667]	368
High level threshold [2664]	368
Timer on high level threshold [2670]	368
Hysteresis Direction 2 [2673]	368
Hysteresis 3	369
Enable Hysteresis 3 [2659]	369
Low level threshold [2662]	369
Timer on low level threshold [2668]	369
High level threshold [2665]	369
Timer on high level threshold [2671]	369
Hysteresis Direction 3 [2674]	370
Modbus	371

Connection settings	371
Enable connection to Modbus server [3031]	371
Control on Modbus server timeouts [3030]	371
Modbus server frame timeout [3032]	371
Modbus rights	371
Write date/time [3015.0]	371
Write engine meters [3015.1]	371
Write input functions [3015.3]	371
Reading via Modbus TCP [3015.8]	372
Writing via Modbus TCP [3015.9]	372
Logger	373
Activation	373
Activation [3610]	373
Variables 1-5	373
Log 1	373
Variable 1 to log [3600]	373
Log variable 1 on [3622]	373
Logging period variable 1 [3612]	374
Log 2	374
Variable 2 to log [3601]	374
Log variable 2 on [3623]	374
Logging period variable 2 [3613]	374
Log 3	375
Variable 3 to log [3602]	375
Log variable 3 on [3624]	375
Logging period variable 3 [3614]	375
Log 4	375
Variable 4 to log [3603]	375
Log variable 4 on [3625]	376
Logging period variable 4 [3615]	376
Log 5	376
Variable 5 to log [3604]	376
Log variable 5 on [3626]	376
Logging period variable 5 [3616]	377
Variables 6-10	377
Log 6	377
Variable 6 to log [3605]	377
Log variable 6 on [3627]	377
Logging period variable 6 [3617]	377
Log 7	378
Variable 7 to log [3606]	378
Log variable 7 on [3628]	378
Logging period variable 7 [3618]	378

Log 8	378
Variable 8 to log [3607]	378
Log variable 8 on [3629]	379
Logging period variable 8 [3619]	379
Log 9	379
Variable 9 to log [3608]	379
Log variable 9 on [3630]	379
Logging period variable 9 [3620]	380
Log 10	380
Variable 10 to log [3609]	380
Log variable 10 on [3631]	380
Logging period variable 10 [3621]	380
SYSTEM	381
LCD display	381
Screen saving	381
Screensaver timeout [3551]	381
Backlight	381
Backlight timeout [3552]	381
LCD screen backlight [3555]	381
LCD screen contrast [3554]	381
Date/Time	382
Day of the week [10]	382
Day [11]	382
Month [12]	382
Year [13]	382
Hours [14]	382
Minutes [15]	383
Buttons inhibition	384
Auto button inhibition [8102.14]	384
Test button inhibition [8102.13]	384
Man button inhibition [8102.12]	384
Start button inhibition [8102.11]	384
Stop button inhibition [8102.10]	384
Bus breaker button inhibition [8102.9]	384
Mains breaker button inhibition [8102.8]	384
Fault/Alarm/info button inhibition [8102.7]	384
Esc button inhibition [8102.6]	384
Enter button inhibition [8102.5]	384
Up arrow button inhibition [8102.4]	385
Left arrow button inhibition [8102.3]	385
Down arrow button inhibition [8102.2]	385
Right arrow button inhibition [8102.1]	385

Shift button inhibition [8102.0]	385
LIST OF INPUTS	386
Bus	386
Bus breaker feedback [4501]	386
Remote start on load [4502]	386
Remote start off load [4611]	386
Remote start with timer [4612]	386
Power plant ready [4636]	386
Mains	387
Mains breaker feedback [4500]	387
Manual mains back [4544]	387
Mains failure [4638]	387
Mains available [4642]	387
Inputs/outputs	388
Digital output 1 forced [4630]	388
Digital output 2 forced [4631]	388
Digital output 3 forced [4632]	388
Digital output 4 forced [4633]	388
Digital output 5 forced [4634]	388
Digital output 6 forced [4635]	388
Relay 1 forced [4950]	388
Relay 2 forced [4951]	388
Power Plant	389
External non essential trip request [4537]	389
Alarms/faults	390
Emergency stop [4505]	390
Bus fault request (Trip) [4507]	390
Mains fault request [4508]	390
Remote soft shut down [4526]	390
Remote alarm [4527]	390
Alternative selections	391
Alternative selection 1 [4594]	391
Alternative selection 2 [4595]	391
Alternative selection 3 [4596]	391
Alternative selection 4 [4597]	391
Alternative selection 5 [4598]	391
Alternative selection 6 [4599]	391
Alternative selection 7 [4600]	391
Alternative selection 8 [4601]	391
Alternative selection 9 [4602]	391
Alternative selection 10 [4603]	392
Alternative selection 11 [4604]	392

Alternative selection 12 [4605]	392
Alternative selection 13 [4606]	392
Alternative selection 14 [4607]	392
Alternative selection 15 [4608]	392
Alternative selection 16 [4609]	392
Hysteresis	393
Hysteresis low threshold DI1 [4614]	393
Hysteresis low threshold DI2 [4615]	393
Hysteresis low threshold DI3 [4616]	393
Hysteresis low threshold DI4 [4617]	393
Hysteresis low threshold DI5 [4618]	393
Hysteresis low threshold DI6 [4619]	393
Hysteresis low threshold DI7 [4620]	393
Hysteresis low threshold DI8 [4621]	393
Hysteresis high threshold DI1 [4622]	393
Hysteresis high threshold DI2 [4623]	393
Hysteresis high threshold DI3 [4624]	394
Hysteresis high threshold DI4 [4625]	394
Hysteresis high threshold DI5 [4626]	394
Hysteresis high threshold DI6 [4627]	394
Hysteresis high threshold DI7 [4628]	394
Hysteresis high threshold DI8 [4629]	394
Remote buttons	395
Remote faults reset [4506]	395
Manual start request [4509]	395
Manual stop request [4510]	395
Manual mode request [4511]	395
Manual mode inhibition [4512]	395
Auto mode request [4513]	395
Bus breaker opening in manual mode [4518]	395
Mains breaker opening in manual mode [4519]	395
Bus breaker closing in manual mode [4520]	395
Mains breaker closing in manual mode [4521]	396
Stop horn [4530]	396
Led test [4580]	396
Test mode request [4590]	396
LIST OF OUTPUTS	397
Commands	397
Horn [4663]	397
Bus breaker closure [4675]	397
Mains breaker close [4676]	397
Bus breaker opening [4677]	397

OPERATOR MANUAL

Mains breaker open [4678]	397
1st non essential trip [4689]	397
2nd non essential trip [4690]	397
3rd non essential trip [4691]	397
4th non essential trip [4692]	397
5th non essential trip [4693]	398
Unload breaker n°1 [4721]	398
Unload breaker n°2 [4722]	398
Unload breaker n°3 [4723]	398
Unload breaker n°4 [4724]	398
Unload breaker n°5 [4725]	398
Unload breaker n°6 [4726]	398
Unload breaker n°7 [4727]	398
Unload breaker n°8 [4728]	398
Unload breaker n°9 [4729]	399
Unload breaker n°10 [4730]	399
Faults reset [4737]	399
Bus	400
Fail to close bus breaker [4154]	400
Fail to open bus breaker [4155]	400
Bus breaker open suddenly [4156]	400
Bus breaker close suddenly [4170]	400
Bus breaker state [4650]	400
Power plant ready [4670]	400
Power plant ready and breaker closed [4672]	400
Mains	401
Fail to close mains breaker [4157]	401
Fail to open mains breaker [4158]	401
Mains breaker open suddenly [4159]	401
Mains breaker close suddenly [4171]	401
Mains breaker state [4651]	401
Bus/Mains voltage presence [4703]	401
Inputs/outputs	402
Input 1 (Customisable) [250]	402
Input 2 (Customisable) [251]	402
Input 3 (Customisable) [252]	402
Input 4 (Customisable) [253]	403
Input 5 (Customisable) [254]	403
Input 6 (Customisable) [255]	403
Input 7 (Customisable) [256]	404
Input 8 (Customisable) [257]	404
Input 9 (Customisable) [258]	404
Analog 1 (Customisable) [259]	404

OPERATOR MANUAL

Analog 2 (Customisable) [260]	404
Analog 3 (Customisable) [261]	405
Physical status of digital input 1 [953.0]	405
Physical status of digital input 2 [953.1]	405
Physical status of digital input 3 [953.2]	405
Physical status of digital input 4 [953.3]	405
Physical status of digital input 5 [953.4]	405
Physical status of digital input 6 [953.5]	405
Physical status of digital input 7 [953.6]	405
Physical status of digital input 8 [953.7]	405
Physical status of digital input 9 [953.8]	406
Output 1 (Customisable) [4350]	406
Output 2 (Customisable) [4351]	406
Output 3 (Customisable) [4352]	406
Output 4 (Customisable) [4353]	406
Output 5 (Customisable) [4354]	406
Output 6 (Customisable) [4355]	406
Relay 1 (Customisable) [4356]	406
Relay 2 (Customisable) [4357]	406
I/O CAN bus expansion	407
CANopen DI 1 (Customisable) [800]	407
CANopen DI 2 (Customisable) [801]	407
CANopen DI 3 (Customisable) [802]	407
CANopen DI 4 (Customisable) [803]	407
CANopen DI 5 (Customisable) [804]	407
CANopen DI 6 (Customisable) [805]	407
CANopen DI 7 (Customisable) [806]	407
CANopen DI 8 (Customisable) [807]	407
CANopen DI 9 (Customisable) [808]	407
CANopen DI 10 (Customisable) [809]	407
CANopen DI 11 (Customisable) [810]	408
CANopen DI 12 (Customisable) [811]	408
CANopen DI 13 (Customisable) [812]	408
CANopen DI 14 (Customisable) [813]	408
CANopen DI 15 (Customisable) [814]	408
CANopen DI 16 (Customisable) [815]	408
CANopen DI 17 (Customisable) [816]	408
CANopen DI 18 (Customisable) [817]	408
CANopen DI 19 (Customisable) [818]	408
CANopen DI 20 (Customisable) [819]	408
CANopen DI 21 (Customisable) [820]	408
CANopen DI 22 (Customisable) [821]	409
CANopen DI 23 (Customisable) [822]	409

OPERATOR MANUAL

CANopen DI 24 (Customisable) [823]	409
CANopen DI 25 (Customisable) [824]	409
CANopen DI 26 (Customisable) [825]	409
CANopen DI 27 (Customisable) [826]	409
CANopen DI 28 (Customisable) [827]	409
CANopen DI 29 (Customisable) [828]	409
CANopen DI 30 (Customisable) [829]	409
CANopen DI 31 (Customisable) [830]	409
CANopen DI 32 (Customisable) [831]	409
CANopen DI 33 (Customisable) [1250]	410
CANopen DI 34 (Customisable) [1251]	410
CANopen DI 35 (Customisable) [1252]	410
CANopen DI 36 (Customisable) [1253]	410
CANopen DI 37 (Customisable) [1254]	410
CANopen DI 38 (Customisable) [1255]	410
CANopen DI 39 (Customisable) [1256]	410
CANopen DI 40 (Customisable) [1257]	410
CANopen DI 41 (Customisable) [1258]	410
CANopen DI 42 (Customisable) [1259]	410
CANopen DI 43 (Customisable) [1260]	410
CANopen DI 44 (Customisable) [1261]	411
CANopen DI 45 (Customisable) [1262]	411
CANopen DI 46 (Customisable) [1263]	411
CANopen DI 47 (Customisable) [1264]	411
CANopen DI 48 (Customisable) [1265]	411
CANopen DI 49 (Customisable) [1266]	411
CANopen DI 50 (Customisable) [1267]	411
CANopen DI 51 (Customisable) [1268]	411
CANopen DI 52 (Customisable) [1269]	411
CANopen DI 53 (Customisable) [1270]	411
CANopen DI 54 (Customisable) [1271]	411
CANopen DI 55 (Customisable) [1272]	412
CANopen DI 56 (Customisable) [1273]	412
CANopen DI 57 (Customisable) [1274]	412
CANopen DI 58 (Customisable) [1275]	412
CANopen DI 59 (Customisable) [1276]	412
CANopen DI 60 (Customisable) [1277]	412
CANopen DI 61 (Customisable) [1278]	412
CANopen DI 62 (Customisable) [1279]	412
CANopen DI 63 (Customisable) [1280]	412
CANopen DI 64 (Customisable) [1281]	412
CANopen DO 1 (Customisable) [4751]	412
CANopen DO 2 (Customisable) [4752]	413

OPERATOR MANUAL

CANopen DO 3 (Customisable) [4753]	413
CANopen DO 4 (Customisable) [4754]	413
CANopen DO 5 (Customisable) [4755]	413
CANopen DO 6 (Customisable) [4756]	413
CANopen DO 7 (Customisable) [4757]	413
CANopen DO 8 (Customisable) [4758]	413
CANopen DO 9 (Customisable) [4759]	413
CANopen DO 10 (Customisable) [4760]	413
CANopen DO 11 (Customisable) [4761]	413
CANopen DO 12 (Customisable) [4762]	413
CANopen DO 13 (Customisable) [4763]	414
CANopen DO 14 (Customisable) [4764]	414
CANopen DO 15 (Customisable) [4765]	414
CANopen DO 16 (Customisable) [4766]	414
CANopen DO 17 (Customisable) [4767]	414
CANopen DO 18 (Customisable) [4768]	414
CANopen DO 19 (Customisable) [4769]	414
CANopen DO 20 (Customisable) [4770]	414
CANopen DO 21 (Customisable) [4771]	414
CANopen DO 22 (Customisable) [4772]	414
CANopen DO 23 (Customisable) [4773]	414
CANopen DO 24 (Customisable) [4774]	415
CANopen DO 25 (Customisable) [4775]	415
CANopen DO 26 (Customisable) [4776]	415
CANopen DO 27 (Customisable) [4777]	415
CANopen DO 28 (Customisable) [4778]	415
CANopen DO 29 (Customisable) [4779]	415
CANopen DO 30 (Customisable) [4780]	415
CANopen DO 31 (Customisable) [4781]	415
CANopen DO 32 (Customisable) [4782]	415
CANopen DO 33 (Customisable) [5100]	415
CANopen DO 34 (Customisable) [5101]	415
CANopen DO 35 (Customisable) [5102]	416
CANopen DO 36 (Customisable) [5103]	416
CANopen DO 37 (Customisable) [5104]	416
CANopen DO 38 (Customisable) [5105]	416
CANopen DO 39 (Customisable) [5106]	416
CANopen DO 40 (Customisable) [5107]	416
CANopen DO 41 (Customisable) [5108]	416
CANopen DO 42 (Customisable) [5109]	416
CANopen DO 43 (Customisable) [5110]	416
CANopen DO 44 (Customisable) [5111]	416
CANopen DO 45 (Customisable) [5112]	416

OPERATOR MANUAL

CANopen DO 46 (Customisable) [5113]	417
CANopen DO 47 (Customisable) [5114]	417
CANopen DO 48 (Customisable) [5115]	417
CANopen DO 49 (Customisable) [5116]	417
CANopen DO 50 (Customisable) [5117]	417
CANopen DO 51 (Customisable) [5118]	417
CANopen DO 52 (Customisable) [5119]	417
CANopen DO 53 (Customisable) [5120]	417
CANopen DO 54 (Customisable) [5121]	417
CANopen DO 55 (Customisable) [5122]	417
CANopen DO 56 (Customisable) [5123]	417
CANopen DO 57 (Customisable) [5124]	418
CANopen DO 58 (Customisable) [5125]	418
CANopen DO 59 (Customisable) [5126]	418
CANopen DO 60 (Customisable) [5127]	418
CANopen DO 61 (Customisable) [5128]	418
CANopen DO 62 (Customisable) [5129]	418
CANopen DO 63 (Customisable) [5130]	418
CANopen DO 64 (Customisable) [5131]	418
Power Plant	419
Generator No.1 circuit breaker position [562.0]	419
Generator No.2 circuit breaker position [562.1]	419
Generator No.3 circuit breaker position [562.2]	419
Generator No.4 circuit breaker position [562.3]	419
Generator No.5 circuit breaker position [562.4]	419
Generator No.6 circuit breaker position [562.5]	419
Generator No.7 circuit breaker position [562.6]	419
Generator No.8 circuit breaker position [562.7]	419
Generator No.9 circuit breaker position [562.8]	419
Generator No.10 circuit breaker position [562.9]	419
Generator No.11 circuit breaker position [562.10]	420
Generator No.12 circuit breaker position [562.11]	420
Generator No.13 circuit breaker position [562.12]	420
Generator No.14 circuit breaker position [562.13]	420
Generator No.15 circuit breaker position [562.14]	420
Generator No.16 circuit breaker position [562.15]	420
Generator No.17 circuit breaker position [563.0]	420
Generator No.18 circuit breaker position [563.1]	420
Generator No.19 circuit breaker position [563.2]	420
Generator No.20 circuit breaker position [563.3]	420
Generator No.21 circuit breaker position [563.4]	420
Generator No.22 circuit breaker position [563.5]	421
Generator No.23 circuit breaker position [563.6]	421

OPERATOR MANUAL

Generator No.24 circuit breaker position [563.7]	421
Generator No.25 circuit breaker position [563.8]	421
Generator No.26 circuit breaker position [563.9]	421
Generator No.27 circuit breaker position [563.10]	421
Generator No.28 circuit breaker position [563.11]	421
Generator No.29 circuit breaker position [563.12]	421
Generator No.30 circuit breaker position [563.13]	421
Generator No.31 circuit breaker position [563.14]	421
Generator No.32 circuit breaker position [563.15]	421
Mains/tie breaker No.1 circuit breaker position [976.0]	422
Mains/tie breaker No.2 circuit breaker position [976.1]	422
Mains/tie breaker No.3 circuit breaker position [976.2]	422
Mains/tie breaker No.4 circuit breaker position [976.3]	422
Mains/tie breaker No.5 circuit breaker position [976.4]	422
Mains/tie breaker No.6 circuit breaker position [976.5]	422
Mains/tie breaker No.7 circuit breaker position [976.6]	422
Mains/tie breaker No.8 circuit breaker position [976.7]	423
Mains/tie breaker No.9 circuit breaker position [976.8]	423
Mains/tie breaker No.10 circuit breaker position [976.9]	423
Mains/tie breaker No.11 circuit breaker position [976.10]	423
Mains/tie breaker No.12 circuit breaker position [976.11]	423
Mains/tie breaker No.13 circuit breaker position [976.12]	423
Mains/tie breaker No.14 circuit breaker position [976.13]	423
Mains/tie breaker No.15 circuit breaker position [976.14]	424
Mains/tie breaker No.16 circuit breaker position [976.15]	424
Mains/tie breaker No.17 circuit breaker position [977.0]	424
Mains/tie breaker No.18 circuit breaker position [977.1]	424
Mains/tie breaker No.19 circuit breaker position [977.2]	424
Mains/tie breaker No.20 circuit breaker position [977.3]	424
Mains/tie breaker No.21 circuit breaker position [977.4]	424
Mains/tie breaker No.22 circuit breaker position [977.5]	425
Mains/tie breaker No.23 circuit breaker position [977.6]	425
Mains/tie breaker No.24 circuit breaker position [977.7]	425
Mains/tie breaker No.25 circuit breaker position [977.8]	425
Mains/tie breaker No.26 circuit breaker position [977.9]	425
Mains/tie breaker No.27 circuit breaker position [977.10]	425
Mains/tie breaker No.28 circuit breaker position [977.11]	425
Mains/tie breaker No.29 circuit breaker position [977.12]	426
Mains/tie breaker No.30 circuit breaker position [977.13]	426
Mains/tie breaker No.31 circuit breaker position [977.14]	426
Mains/tie breaker No.32 circuit breaker position [977.15]	426
Mains presence on the common bus bar [4032]	426
Bus protections	427

OPERATOR MANUAL

Fail to synchronize [4051]	427
Mismatch rotophases level 1 [4053.0]	427
Mismatch rotophases level 2 [4053.1]	427
Bus over frequency level 1 [4250.0]	427
Bus over frequency level 2 [4250.1]	427
Bus under frequency level 1 [4251.0]	427
Bus under frequency level 2 [4251.1]	427
Bus over voltage level 1 [4252.0]	427
Bus over voltage level 2 [4252.1]	427
Bus under voltage level 1 [4253.0]	427
Bus under voltage level 2 [4253.1]	428
Bus minimum KW level 1 [4254.0]	428
Bus minimum KW level 2 [4254.1]	428
Bus maximum KW level 1 [4255.0]	428
Bus maximum KW level 2 [4255.1]	428
Bus reverse KW level 1 [4256.0]	428
Bus reverse KW level 2 [4256.1]	428
Bus minimum KVAR level 1 [4257.0]	428
Bus minimum KVAR level 2 [4257.1]	428
Bus maximum KVAR level 1 [4258.0]	428
Bus maximum KVAR level 2 [4258.1]	428
Bus reverse KVAR level 1 [4259.0]	429
Bus reverse KVAR level 2 [4259.1]	429
Bus maximum current level 1 [4260.0]	429
Bus maximum current level 2 [4260.1]	429
Bus short-circuit level 1 [4262.0]	429
Bus short-circuit level 2 [4262.1]	429
Bus voltage unbalance level 1 [4268.0]	429
Bus voltage unbalance level 2 [4268.1]	429
Not enough genset available level 1 [4270.0]	429
Not enough genset available level 2 [4270.1]	429
No genset available [4271]	429
Bus rotophase level 1 [4272.0]	430
Bus rotophase level 2 [4272.1]	430
Mains protections	431
Mains over frequency level 1 [4300.0]	431
Mains over frequency level 2 [4300.1]	431
Mains under frequency level 1 [4301.0]	431
Mains under frequency level 2 [4301.1]	431
Mains over voltage level 1 [4302.0]	431
Mains over voltage level 2 [4302.1]	431
Mains under voltage level 1 [4303.0]	431
Mains under voltage level 2 [4303.1]	431

OPERATOR MANUAL

Mains minimum KW level 1 [4304.0]	431
Mains minimum KW level 2 [4304.1]	431
Mains maximum KW level 1 [4305.0]	432
Mains maximum KW level 2 [4305.1]	432
Mains reverse KW level 1 [4306.0]	432
Mains reverse KW level 2 [4306.1]	432
Mains minimum KVAR level 1 [4307.0]	432
Mains minimum KVAR level 2 [4307.1]	432
Mains maximum KVAR level 1 [4308.0]	432
Mains maximum KVAR level 2 [4308.1]	432
Mains reverse KVAR level 1 [4309.0]	432
Mains reverse KVAR level 2 [4309.1]	432
Vector jump level 1 [4310.0]	432
Vector jump level 2 [4310.1]	433
df/dt level 1 [4311.0]	433
df/dt level 2 [4311.1]	433
Mains voltage unbalance level 1 [4314.0]	433
Mains voltage unbalance level 2 [4314.1]	433
Bus current unbalance level 1 [4316.0]	433
Bus current unbalance level 2 [4316.1]	433
Mains rotophase level 1 [4318.0]	433
Mains rotophase level 2 [4318.1]	433
Other protections	434
Battery minimum voltage level 1 [4202.0]	434
Battery minimum voltage level 2 [4202.1]	434
Battery maximum voltage level 1 [4203.0]	434
Battery maximum voltage level 2 [4203.1]	434
Communication	435
Controller communication fault [600]	435
Missing GENSYS COMPACT PRIME [605]	435
Missing MASTER COMPACT or BTB COMPACT [608]	435
Missing HYBRID COMPACT [612]	435
Missing BAT COMPACT [613]	435
Modbus server (Customisable) [904]	435
CANopen fault [4750]	435
Statuses	436
Phase sequence match [306]	436
Voltage match [307]	436
Frequency match [308]	436
Phase match [309]	436
Synch check relay OK [310]	436
Production request [4007]	436
Bus electrical fault summary [4656]	436

OPERATOR MANUAL

Mains electrical fault summary [4657]	436
Alarms summary [4658]	436
Soft shut down summary [4659]	437
Default LED [4664]	437
Alarm LED [4665]	437
Auto mode LED [4666]	437
Test mode LED [4667]	437
Manu mode LED [4668]	437
Bus LED [4669]	437
Protection validation [4681]	437
Mains failure summary [4731]	437
Bus breaker LED [4734]	437
Mains breaker LED [4735]	438
Mains LED [4736]	438
Hysteresis	439
Hysteresis 1 output [4710]	439
Hysteresis 2 output [4711]	439
Hysteresis 3 output [4712]	439
Hysteresis output activation on DI1 [4713]	439
Hysteresis output activation on DI2 [4714]	439
Hysteresis output activation on DI3 [4715]	439
Hysteresis output activation on DI4 [4716]	439
Hysteresis output activation on DI5 [4717]	439
Hysteresis output activation on DI6 [4718]	439
Hysteresis output activation on DI7 [4719]	440
Hysteresis output activation on DI8 [4720]	440
Remote buttons	441
Shift button [951.0]	441
Right arrow button [951.1]	441
Down arrow button [951.2]	441
Left arrow button [951.3]	441
Up arrow button [951.4]	441
Enter button [951.5]	441
Esc button [951.6]	441
Fault/Alarm/info button [951.7]	441
Mains breaker button [951.8]	441
Bus breaker button [951.9]	441
Stop button [951.10]	442
Start button [951.11]	442
Man button [951.12]	442
Test button [951.13]	442
Auto button [951.14]	442

DYNAMIC

SYNCHRONIZATION PID

Variable	Gain Synch [2904]
Unit	-
Init value	10
Min value	0
Max value	100
Description	This variable sets the global Gain of phase synchronization PID. The global Gain is the multiplier of the proportional, integral and derivative values. A too high value will cause a pumping, a too low value will cause a low reaction, We can compare it to a nervousness Gain.

Variable	Proport. Synch [2905]
Unit	-
Init value	10
Min value	0
Max value	100
Description	<p>This parameter should only be changed if the system has not been correctly regulated by changing the Gain alone. In this case, refer to the chapter "Control Loop PID" in the technical documentation of your product for a step-by-step method of adjustment.</p> <p>As a general rule :</p> <ul style="list-style-type: none"> - G must remain fixed, neither too low nor too high, it multiplies the 3 other components - Set P, I and D to 0 - Increase P until you have a system that corrects quickly enough, without major instabilities. In most cases, an error persists between the measurement and the setpoint (value to be reached). - Increase I to correct this persistent error over time. - Increase D to reduce the oscillations, if they exist. <p>Phase regulation is active during synchronization if the frequency of the generator(s) is close to the frequency setpoint (value to be reached for coupling). When the generator frequency is too far from the frequency setpoint, the phase regulation is not active, only the frequency regulation is.</p> <p>Therefore, to correctly adjust the phase regulation, it is necessary to have a frequency on the generator close to the frequency setpoint, by modifying the offset for example, or by having correctly adjusted the frequency regulation beforehand.</p>

Variable	Integral Synch [2906]
Unit	-
Init value	0
Min value	0
Max value	100
Description	<p>This parameter should only be changed if the system has not been correctly regulated by changing the Gain alone. In this case, refer to the chapter "Control Loop PID" in the technical documentation of your product for a step-by-step method of adjustment.</p> <p>As a general rule :</p> <ul style="list-style-type: none"> - G must remain fixed, neither too low nor too high, it multiplies the 3 other components - Set P, I and D to 0 - Increase P until you have a system that corrects quickly enough, without major instabilities. In most cases, an error persists between the measurement and the setpoint (value to be reached). - Increase I to correct this persistent error over time. - Increase D to reduce the oscillations, if they exist. <p>Phase regulation is active during synchronization if the frequency of the generator(s) is close to the frequency setpoint (value to be reached for coupling). When the generator frequency is too far from the frequency setpoint, the phase regulation is not active, only the frequency regulation is.</p> <p>Therefore, to correctly adjust the phase regulation, it is necessary to have a frequency on the generator close to the frequency setpoint, by modifying the offset for example, or by having correctly adjusted the frequency regulation beforehand.</p>

Variable	Derivate Synch [2907]
Unit	-
Init value	0
Min value	0
Max value	100
Description	<p>This parameter should only be changed if the system has not been correctly regulated by changing the Gain alone. In this case, refer to the chapter "Control Loop PID" in the technical documentation of your product for a step-by-step method of adjustment.</p> <p>As a general rule :</p> <ul style="list-style-type: none"> - G must remain fixed, neither too low nor too high, it multiplies the 3 other components - Set P, I and D to 0 - Increase P until you have a system that corrects quickly enough, without major instabilities. In most cases, an error persists between the measurement and the setpoint (value to be reached). - Increase I to correct this persistent error over time. - Increase D to reduce the oscillations, if they exist. <p>Phase regulation is active during synchronization if the frequency of the generator(s) is close to the frequency setpoint (value to be reached for coupling). When the generator frequency is too far from the frequency setpoint, the phase regulation is not active, only the frequency regulation is.</p> <p>Therefore, to correctly adjust the phase regulation, it is necessary to have a frequency on the generator close to the frequency setpoint, by modifying the offset for example, or by having correctly adjusted the frequency regulation beforehand.</p>

GENERAL

APPLICATION

General

Variable	My number [2001]
Unit	-
Init value	1
Min value	1
Max value	32
Description	<p>This parameter is used to define the product identifier for communication between products.</p> <p>It must be unique for each controller 'type':</p> <ul style="list-style-type: none"> - Number GENSYS COMPACT from first to last (32 maximum) - Number MASTER COMPACT, MASTER COMPACT 1B and BTB COMPACT from first to last (32 maximum) - Number HYBRID COMPACT from first to last (32 maximum) - Number BAT COMPACT from first to last (max. 32)

Variable	Number of GENSYS COMPACT PRIME [2000]
Unit	-
Init value	2
Min value	0
Max value	32
Description	Number of GENSYS COMPACT PRIME on the power plant. This parameter is used for the CAN communication between products.

Variable	Number of MASTER COMPACT/BTB COMPACT [2017]
Unit	-
Init value	1
Min value	0
Max value	32
Description	Number of MASTER COMPACT / MASTER COMPACT 1B / BTB (combined) on the power plant. This parameter is used for the CAN communication between products.

OPERATOR MANUAL

Variable	Type of application [2005]
Unit	-
Init value	1
List	0: Change over 1: No break change over 2: Permanent
Description	<p>This parameter is used to select the mode of operation between the generator(s) and the mains. 3 values can be selected:</p> <ul style="list-style-type: none"> - Change over : Load transfer between the generator(s) and the mains without synchronization/paralleling. - No break change over : Load transfer between the generator(s) and the mains with synchronization/paralleling/progressive power transfer. - Permanent: Synchronization/paralleling to the mains permanently. This mode has to be selected to set a fixed power to the mains (Peak shaving) or to set a fixed power to the generator (Base load). Caution: In this mode of operation, the activation of the df/dt protection is strongly recommended to detect the loss of the mains during permanent paralleling.

Variable	Type of regulation [2006]
Unit	-
Init value	0
List	0: Peak shaving 1: Base load GE
Description	<p>This parameter is used to select the type of consignment when the generator(s) is(are) permanently paralleled to the mains. 2 values can be selected:</p> <ul style="list-style-type: none"> - Peak shaving : Fixed active power on the mains, the active power of the generator(s) changes with the load. If the generator(s) reach(s) the high limit, the mains consignment will no longer be respected. - Base load : Fixed active power on the generator(s), the active power of the mains changes with the load.

OPERATOR MANUAL

Variable	Connection type [2003]
Unit	-
Init value	2
List	0: Monophase 1: Biphase 180° 2: Triphase 120° (3 or 4 wires) 3: Triphase L1-N-L2 4: Triphase L2-N-L3 5: Triphase L3-N-L1
Description	This parameter is used to select the voltage system that will be applied to all the voltage sources managed by the product. 6 values can be selected: <ul style="list-style-type: none"> - Single phase: Connection of one active phase and one neutral. Connect the voltages on terminals L1-N. Connect the currents on I1-IN. - Two phase 180°: Connection of 2 active phases (and an optional neutral). Connect the voltages to terminals L1-L3 (and optional N). Connect the currents to I1-I3-IN. If the neutral is not connected to the voltage terminal block, the product will calculate a virtual neutral by itself. - Three-phase 120°: Connection of 3 active phases (and an optional neutral). Connect the voltages on terminals L1-L2-L3 (and optional N). Connect the currents to I1-I2-I3-IN. If the neutral is not connected to the voltage terminal block, the product will calculate a virtual neutral by itself. - Three-phase L1-N-L2: Connection of 3 active phases and a neutral. High leg on L3, neutral between L1 and L2. The neutral must be connected. - Three-phase L2-N-L3: Connection of 3 active phases and a neutral. High leg on L1, neutral between L2 and L3. The neutral must be connected. - Three-phase L3-N-L1: Connection of 3 active phases and a neutral. High leg on L2, neutral between L3 and L1. The neutral must be connected.

Mode

Variable	Power on mode [2012]
Unit	-
Init value	0
List	0: Manual 1: Test 2: Auto
Description	This parameter is used to select the mode of the product when the power supply is applied. 3 values can be used : <ul style="list-style-type: none"> - Manual : The product will switch-on on Manual mode - Test : The product will switch-on on Test mode - Auto : The product will switch-on on Auto mode

OPERATOR MANUAL

Variable	Test mode operation [2014]
Unit	-
Init value	0
List	0: On load 1: Off load 2: On load with timer
Description	This parameter is used to select the actions for test mode on the product. 3 values can be used : - On load : The generator(s) start(s) and the breaker(s) close(s) to take the load. - Off load : The generator(s) start(s) but the breaker does not close. - On load with timer :The generator start, run without load during a configurable timer, and the breaker closes.

Variable	Limited time test mode [2015]
Unit	-
Init value	0
List	0: No 1: Yes
Description	This parameter is used to activate an operation delay in test mode. During this timer, the test mode is activated. At the end of this timer, the product will be forced on auto mode and the generator will stop if there is no active remote start.

Variable	Test mode duration [2016]
Unit	s
Init value	600
Min value	0
Max value	65535
Description	This parameter allows you to set the time for which the product will remain in test mode if the limited time test mode has been activated.

Synchronization & Load Sharing only

Variable	Synchronization & Load sharing only [2024]
Unit	-
Init value	0
List	0: No 1: Yes
Description	<p>This parameter determines if the product should process only synchronization and kW/kVAR management. 2 values can be selected:</p> <ul style="list-style-type: none"> - No: Standard operation of the product with management of the faults when the feedback of the circuit breakers is not in conformity with the orders of the product, management of the engine. - Yes: Circuit-breaker faults are not managed, which leaves more flexibility in sequences when circuit-breaker close/open commands are given by a PLC. The engine sequence is not managed. The product will start the synchronization sequence if voltage and frequency are between 95% and 105% of nominal and a digital input configured as 'Remote start on load' is activated. The kW management function is activated as soon as a digital input configured as 'Generator breaker feedback' is activated. In this operating mode, the product can only be used in automatic mode.

TIMERS

Start sequence

Variable	Stabilization timer on can fault [3469]
Unit	s
Init value	20.0
Min value	0.0
Max value	999.9
Description	This delay corresponds to the time the MASTER waits before closing the bus breaker in case of a CAN fault and after the bus frequency and voltage have reached their nominal values

Variable	Delay before activation of the protections [2004]
Unit	s
Init value	10.0
Min value	0.0
Max value	999.9
Description	Waiting time before activating protections once the power plant is ready.

Variable	Off load timer (Only for start with timer) [3478]
Unit	s
Init value	1800.0
Min value	0.0
Max value	6553.5
Description	This delay is used during a start on load with delay, either by activating a digital input configured as "Start on load with delay" in auto mode, or by using the test mode by having configured the product to do a "Start on load with delay" test. It corresponds to the waiting time between the end of the engine sequence and the closure of the generator breaker.

Ramp timer

Variable	Load ramp timer [2853]
Unit	s
Init value	30.0
Min value	0.0
Max value	1600.0
Description	<p>This setpoint adjusts the load ramp timer, for load sharing or mains paralleling mode.</p> <p>In case of a battery it adjusts the discharge ramp timer.</p> <p>100 % of this timer corresponds to transfer 100% of generator/power plant/battery nominal kW.</p> <p>For a ramp, to transfer, from 10% to 60% of nominal kW, the time will be 50% of the set timer.</p>

Variable	Unload ramp timer [2856]
Unit	s
Init value	30.0
Min value	0.0
Max value	1600.0
Description	<p>This setpoint adjusts the unload ramp timer, for load sharing or mains paralleling mode.</p> <p>In case of a battery it adjusts the charge ramp timer.</p> <p>100 % of this timer corresponds to transfer 100% of generator/power plant nominal kW.</p> <p>For a ramp, to transfer, from 60% to 10% of nominal kW, the time will be 50% of the set timer.</p>

Others

Variable	Horn timer [2478]
Unit	s
Init value	1.0
Min value	0.0
Max value	6553.5
Description	<p>Duration of activation of the horn which is activated each time an alarm or fault occurs on the product. The value 0 means that the horn will sound until the alarms/faults on the product are manually acknowledged.</p>

Mains timers

Variable	Mains back timer [2009]
Unit	s
Init value	10.0
Min value	0.0
Max value	6553.5
Description	Waiting time between the moment when the mains returns (no longer any protection configured as mains failure is active) and the moment when the sequence to return to the mains is started.

Variable	Change over timer [2007]
Unit	s
Init value	1.0
Min value	0.1
Max value	999.9
Description	This timer corresponds to the waiting time between the opening of the generator/bus breaker and the closing of the mains breaker or vice versa.

CAN

CAN 1

Variable	CAN 1 baud rate [3050]
Unit	-
Init value	125
List	125: 125 kBit/s 250: 250 kBit/s 500: 500 kBit/s 1000: 1000 kBit/s
Description	CAN bus speed 1: - Used for communication between products with the proprietary CRE protocol (Only for communicating products). - Used for the connection of inputs/outputs with the CANopen protocol when the MTU MDEC protocol is activated on CAN 2 (Only for products with engine control). Higher speed results in a reduction of the maximum bus distance.

Variable	Inhibition remote start from CAN [2018]
Unit	-
Init value	0
List	0: No 1: Yes
Description	Allows a unit to ignore a remote start request coming from another product connected via CAN

CAN 2

Variable	CAN 2 baud rate [3051]
Unit	-
Init value	125
List	125: 125 kBit/s 250: 250 kBit/s 500: 500 kBit/s 1000: 1000 kBit/s
Description	<p>CAN bus speed 2:</p> <ul style="list-style-type: none"> - Used for connecting inputs/outputs with the CANopen protocol (Except when using the MDEC protocol, in which case the CANopen inputs/outputs must be connected to CAN 1). If the J1939 protocol is disabled, this parameter determines the communication speed of the CAN 2 bus. - Used for the communication between the product and the ECU with the J1939 protocol (Only for products with engine control). When the J1939 protocol is enabled, the CAN 2 bus speed is forced to 250kb/s. This parameter will not impact the bus speed. - Used for the communication between the product and the ECU with the MDEC protocol (Only for products with engine control). When the MDEC protocol is enabled, the CAN 2 bus speed is forced to 125kb/s. This parameter will not impact the bus speed. <p>A higher speed results in a reduction of the maximum bus distance.</p>

Segment

Variable	Segment number [2020]
Unit	-
Init value	1
Min value	1
Max value	33
Description	Segment number of the unit

EVENTS

Variable	Record power up [8300]
Unit	-
Init value	1
List	0: No 1: Yes
Description	Records controller power up event

Variable	Record mains status [8302]
Unit	-
Init value	1
List	0: No 1: Yes
Description	Records mains failure and mains back events

Variable	Record circuit breaker status (Open/Closed) [8303]
Unit	-
Init value	1
List	0: No 1: Yes
Description	Records breaker closing and opening events

Variable	Record operating mode [8304]
Unit	-
Init value	1
List	0: No 1: Yes
Description	Records controller mode switching events (automatic, test, manual)

METERS

Variable	Mains kWh [120]
Unit	kWh
Init value	0
Min value	0
Max value	4294967295
Description	Mains kWh (lower bytes)

Variable	Mains kVARh energy [122]
Unit	kVARh
Init value	0
Min value	0
Max value	4294967295
Description	Mains kVARH (lower bytes)

ELECTRICAL**BUS****General**

Variable	Power plant measure [2110]
Unit	-
Init value	0
List	0: CAN bus 1: CT
Description	0 : The bus power is calculated by summing the generator powers (CAN bus) / 1 : The bus power is calculated using the current inputs (CT)

Variable	Nominal active power [2111]
Unit	kW
Init value	1000
Min value	1
Max value	32500
Description	This setpoint adjusts the kW nominal power of the power plant

Variable	Nominal reactive power [2112]
Unit	kVAR
Init value	730
Min value	1
Max value	32500
Description	This setpoint adjusts the kVAR nominal power of the power plant

OPERATOR MANUAL

Variable	Nominal voltage [2102]
Unit	V
Init value	400
Min value	0
Max value	65535
Description	<p>This parameter is used to set the nominal voltage:</p> <ul style="list-style-type: none"> - Three-phase and two-phase: Enter a phase-to-phase voltage. - Single-phase: Enter a phase-to-neutral voltage. <p>All the protections based on the voltage as well as the control loops are calculated as a percentage of this value.</p> <p>For low voltage (400VAC, 440VAC, 480VAC, etc...) or high voltage (20.000VAC, 33.000VAC, etc...) applications, this variable must be adjusted.</p>

Variable	Nominal frequency [2153]
Unit	Hz
Init value	50.00
Min value	0.00
Max value	100.00
Description	<p>This parameter is used to set the nominal frequency.</p> <p>All the protections based on the frequency as well as the control loops are calculated as a percentage of this value.</p> <p>For 50 or 60 Hz applications, this variable must be adjusted.</p>

Variable	PT ratio [2100]
Unit	-
Init value	1.00
Min value	0.00
Max value	655.35
Description	<p>This parameter allows you to set the ratio between the voltage present on the busbar and the voltage connected to the module.</p> <p>Example: Busbar voltage 20.000Vac / Voltage connected to the module 100 Vac: PT ratio value = $20.000/100 = 200$.</p> <p>This PT ratio can be calculated or is indicated on the measuring transformers.</p>

OPERATOR MANUAL

Variable	CT ratio [2101]
Unit	-
Init value	200.0
Min value	0.0
Max value	6553.5
Description	<p>This parameter is used to set the ratio between the current on the busbar and the current connected to the module.</p> <p>Example: Busbar current 1000A / Current connected to the module 5A: CT ratio value = $1000/5 = 200$.</p> <p>This CT ratio can be calculated or is indicated on the measuring current transformers.</p>

Variable	Power plant minimum kW [2108]
Unit	kW
Init value	0
Min value	0
Max value	32500
Description	Minimum active nominal power needed to consider the power plant ready

Variable	Power plant minimum number of GE [2109]
Unit	-
Init value	1
Min value	0
Max value	32
Description	<p>This parameter defines the minimum number of generators required to consider the power plant ready.</p> <p>The controller will close the bus breaker as soon as the number of generators on the bus is greater than or equal to the value set in this parameter.</p> <p>To magnetize the transformer, set this parameter to 0 (to close the bus breaker before the generator breakers) and configure the GENSYS COMPACT PRIME in static paralleling.</p>

OPERATOR MANUAL

Variable	Low kW active power threshold [2866]
Unit	%
Init value	5.0
Min value	0.0
Max value	100.0
Description	<p>This parameter allows you to define the minimum active power that the automatic system will impose on the generator.</p> <p>For example, this is the power that will be taken just after the circuit breaker is closed, before the load ramp.</p> <p>It is also the value at which the automatic system will open the circuit breaker during an unload ramp.</p> <p>This low limit protects against the risk of reverse power.</p> <p>It is recommended to set a low limit between 5 and 10% of the nominal active power.</p>

Variable	High kW active power threshold [2867]
Unit	%
Init value	95.0
Min value	0.0
Max value	100.0
Description	<p>This parameter allows you to define the maximum active power that the automatic system will impose on the generator when paralleled to the mains.</p> <p>In the case of a permanent mode with peak shaving, if the generator/power plant reaches the high limit, the mains will take the excess load and the peak shaving setpoint will not be respected.</p> <p>It is recommended to set a high limit between 90 and 100% of the nominal active power.</p>

Control

Variable	Base load Generator(s) kW setpoint [2107]
Unit	kW
Init value	100
Min value	0
Max value	32500
Description	<p>This parameter is used to set the active power setpoint of the generator/power plant when the product is configured in base load mode.</p>

OPERATOR MANUAL

Variable	Power factor setpoint (inductive) [2253]
Unit	-
Init value	0.80
Min value	0.00
Max value	1.00
Description	This parameter is used to set the generator/power plant $\cos(\varphi)$ set point that will be applied when paralleling to the mains. The imposed $\cos(\varphi)$ is an inductive $\cos(\varphi)$.

MAINS

General

Variable	Mains kW measure type [2155]
Unit	-
Init value	0
List	0: CT 1: mA - Analog 1 2: mA - Analog 2 3: mA - Analog 3 4: Unused
Description	This parameter is used to determine how the mains active power will be measured. 5 values can be selected: - CT : The mains power will be measured with a current transformer. Earth fault protection not available. - mA - Analog 1 : The mains power will be measured with a 4-20mA converter signal connected to analog input 1. Earth fault protection available. - mA - Analog 2: The mains power will be measured with a 4-20mA converter signal connected to analog input 2. Earth fault protection available. - mA - Analog 3: The mains power will be measured with a 4-20mA converter signal connected to analog input 3. Earth fault protection available. - Not used: No measurement of mains active power. Earth fault protection available.

Variable	Nominal voltage [2152]
Unit	V
Init value	400
Min value	0
Max value	65535
Description	This parameter is used to set the nominal voltage: - Three-phase and two-phase: Enter a phase-to-phase voltage. - Single-phase: Enter a phase-to-neutral voltage. All the protections based on the voltage are calculated as a percentage of this value. For low voltage (400VAC, 440VAC, 480VAC, etc...) or high voltage (20.000VAC, 33.000VAC, etc...) applications, this variable must be adjusted.

OPERATOR MANUAL

Variable	Nominal frequency [2153]
Unit	Hz
Init value	50.00
Min value	0.00
Max value	100.00
Description	<p>This parameter is used to set the nominal frequency.</p> <p>All the protections based on the frequency as well as the control loops are calculated as a percentage of this value.</p> <p>For 50 or 60 Hz applications, this variable must be adjusted.</p>

Variable	PT ratio [2150]
Unit	-
Init value	1.00
Min value	0.00
Max value	655.35
Description	<p>This parameter allows you to set the ratio between the voltage present on the busbar and the voltage connected to the module.</p> <p>Example: Busbar voltage 20.000Vac / Voltage connected to the module 100 Vac: PT ratio value = $20.000/100 = 200$.</p> <p>This PT ratio can be calculated or is indicated on the measuring transformers.</p>

Variable	CT ratio [2151]
Unit	-
Init value	200.0
Min value	0.0
Max value	6553.5
Description	<p>This parameter is used to set the ratio between the current on the busbar and the current connected to the module.</p> <p>Example: Busbar current 1000A / Current connected to the module 5A: CT ratio value = $1000/5 = 200$.</p> <p>This CT ratio can be calculated or is indicated on the measuring current transformers.</p>

Variable	External MCB low kW trip [2156]
Unit	-
Init value	0
List	0: No 1: Yes
Description	This parameter is used to enable opening of the mains breaker on an external active power low threshold. When this parameter is enabled, the automated system will not open the mains breaker when the value of the mains active power reaches 0, but will wait for the digital input configured as 'External mains low threshold' to activate. This function can be used with an external device that measures the 3 mains currents and provides a digital output that is activated when the 3 currents are 0A.

Setpoint

Variable	Peak shaving kW setpoint [2154]
Unit	kW
Init value	100
Min value	-32768
Max value	32767
Description	This parameter is used to set the active power setpoint of the mains when the product is configured in peak shaving mode.

Variable	Limit inverter power export [2159]
Unit	-
Init value	0
List	0: No 1: Yes
Description	Limit the export of the power generated by the inverter to the mains.

SYNCHRONISATION CHECK

Variable	Voltage acceptance [2800]
Unit	%
Init value	5.0
Min value	0.0
Max value	12.0
Description	Maximum voltage difference (in % of the nominal value) between the voltages on either side of the circuit breaker to allow closing.

Variable	Frequency acceptance [2801]
Unit	Hz
Init value	0.10
Min value	0.00
Max value	0.20
Description	Maximum frequency difference between the voltages on either side of the circuit breaker to allow closing.

Variable	Phase Angle acceptance [2802]
Unit	°
Init value	10
Min value	0
Max value	30
Description	Maximum phase difference between the voltages on either side of the circuit breaker to allow closing.

Variable	Fail to synchronize timer [2803]
Unit	s
Init value	120.0
Min value	0.0
Max value	999.9
Description	Time after which the product will activate an alarm if it remains in synchronization without ever being able to give the closing command. Activation of this alarm means that the synchronization control loops are incorrectly set.

OPERATOR MANUAL

Variable	Action on fail to synchronize [2804]
Unit	-
Init value	3
List	0: Unused 3: Alarm 4: Fault (soft shutdown)
Description	Action performed on protection's trigger. Actions' description is available in the technical documentation.

Variable	Phase offset [2812]
Unit	°
Init value	0
Min value	-180
Max value	180
Description	Phase offset for synch. check relay (Ex: Dyn11)

POWER MANAGEMENT

Load shedding

Variable	Opening load on under frequency [3702]
Unit	-
Init value	0
List	0: Disabled 1: Enable
Description	Enables/Disables underfrequency monitoring for non-essential load shedding

Variable	Under frequency threshold 1 [3700]
Unit	%
Init value	96.0
Min value	0.0
Max value	100.0
Description	First underfrequency level

Variable	Under frequency threshold 2 [3701]
Unit	%
Init value	90.0
Min value	0.0
Max value	100.0
Description	Second underfrequency level (must be lower than level 1)

Variable	Opening of the load on maximum kW [3705]
Unit	-
Init value	0
List	0: Disabled 1: Enable
Description	Enables/Disables overload monitoring for non-essential load shedding

OPERATOR MANUAL

Variable	Maximum kW threshold 1 [3703]
Unit	%
Init value	95.0
Min value	0.0
Max value	200.0
Description	First overload level

Variable	Maximum KW threshold 2 [3704]
Unit	%
Init value	100.0
Min value	0.0
Max value	200.0
Description	Second overload level (must be higher than level 1)

Variable	Timer for threshold 1 [3706]
Unit	s
Init value	6.0
Min value	0.0
Max value	999.9
Description	Delay before first level activation (kW and Hz)

Variable	Timer for threshold 2 [3707]
Unit	s
Init value	2.0
Min value	0.0
Max value	999.9
Description	Delay before activation of the second level (kW and Hz). Must be lower than level 1.

Variable	Minimum delay between 2 openings [2861]
Unit	s
Init value	5.0
Min value	0.0
Max value	999.9
Description	Minimum time between two load shedding requests

Variable	Action after last opening [2862]
Unit	-
Init value	0
List	0: Unused 3: Alarm 4: Fault (soft shutdown)
Description	Action performed on protection's trigger. Actions' description is available in the technical documentation.

Unload breakers

Enable/disable unload breakers

Variable	Enable unload breakers [3730]
Unit	-
Init value	0
List	0: No 1: Yes
Description	Enable unload breakers

Unload breaker 1

Variable	Unload breaker kW 1 [3731]
Unit	kW
Init value	0
Min value	0
Max value	32500
Description	Active power threshold before closing the breaker of the load n°1

Variable	Unload breaker timer 1 [3720]
Unit	s
Init value	0.0
Min value	0.0
Max value	999.9
Description	Time before closing the breaker of the load n°1

Unload breaker 2

Variable	Unload breaker kW 2 [3732]
Unit	kW
Init value	0
Min value	0
Max value	32500
Description	Active power threshold before closing the breaker of the load n°2

Variable	Unload breaker timer 2 [3721]
Unit	s
Init value	0.0
Min value	0.0
Max value	999.9
Description	Time before closing the breaker of the load n°2

Unload breaker 3

Variable	Unload breaker kW 3 [3733]
Unit	kW
Init value	0
Min value	0
Max value	32500
Description	Active power threshold before closing the breaker of the load n°3

Variable	Unload breaker timer 3 [3722]
Unit	s
Init value	0.0
Min value	0.0
Max value	999.9
Description	Time before closing the breaker of the load n°3

Unload breaker 4

Variable	Unload breaker kW 4 [3734]
Unit	kW
Init value	0
Min value	0
Max value	32500
Description	Active power threshold before closing the breaker of the load n°4

Variable	Unload breaker timer 4 [3723]
Unit	s
Init value	0.0
Min value	0.0
Max value	999.9
Description	Time before closing the breaker of the load n°4

Unload breaker 5

Variable	Unload breaker kW 5 [3735]
Unit	kW
Init value	0
Min value	0
Max value	32500
Description	Active power threshold before closing the breaker of the load n°5

Variable	Unload breaker timer 5 [3724]
Unit	s
Init value	0.0
Min value	0.0
Max value	999.9
Description	Time before closing the breaker of the load n°5

Unload breaker 6

Variable	Unload breaker kW 6 [3736]
Unit	kW
Init value	0
Min value	0
Max value	32500
Description	Active power threshold before closing the breaker of the load n°6

Variable	Unload breaker timer 6 [3725]
Unit	s
Init value	0.0
Min value	0.0
Max value	999.9
Description	Time before closing the breaker of the load n°6

Unload breaker 7

Variable	Unload breaker kW 7 [3737]
Unit	kW
Init value	0
Min value	0
Max value	32500
Description	Active power threshold before closing the breaker of the load n°7

Variable	Unload breaker timer 7 [3726]
Unit	s
Init value	0.0
Min value	0.0
Max value	999.9
Description	Time before closing the breaker of the load n°7

Unload breaker 8

Variable	Unload breaker kW 8 [3738]
Unit	kW
Init value	0
Min value	0
Max value	32500
Description	Active power threshold before closing the breaker of the load n°8

Variable	Unload breaker timer 8 [3727]
Unit	s
Init value	0.0
Min value	0.0
Max value	999.9
Description	Time before closing the breaker of the load n°8

Unload breaker 9

Variable	Unload breaker kW 9 [3739]
Unit	kW
Init value	0
Min value	0
Max value	32500
Description	Active power threshold before closing the breaker of the load n°9

Variable	Unload breaker timer 9 [3728]
Unit	s
Init value	0.0
Min value	0.0
Max value	999.9
Description	Time before closing the breaker of the load n°9

Unload breaker 10

Variable	Unload breaker kW 10 [3740]
Unit	kW
Init value	0
Min value	0
Max value	32500
Description	Active power threshold before closing the breaker of the load n°10

Variable	Unload breaker timer 10 [3729]
Unit	s
Init value	0.0
Min value	0.0
Max value	999.9
Description	Time before closing the breaker of the load n°10

INPUTS/OUTPUTS

DIGITAL INPUTS

Digital inputs

Input 1 (Customisable) [250]

Variable	Function configured on DI 1 [2700]
Unit	-
Init value	4501
Min value	0
Max value	10299
Description	Digital Input 1 associated function (Default value: Generator breaker feedback)

Variable	Polarity NO/NC on DI 1 [2736]
Unit	-
Init value	0
Min value	0
Max value	1
Description	Direction of Digital Input 1 (0=Normaly Open/1=Normaly Close)

Variable	Validity on digital input 1 [2727]
Unit	-
Init value	1
Min value	0
Max value	3
Description	Digital Input 1 activation validity (0=Never/1=Always/2=Post Starting/3= rpm & Volt Stabilized)

Variable	Timer ON Digital Input 1 [2709]
Unit	s
Init value	0.0
Min value	0.0
Max value	6553.5
Description	Digital Input 1 activation timer

Variable	Timer OFF Digital Input 1 [2718]
Unit	s
Init value	0.0
Min value	0.0
Max value	6553.5
Description	Digital Input 1 desactivation timer

Input 2 (Customisable) [251]

Variable	Function configured on DI 2 [2701]
Unit	-
Init value	4502
Min value	0
Max value	10299
Description	Digital Input 2 associated function (Default value: Remote start)

Variable	Polarity NO/NC on DI 2 [2737]
Unit	-
Init value	0
Min value	0
Max value	1
Description	Direction of Digital Input 2 (0=Normaly Open/1=Normaly Close)

Variable	Validity on digital input 2 [2728]
Unit	-
Init value	1
Min value	0
Max value	3
Description	Digital Input 2 activation validity (0=Never/1=Always/2=Post Starting/3= rpm & Volt Stabilized)

Variable	Timer ON Digital Input 2 [2710]
Unit	s
Init value	0.0
Min value	0.0
Max value	6553.5
Description	Digital Input 2 activation timer

Variable	Timer OFF Digital Input 2 [2719]
Unit	s
Init value	0.0
Min value	0.0
Max value	6553.5
Description	Digital Input 2 desactivation timer

Input 3 (Customisable) [252]

Variable	Function configured on DI 3 [2702]
Unit	-
Init value	4505
Min value	0
Max value	10299
Description	Digital Input 3 associated function (Default value: Emergency stop)

Variable	Polarity NO/NC on DI 3 [2738]
Unit	-
Init value	1
Min value	0
Max value	1
Description	Direction of Digital Input 3 (0=Normaly Open/1=Normaly Close)

Variable	Validity on digital input 3 [2729]
Unit	-
Init value	1
Min value	0
Max value	3
Description	Digital Input 3 activation validity (0=Never/1=Always/2=Post Starting/3= rpm & Volt Stabilized)

Variable	Timer ON Digital Input 3 [2711]
Unit	s
Init value	0.0
Min value	0.0
Max value	6553.5
Description	Digital Input 3 activation timer

Variable	Timer OFF Digital Input 3 [2720]
Unit	s
Init value	0.0
Min value	0.0
Max value	6553.5
Description	Digital Input 3 desactivation timer

Input 4 (Customisable) [253]

Variable	Function configured on DI 4 [2703]
Unit	-
Init value	4500
Min value	0
Max value	10299
Description	Digital Input 4 associated function (Default value: Mains breaker feedback on COMPACT MAINS)

OPERATOR MANUAL

Variable	Polarity NO/NC on DI 4 [2739]
Unit	-
Init value	0
Min value	0
Max value	1
Description	Direction of Digital Input 4 (0=Normaly Open/1=Normaly Close)

Variable	Validity on digital input 4 [2730]
Unit	-
Init value	1
Min value	0
Max value	3
Description	Digital Input 4 activation validity (0=Never/1=Always/2=Post Starting/3= rpm & Volt Stabilized)

Variable	Timer ON Digital Input 4 [2712]
Unit	s
Init value	0.0
Min value	0.0
Max value	6553.5
Description	Digital Input 4 activation timer

Variable	Timer OFF Digital Input 4 [2721]
Unit	s
Init value	0.0
Min value	0.0
Max value	6553.5
Description	Digital Input 4 desactivation timer

Input 5 (Customisable) [254]

Variable	Function configured on DI 5 [2704]
Unit	-
Init value	0
Min value	0
Max value	10299
Description	Digital Input 5 associated function

Variable	Polarity NO/NC on DI 5 [2740]
Unit	-
Init value	0
Min value	0
Max value	1
Description	Direction of Digital Input 5 (0=Normaly Open/1=Normaly Close)

Variable	Validity on digital input 5 [2731]
Unit	-
Init value	1
Min value	0
Max value	3
Description	Digital Input 5 activation validity (0=Never/1=Always/2=Post Starting/3= rpm & Volt Stabilized)

Variable	Timer ON Digital Input 5 [2713]
Unit	s
Init value	0.0
Min value	0.0
Max value	6553.5
Description	Digital Input 5 activation timer

Variable	Timer OFF Digital Input 5 [2722]
Unit	s
Init value	0.0
Min value	0.0
Max value	6553.5
Description	Digital Input 5 desactivation timer

Input 6 (Customisable) [255]

Variable	Function configured on DI 6 [2705]
Unit	-
Init value	0
Min value	0
Max value	10299
Description	Digital Input 6 associated function

Variable	Polarity NO/NC on DI 6 [2741]
Unit	-
Init value	0
Min value	0
Max value	1
Description	Direction of Digital Input 6 (0=Normaly Open/1=Normaly Close)

Variable	Validity on digital input 6 [2732]
Unit	-
Init value	1
Min value	0
Max value	3
Description	Digital Input 6 activation validity (0=Never/1=Always/2=Post Starting/3= rpm & Volt Stabilized)

Variable	Timer ON Digital Input 6 [2714]
Unit	s
Init value	0.0
Min value	0.0
Max value	6553.5
Description	Digital Input 6 activation timer

Variable	Timer OFF Digital Input 6 [2723]
Unit	s
Init value	0.0
Min value	0.0
Max value	6553.5
Description	Digital Input 6 desactivation timer

Input 7 (Customisable) [256]

Variable	Function configured on DI 7 [2706]
Unit	-
Init value	0
Min value	0
Max value	10299
Description	Digital Input 7 associated function

Variable	Polarity NO/NC on DI 7 [2742]
Unit	-
Init value	0
Min value	0
Max value	1
Description	Direction of Digital Input 7 (0=Normaly Open/1=Normaly Close)

Variable	Validity on digital input 7 [2733]
Unit	-
Init value	1
Min value	0
Max value	3
Description	Digital Input 7 activation validity (0=Never/1=Always/2=Post Starting/3= rpm & Volt Stabilized)

Variable	Timer ON Digital Input 7 [2715]
Unit	s
Init value	0.0
Min value	0.0
Max value	6553.5
Description	Digital Input 7 activation timer

Variable	Timer OFF Digital Input 7 [2724]
Unit	s
Init value	0.0
Min value	0.0
Max value	6553.5
Description	Digital Input 7 desactivation timer

Input 8 (Customisable) [257]

Variable	Function configured on DI 8 [2707]
Unit	-
Init value	0
Min value	0
Max value	10299
Description	Digital Input 8 associated function

OPERATOR MANUAL

Variable	Polarity NO/NC on DI 8 [2743]
Unit	-
Init value	0
Min value	0
Max value	1
Description	Direction of Digital Input 8 (0=Normaly Open/1=Normaly Close)

Variable	Validity on digital input 8 [2734]
Unit	-
Init value	1
Min value	0
Max value	3
Description	Digital Input 8 activation validity (0=Never/1=Always/2=Post Starting/3= rpm & Volt Stabilized)

Variable	Timer ON Digital Input 8 [2716]
Unit	s
Init value	0.0
Min value	0.0
Max value	6553.5
Description	Digital Input 8 activation timer

Variable	Timer OFF Digital Input 8 [2725]
Unit	s
Init value	0.0
Min value	0.0
Max value	6553.5
Description	Digital Input 8 desactivation timer

Input 9 (Customisable) [258]

Variable	Function configured on DI 9 [2708]
Unit	-
Init value	0
Min value	0
Max value	10299
Description	Digital Input 9 associated function

Variable	Polarity NO/NC on DI 9 [2744]
Unit	-
Init value	0
Min value	0
Max value	1
Description	Direction of Digital Input 9 (0=Normaly Open/1=Normaly Close)

Variable	Validity on digital input 9 [2735]
Unit	-
Init value	1
Min value	0
Max value	3
Description	Digital Input 9 activation validity (0=Never/1=Always/2=Post Starting/3= rpm & Volt Stabilized)

Variable	Timer ON Digital Input 9 [2717]
Unit	s
Init value	0.0
Min value	0.0
Max value	6553.5
Description	Digital Input 9 activation timer

Variable	Timer OFF Digital Input 9 [2726]
Unit	s
Init value	0.0
Min value	0.0
Max value	6553.5
Description	Digital Input 9 desactivation timer

Hysteresis on digital input

Hysteresis on digital input 1

Variable	Hysteresis 1 enable for digital input [2769]
Unit	-
Init value	0
List	0: No 1: Yes
Description	<p>This parameter enables the first hysteresis function on logic threshold to be activated.</p> <p>To do this:</p> <ul style="list-style-type: none"> - Configure a digital input as 'Hysteresis low threshold DI1' and wire the hysteresis low threshold logic signal to this input. - Configure a digital input as 'Hysteresis high threshold DI1' and wire the hysteresis high threshold logic signal to this input. - Configure a digital output as 'Hysteresis output activation on DI1' and wire this output to the hysteresis control - Select the direction of activation/deactivation of the control

Variable	Timer ON hysteresis 1 [2777]
Unit	s
Init value	0.0
Min value	0.0
Max value	999.9
Description	This parameter allows to set the time between the moment when the activation threshold is reached and the moment when the command is activated.

Variable	Direction hysteresis 1 [2785]
Unit	-
Init value	0
List	0: Set on low threshold, reset on high threshold 1: Set on high threshold, reset on low threshold
Description	This parameter allows to set the direction in which the hysteresis should work. 2 choices are possible: - Activate the command when the low threshold is active and deactivate it when the high threshold is active - Activate the command when the high threshold is active and deactivate it when the low threshold is active

Hysteresis on digital input 2

Variable	Hysteresis 2 enable for digital input [2770]
Unit	-
Init value	0
List	0: No 1: Yes
Description	This parameter enables the second hysteresis function on logic threshold to be activated. To do this: - Configure a digital input as 'Hysteresis low threshold DI2' and wire the hysteresis low threshold logic signal to this input. - Configure a digital input as 'Hysteresis high threshold DI2' and wire the hysteresis high threshold logic signal to this input. - Configure a digital output as 'Hysteresis output activation on DI2' and wire this output to the hysteresis control - Select the direction of activation/deactivation of the control

Variable	Timer ON hysteresis 2 [2778]
Unit	s
Init value	0.0
Min value	0.0
Max value	999.9
Description	This parameter allows to set the time between the moment when the activation threshold is reached and the moment when the command is activated.

Variable	Direction hysteresis 2 [2786]
Unit	-
Init value	0
List	0: Set on low threshold, reset on high threshold 1: Set on high threshold, reset on low threshold
Description	This parameter allows to set the direction in which the hysteresis should work. 2 choices are possible: - Activate the command when the low threshold is active and deactivate it when the high threshold is active - Activate the command when the high threshold is active and deactivate it when the low threshold is active

Hysteresis on digital input 3

Variable	Hysteresis 3 enable for digital input [2771]
Unit	-
Init value	0
List	0: No 1: Yes
Description	This parameter enables the third hysteresis function on logic threshold to be activated. To do this: - Configure a digital input as 'Hysteresis low threshold DI3' and wire the hysteresis low threshold logic signal to this input. - Configure a digital input as 'Hysteresis high threshold DI3' and wire the hysteresis high threshold logic signal to this input. - Configure a digital output as 'Hysteresis output activation on DI3' and wire this output to the hysteresis control - Select the direction of activation/deactivation of the control

Variable	Timer ON hysteresis 3 [2779]
Unit	s
Init value	0.0
Min value	0.0
Max value	999.9
Description	This parameter allows to set the time between the moment when the activation threshold is reached and the moment when the command is activated.

Variable	Direction hysteresis 3 [2787]
Unit	-
Init value	0
List	0: Set on low threshold, reset on high threshold 1: Set on high threshold, reset on low threshold
Description	This parameter allows to set the direction in which the hysteresis should work. 2 choices are possible: - Activate the command when the low threshold is active and deactivate it when the high threshold is active - Activate the command when the high threshold is active and deactivate it when the low threshold is active

Hysteresis on digital input 4

Variable	Hysteresis 4 enable for digital input [2772]
Unit	-
Init value	0
List	0: No 1: Yes
Description	This parameter enables the fourth hysteresis function on logic threshold to be activated. To do this: - Configure a digital input as 'Hysteresis low threshold DI4' and wire the hysteresis low threshold logic signal to this input. - Configure a digital input as 'Hysteresis high threshold DI4' and wire the hysteresis high threshold logic signal to this input. - Configure a digital output as 'Hysteresis output activation on DI4' and wire this output to the hysteresis control - Select the direction of activation/deactivation of the control

Variable	Timer ON hysteresis 4 [2780]
Unit	s
Init value	0.0
Min value	0.0
Max value	999.9
Description	This parameter allows to set the time between the moment when the activation threshold is reached and the moment when the command is activated.

Variable	Direction hysteresis 4 [2788]
Unit	-
Init value	0
List	0: Set on low threshold, reset on high threshold 1: Set on high threshold, reset on low threshold
Description	This parameter allows to set the direction in which the hysteresis should work. 2 choices are possible: - Activate the command when the low threshold is active and deactivate it when the high threshold is active - Activate the command when the high threshold is active and deactivate it when the low threshold is active

Hysteresis on digital input 5

Variable	Hysteresis 5 enable for digital input [2773]
Unit	-
Init value	0
List	0: No 1: Yes
Description	This parameter enables the fifth hysteresis function on logic threshold to be activated. To do this: - Configure a digital input as 'Hysteresis low threshold DI5' and wire the hysteresis low threshold logic signal to this input. - Configure a digital input as 'Hysteresis high threshold DI5' and wire the hysteresis high threshold logic signal to this input. - Configure a digital output as 'Hysteresis output activation on DI5' and wire this output to the hysteresis control - Select the direction of activation/deactivation of the control

Variable	Timer ON hysteresis 5 [2781]
Unit	s
Init value	0.0
Min value	0.0
Max value	999.9
Description	This parameter allows to set the time between the moment when the activation threshold is reached and the moment when the command is activated.

Variable	Direction hysteresis 5 [2789]
Unit	-
Init value	0
List	0: Set on low threshold, reset on high threshold 1: Set on high threshold, reset on low threshold
Description	This parameter allows to set the direction in which the hysteresis should work. 2 choices are possible: - Activate the command when the low threshold is active and deactivate it when the high threshold is active - Activate the command when the high threshold is active and deactivate it when the low threshold is active

Hysteresis on digital input 6

Variable	Hysteresis 6 enable for digital input [2774]
Unit	-
Init value	0
List	0: No 1: Yes
Description	This parameter enables the sixth hysteresis function on logic threshold to be activated. To do this: - Configure a digital input as 'Hysteresis low threshold DI6' and wire the hysteresis low threshold logic signal to this input. - Configure a digital input as 'Hysteresis high threshold DI6' and wire the hysteresis high threshold logic signal to this input. - Configure a digital output as 'Hysteresis output activation on DI6' and wire this output to the hysteresis control - Select the direction of activation/deactivation of the control

Variable	Timer ON hysteresis 6 [2782]
Unit	s
Init value	0.0
Min value	0.0
Max value	999.9
Description	This parameter allows to set the time between the moment when the activation threshold is reached and the moment when the command is activated.

Variable	Direction hysteresis 6 [2790]
Unit	-
Init value	0
List	0: Set on low threshold, reset on high threshold 1: Set on high threshold, reset on low threshold
Description	This parameter allows to set the direction in which the hysteresis should work. 2 choices are possible: - Activate the command when the low threshold is active and deactivate it when the high threshold is active - Activate the command when the high threshold is active and deactivate it when the low threshold is active

Hysteresis on digital input 7

Variable	Hysteresis 7 enable for digital input [2775]
Unit	-
Init value	0
List	0: No 1: Yes
Description	This parameter enables the seventh hysteresis function on logic threshold to be activated. To do this: - Configure a digital input as 'Hysteresis low threshold DI7' and wire the hysteresis low threshold logic signal to this input. - Configure a digital input as 'Hysteresis high threshold DI7' and wire the hysteresis high threshold logic signal to this input. - Configure a digital output as 'Hysteresis output activation on DI7' and wire this output to the hysteresis control - Select the direction of activation/deactivation of the control

Variable	Timer ON hysteresis 7 [2783]
Unit	s
Init value	0.0
Min value	0.0
Max value	999.9
Description	This parameter allows to set the time between the moment when the activation threshold is reached and the moment when the command is activated.

Variable	Direction hysteresis 7 [2791]
Unit	-
Init value	0
List	0: Set on low threshold, reset on high threshold 1: Set on high threshold, reset on low threshold
Description	This parameter allows to set the direction in which the hysteresis should work. 2 choices are possible: - Activate the command when the low threshold is active and deactivate it when the high threshold is active - Activate the command when the high threshold is active and deactivate it when the low threshold is active

Hysteresis on digital input 8

Variable	Hysteresis 8 enable for digital input [2776]
Unit	-
Init value	0
List	0: No 1: Yes
Description	This parameter enables the eighth hysteresis function on logic threshold to be activated. To do this: - Configure a digital input as 'Hysteresis low threshold DI8' and wire the hysteresis low threshold logic signal to this input. - Configure a digital input as 'Hysteresis high threshold DI8' and wire the hysteresis high threshold logic signal to this input. - Configure a digital output as 'Hysteresis output activation on DI8' and wire this output to the hysteresis control - Select the direction of activation/deactivation of the control

Variable	Timer ON hysteresis 8 [2784]
Unit	s
Init value	0.0
Min value	0.0
Max value	999.9
Description	This parameter allows to set the time between the moment when the activation threshold is reached and the moment when the command is activated.

OPERATOR MANUAL

Variable	Direction hysteresis 8 [2792]
Unit	-
Init value	0
List	0: Set on low threshold, reset on high threshold 1: Set on high threshold, reset on low threshold
Description	This parameter allows to set the direction in which the hysteresis should work. 2 choices are possible: - Activate the command when the low threshold is active and deactivate it when the high threshold is active - Activate the command when the high threshold is active and deactivate it when the low threshold is active

DIGITAL/RELAYS OUTPUTS

Digital outputs

Output 1 (Customisable) [4350]

Variable	Function configured DO 1 [2745]
Unit	-
Init value	4676
Min value	0
Max value	10299
Description	Output 1 Associated function

Variable	Polarity NE/ND DO 1 [2751]
Unit	-
Init value	0
Min value	0
Max value	1
Description	Polarity (0=Normaly De-energized / 1=Normaly Energized) Digital output 1

Variable	Pulse length DO 1 [2761]
Unit	s
Init value	0.0
Min value	0.0
Max value	6553.5
Description	Digital ouput 1 pulse timer (0 = no pulse, continous activation)

Variable	Activation delay DO 01 [2793]
Unit	s
Init value	0.0
Min value	0.0
Max value	6553.5
Description	Delay before physical activation of logic output 1

Output 2 (Customisable) [4351]

Variable	Function configured DO 2 [2746]
Unit	-
Init value	4678
Min value	0
Max value	10299
Description	Output 2 Associated function

Variable	Polarity NE/ND DO 2 [2752]
Unit	-
Init value	0
Min value	0
Max value	1
Description	Polarity (0=Normaly De-energized / 1=Normaly Energized) Digital output 2

Variable	Pulse length DO 2 [2762]
Unit	s
Init value	0.0
Min value	0.0
Max value	6553.5
Description	Digital ouput 2 pulse timer (0 = no pulse, continous activation)

Variable	Activation delay DO 02 [2794]
Unit	s
Init value	0.0
Min value	0.0
Max value	6553.5
Description	Delay before physical activation of logic output 2

Output 3 (Customisable) [4352]

Variable	Function configured DO 3 [2747]
Unit	-
Init value	0
Min value	0
Max value	10299
Description	Output 3 Associated function

Variable	Polarity NE/ND DO 3 [2753]
Unit	-
Init value	0
Min value	0
Max value	1
Description	Polarity (0=Normaly De-energized / 1=Normaly Energized) Digital output 3

Variable	Pulse length DO 3 [2763]
Unit	s
Init value	0.0
Min value	0.0
Max value	6553.5
Description	Digital ouput 3 pulse timer (0 = no pulse, continous activation)

Variable	Activation delay DO 03 [2795]
Unit	s
Init value	0.0
Min value	0.0
Max value	6553.5
Description	Delay before physical activation of logic output 3

Output 4 (Customisable) [4353]

Variable	Function configured DO 4 [2748]
Unit	-
Init value	0
Min value	0
Max value	10299
Description	Output 4 Associated function

Variable	Polarity NE/ND DO 4 [2754]
Unit	-
Init value	0
Min value	0
Max value	1
Description	Polarity (0=Normaly De-energized / 1=Normaly Energized) Digital output 4

Variable	Pulse length DO 4 [2764]
Unit	s
Init value	0.0
Min value	0.0
Max value	6553.5
Description	Digital ouput 4 pulse timer (0 = no pulse, continous activation)

Variable	Activation delay DO 04 [2796]
Unit	s
Init value	0.0
Min value	0.0
Max value	6553.5
Description	Delay before physical activation of logic output 4

Output 5 (Customisable) [4354]

Variable	Function configured DO 5 [2749]
Unit	-
Init value	0
Min value	0
Max value	10299
Description	Output 5 Associated function

Variable	Polarity NE/ND DO 5 [2755]
Unit	-
Init value	0
Min value	0
Max value	1
Description	Polarity (0=Normaly De-energized / 1=Normaly Energized) Digital output 5

Variable	Pulse length DO 5 [2765]
Unit	s
Init value	0.0
Min value	0.0
Max value	6553.5
Description	Digital ouput 5 pulse timer (0 = no pulse, continous activation)

Variable	Activation delay DO 05 [2797]
Unit	s
Init value	0.0
Min value	0.0
Max value	6553.5
Description	Delay before physical activation of logic output 5

Output 6 (Customisable) [4355]

Variable	Function configured DO 6 [2750]
Unit	-
Init value	0
Min value	0
Max value	10299
Description	Output 6 Associated function

Variable	Polarity NE/ND DO 6 [2756]
Unit	-
Init value	0
Min value	0
Max value	1
Description	Polarity (0=Normaly De-energized / 1=Normaly Energized) Digital output 6

Variable	Pulse length DO 6 [2766]
Unit	s
Init value	0.0
Min value	0.0
Max value	6553.5
Description	Digital ouput 6 pulse timer (0 = no pulse, continous activation)

Variable	Activation delay DO 06 [2798]
Unit	s
Init value	0.0
Min value	0.0
Max value	6553.5
Description	Delay before physical activation of logic output 6

Relay outputs

Relay 1 (Customisable) [4356]

Variable	Output function Relay 1 [2757]
Unit	-
Init value	4677
Min value	0
Max value	10299
Description	Relay 1 Associated function

Variable	Direction NO/NC Relay 1 [2759]
Unit	-
Init value	0
Min value	0
Max value	1
Description	Relay 1 Direction (0=Normaly Open / 1=Normaly Closed)

Variable	Pulse length R 1 [2767]
Unit	s
Init value	0.0
Min value	0.0
Max value	6553.5
Description	Relay ouput 1 pulse timer (0 = no pulse, continous activation)

Variable	Activation delay relay 1 [8250]
Unit	s
Init value	0.0
Min value	0.0
Max value	6553.5
Description	Delay before physical activation of relay 1

Relay 2 (Customisable) [4357]

Variable	Output function Relay 2 [2758]
Unit	-
Init value	4675
Min value	0
Max value	10299
Description	Relay 2 Associated function

Variable	Direction NO/NC Relay 2 [2760]
Unit	-
Init value	0
Min value	0
Max value	1
Description	Relay 2 Direction (0=Normaly Open / 1=Normaly Closed)

Variable	Pulse length R 2 [2768]
Unit	s
Init value	0.0
Min value	0.0
Max value	6553.5
Description	Relay ouput 2 pulse timer (0 = no pulse, continous activation)

Variable	Activation delay relay 2 [8251]
Unit	s
Init value	0.0
Min value	0.0
Max value	6553.5
Description	Delay before physical activation of relay 2

BREAKER

General

Variable	Synchronization back timer [2806]
Unit	s
Init value	30.0
Min value	0.0
Max value	999.9
Description	This setpoint adjusts the synchronization back timer. It sets the time to wait to start again a synchronization sequence after a 'bus electrical fault' protection.

Variable	Fail to open/close breaker timer [2304]
Unit	s
Init value	5.0
Min value	0.1
Max value	10.0
Description	Circuit breaker max command delay (timer for discrepancy between command and feedback), identical for both generator circuit breaker and main circuit breaker, is generating a fault.

Variable	Unexpected close/open breaker timer [2317]
Unit	s
Init value	1.0
Min value	0.0
Max value	10.0
Description	Timer before taking into account an unexpected change of a breaker feedback input state.

Bus breaker

Attempts number

Variable	Synchronization Back attempts number [2807]
Unit	-
Init value	3
Min value	0
Max value	15
Description	This setpoint adjusts the synchronization back attempts number. It sets the attempts number to start again a synchronization of the bus after a 'bus electrical fault' protection.

Control

Variable	Bus circuit breaker control type [2300]
Unit	-
Init value	4
List	0: Open Contact - Close Pulse 1: Open Contact - Close Contact 2: Open MNcoil - Close Pulse 3: Open MNcoil - Close Contact 4: Open Pulse - Close Pulse 5: Open Pulse - Close Contact
Description	Control type of the relay for the genset circuit breaker of the genset (pulse, hold, coil...)

Pulse

Variable	Bus breaker control pulse length [2301]
Unit	s
Init value	2.5
Min value	0.1
Max value	10.0
Description	Bus circuit breaker pulse length

Variable	Undervoltage coil deenergized time [2302]
Unit	s
Init value	1.0
Min value	0.1
Max value	10.0
Description	Time during which the coil is no longer energized after a request to open the circuit breaker.

Variable	Undervoltage coil security timer [2303]
Unit	s
Init value	2.0
Min value	0.1
Max value	10.0
Description	Minimum safety time between the moment the coil has been reenergized and the next request to close the circuit breaker.

Mains breaker

Attempts number

Variable	Synchronization Back attempts number [2814]
Unit	-
Init value	3
Min value	0
Max value	15
Description	This setpoint adjusts the synchronization back attempts number. It sets the attempts number to start again a synchronization of the bus after a "mains electrical fault" protection.

Control

Variable	Mains circuit breaker control type [2307]
Unit	-
Init value	4
List	0: Open Contact - Close Pulse 1: Open Contact - Close Contact 2: Open MNcoil - Close Pulse 3: Open MNcoil - Close Contact 4: Open Pulse - Close Pulse 5: Open Pulse - Close Contact
Description	Control type of the relay for the Mains circuit breaker of the genset (pulse, hold, coil...)

Pulse

Variable	Mains breaker control pulse length [2314]
Unit	s
Init value	2.5
Min value	0.1
Max value	10.0
Description	Mains circuit breaker pulse length

Variable	Undervoltage coil deenergized time [2315]
Unit	s
Init value	1.0
Min value	0.1
Max value	10.0
Description	Time during which the coil is no longer energized after a request to open the circuit breaker.

Variable	Undervoltage coil security timer [2316]
Unit	s
Init value	2.0
Min value	0.1
Max value	10.0
Description	Minimum safety time between the moment the coil has been reenergized and the next request to close the circuit breaker.

Mains failure

Variable	Mains breaker tripping mode on mains failure [2312]
Unit	-
Init value	2
List	0: Immediately 2: After power plant ready 3: After timer
Description	Mains breaker opening mode on Mains electrical fault (0: Immediately/1:After start/2:After power plant ready/3:After timer)

Variable	Timer to open mains breaker on mains failure [2313]
Unit	s
Init value	1.0
Min value	0.0
Max value	999.9
Description	Delay before MCB open command on fault if E2312 = 3

CANOPEN

Digital inputs

CANopen DI 1 (Customisable) [800]

Variable	CANopenFuncI1 [3200]
Unit	-
Init value	0
Min value	0
Max value	10299
Description	selection of the function, which will be executed when the logic input changes state . (see functions on logic inputs for more details about functions)

Variable	CANopenDir I1 [3296]
Unit	-
Init value	0
Min value	0
Max value	1
Description	Direction of logic input Normally open or Normally closed

Variable	Validity on CANopen digital input 1 [3264]
Unit	-
Init value	1
Min value	0
Max value	3
Description	Activation validity (0=Never/1=Always/2=Post Starting/3= rpm & Volt Stabilized)

Variable	CANopenTM I1 [3232]
Unit	s
Init value	0.0
Min value	0.0
Max value	6553.5
Description	Function execution delay, user can add execution delay after logic input status change

CANopen DI 2 (Customisable) [801]

Variable	CANopenFuncI2 [3201]
Unit	-
Init value	0
Min value	0
Max value	10299
Description	selection of the function, which will be executed when the logic input changes state . (see functions on logic inputs for more details about functions)

Variable	CANopenDir I2 [3297]
Unit	-
Init value	0
Min value	0
Max value	1
Description	Direction of logic input Normally open or Normally closed

Variable	Validity on CANopen digital input 2 [3265]
Unit	-
Init value	1
Min value	0
Max value	3
Description	Activation validity (0=Never/1=Always/2=Post Starting/3= rpm & Volt Stabilized)

Variable	CANopenTM I2 [3233]
Unit	s
Init value	0.0
Min value	0.0
Max value	6553.5
Description	Function execution delay, user can add execution delay after logic input status change

CANopen DI 3 (Customisable) [802]

Variable	CANopenFuncI3 [3202]
Unit	-
Init value	0
Min value	0
Max value	10299
Description	selection of the function, which will be executed when the logic input changes state . (see functions on logic inputs for more details about functions)

Variable	CANopenDir I3 [3298]
Unit	-
Init value	0
Min value	0
Max value	1
Description	Direction of logic input Normally open or Normally closed

Variable	Validity on CANopen digital input 3 [3266]
Unit	-
Init value	1
Min value	0
Max value	3
Description	Activation validity (0=Never/1=Always/2=Post Starting/3= rpm & Volt Stabilized)

Variable	CANopenTM I3 [3234]
Unit	s
Init value	0.0
Min value	0.0
Max value	6553.5
Description	Function execution delay, user can add execution delay after logic input status change

CANopen DI 4 (Customisable) [803]

Variable	CANopenFuncI4 [3203]
Unit	-
Init value	0
Min value	0
Max value	10299
Description	selection of the function, which will be executed when the logic input changes state . (see functions on logic inputs for more details about functions)

Variable	CANopenDir I4 [3299]
Unit	-
Init value	0
Min value	0
Max value	1
Description	Direction of logic input Normally open or Normally closed

Variable	Validity on CANopen digital input 4 [3267]
Unit	-
Init value	1
Min value	0
Max value	3
Description	Activation validity (0=Never/1=Always/2=Post Starting/3= rpm & Volt Stabilized)

Variable	CANopenTM I4 [3235]
Unit	s
Init value	0.0
Min value	0.0
Max value	6553.5
Description	Function execution delay, user can add execution delay after logic input status change

CANopen DI 5 (Customisable) [804]

Variable	CANopenFuncI5 [3204]
Unit	-
Init value	0
Min value	0
Max value	10299
Description	selection of the function, which will be executed when the logic input changes state . (see functions on logic inputs for more details about functions)

Variable	CANopenDir I5 [3300]
Unit	-
Init value	0
Min value	0
Max value	1
Description	Direction of logic input Normally open or Normally closed

Variable	Validity on CANopen digital input 5 [3268]
Unit	-
Init value	1
Min value	0
Max value	3
Description	Activation validity (0=Never/1=Always/2=Post Starting/3= rpm & Volt Stabilized)

Variable	CANopenTM I5 [3236]
Unit	s
Init value	0.0
Min value	0.0
Max value	6553.5
Description	Function execution delay, user can add execution delay after logic input status change

CANopen DI 6 (Customisable) [805]

Variable	CANopenFuncI6 [3205]
Unit	-
Init value	0
Min value	0
Max value	10299
Description	selection of the function, which will be executed when the logic input changes state . (see functions on logic inputs for more details about functions)

Variable	CANopenDir I6 [3301]
Unit	-
Init value	0
Min value	0
Max value	1
Description	Direction of logic input Normally open or Normally closed

Variable	Validity on CANopen digital input 6 [3269]
Unit	-
Init value	1
Min value	0
Max value	3
Description	Activation validity (0=Never/1=Always/2=Post Starting/3= rpm & Volt Stabilized)

Variable	CANopenTM I6 [3237]
Unit	s
Init value	0.0
Min value	0.0
Max value	6553.5
Description	Function execution delay, user can add execution delay after logic input status change

CANopen DI 7 (Customisable) [806]

Variable	CANopenFuncI7 [3206]
Unit	-
Init value	0
Min value	0
Max value	10299
Description	selection of the function, which will be executed when the logic input changes state . (see functions on logic inputs for more details about functions)

Variable	CANopenDir I7 [3302]
Unit	-
Init value	0
Min value	0
Max value	1
Description	Direction of logic input Normally open or Normally closed

Variable	Validity on CANopen digital input 7 [3270]
Unit	-
Init value	1
Min value	0
Max value	3
Description	Activation validity (0=Never/1=Always/2=Post Starting/3= rpm & Volt Stabilized)

Variable	CANopenTM I7 [3238]
Unit	s
Init value	0.0
Min value	0.0
Max value	6553.5
Description	Function execution delay, user can add execution delay after logic input status change

CANopen DI 8 (Customisable) [807]

Variable	CANopenFuncI8 [3207]
Unit	-
Init value	0
Min value	0
Max value	10299
Description	selection of the function, which will be executed when the logic input changes state . (see functions on logic inputs for more details about functions)

Variable	CANopenDir I8 [3303]
Unit	-
Init value	0
Min value	0
Max value	1
Description	Direction of logic input Normally open or Normally closed

Variable	Validity on CANopen digital input 8 [3271]
Unit	-
Init value	1
Min value	0
Max value	3
Description	Activation validity (0=Never/1=Always/2=Post Starting/3= rpm & Volt Stabilized)

Variable	CANopenTM I8 [3239]
Unit	s
Init value	0.0
Min value	0.0
Max value	6553.5
Description	Function execution delay, user can add execution delay after logic input status change

CANopen DI 9 (Customisable) [808]

Variable	CANopenFuncI9 [3208]
Unit	-
Init value	0
Min value	0
Max value	10299
Description	selection of the function, which will be executed when the logic input changes state . (see functions on logic inputs for more details about functions)

Variable	CANopenDir I9 [3304]
Unit	-
Init value	0
Min value	0
Max value	1
Description	Direction of logic input Normally open or Normally closed

Variable	Validity on CANopen digital input 9 [3272]
Unit	-
Init value	1
Min value	0
Max value	3
Description	Activation validity (0=Never/1=Always/2=Post Starting/3= rpm & Volt Stabilized)

Variable	CANopenTM I9 [3240]
Unit	s
Init value	0.0
Min value	0.0
Max value	6553.5
Description	Function execution delay, user can add execution delay after logic input status change

CANopen DI 10 (Customisable) [809]

Variable	CANopenFuncI10 [3209]
Unit	-
Init value	0
Min value	0
Max value	10299
Description	selection of the function, which will be executed when the logic input changes state . (see functions on logic inputs for more details about functions)

Variable	CANopenDir I10 [3305]
Unit	-
Init value	0
Min value	0
Max value	1
Description	Direction of logic input Normally open or Normally closed

Variable	Validity on CANopen digital input 10 [3273]
Unit	-
Init value	1
Min value	0
Max value	3
Description	Activation validity (0=Never/1=Always/2=Post Starting/3= rpm & Volt Stabilized)

Variable	CANopenTM I10 [3241]
Unit	s
Init value	0.0
Min value	0.0
Max value	6553.5
Description	Function execution delay, user can add execution delay after logic input status change

CANopen DI 11 (Customisable) [810]

Variable	CANopenFuncI11 [3210]
Unit	-
Init value	0
Min value	0
Max value	10299
Description	selection of the function, which will be executed when the logic input changes state . (see functions on logic inputs for more details about functions)

Variable	CANopenDir I11 [3306]
Unit	-
Init value	0
Min value	0
Max value	1
Description	Direction of logic input Normally open or Normally closed

Variable	Validity on CANopen digital input 11 [3274]
Unit	-
Init value	1
Min value	0
Max value	3
Description	Activation validity (0=Never/1=Always/2=Post Starting/3= rpm & Volt Stabilized)

Variable	CANopenTM I11 [3242]
Unit	s
Init value	0.0
Min value	0.0
Max value	6553.5
Description	Function execution delay, user can add execution delay after logic input status change

CANopen DI 12 (Customisable) [811]

Variable	CANopenFunc12 [3211]
Unit	-
Init value	0
Min value	0
Max value	10299
Description	selection of the function, which will be executed when the logic input changes state . (see functions on logic inputs for more details about functions)

Variable	CANopenDir I12 [3307]
Unit	-
Init value	0
Min value	0
Max value	1
Description	Direction of logic input Normally open or Normally closed

Variable	Validity on CANopen digital input 12 [3275]
Unit	-
Init value	1
Min value	0
Max value	3
Description	Activation validity (0=Never/1=Always/2=Post Starting/3= rpm & Volt Stabilized)

Variable	CANopenTM I12 [3243]
Unit	s
Init value	0.0
Min value	0.0
Max value	6553.5
Description	Function execution delay, user can add execution delay after logic input status change

CANopen DI 13 (Customisable) [812]

Variable	CANopenFuncI13 [3212]
Unit	-
Init value	0
Min value	0
Max value	10299
Description	selection of the function, which will be executed when the logic input changes state . (see functions on logic inputs for more details about functions)

Variable	CANopenDir I13 [3308]
Unit	-
Init value	0
Min value	0
Max value	1
Description	Direction of logic input Normally open or Normally closed

Variable	Validity on CANopen digital input 13 [3276]
Unit	-
Init value	1
Min value	0
Max value	3
Description	Activation validity (0=Never/1=Always/2=Post Starting/3= rpm & Volt Stabilized)

Variable	CANopenTM I13 [3244]
Unit	s
Init value	0.0
Min value	0.0
Max value	6553.5
Description	Function execution delay, user can add execution delay after logic input status change

CANopen DI 14 (Customisable) [813]

Variable	CANopenFunc14 [3213]
Unit	-
Init value	0
Min value	0
Max value	10299
Description	selection of the function, which will be executed when the logic input changes state . (see functions on logic inputs for more details about functions)

Variable	CANopenDir I14 [3309]
Unit	-
Init value	0
Min value	0
Max value	1
Description	Direction of logic input Normally open or Normally closed

Variable	Validity on CANopen digital input 14 [3277]
Unit	-
Init value	1
Min value	0
Max value	3
Description	Activation validity (0=Never/1=Always/2=Post Starting/3= rpm & Volt Stabilized)

Variable	CANopenTM I14 [3245]
Unit	s
Init value	0.0
Min value	0.0
Max value	6553.5
Description	Function execution delay, user can add execution delay after logic input status change

CANopen DI 15 (Customisable) [814]

Variable	CANopenFunc15 [3214]
Unit	-
Init value	0
Min value	0
Max value	10299
Description	selection of the function, which will be executed when the logic input changes state . (see functions on logic inputs for more details about functions)

Variable	CANopenDir I15 [3310]
Unit	-
Init value	0
Min value	0
Max value	1
Description	Direction of logic input Normally open or Normally closed

Variable	Validity on CANopen digital input 15 [3278]
Unit	-
Init value	1
Min value	0
Max value	3
Description	Activation validity (0=Never/1=Always/2=Post Starting/3= rpm & Volt Stabilized)

Variable	CANopenTM I15 [3246]
Unit	s
Init value	0.0
Min value	0.0
Max value	6553.5
Description	Function execution delay, user can add execution delay after logic input status change

CANopen DI 16 (Customisable) [815]

Variable	CANopenFunc16 [3215]
Unit	-
Init value	0
Min value	0
Max value	10299
Description	selection of the function, which will be executed when the logic input changes state . (see functions on logic inputs for more details about functions)

Variable	CANopenDir I16 [3311]
Unit	-
Init value	0
Min value	0
Max value	1
Description	Direction of logic input Normally open or Normally closed

Variable	Validity on CANopen digital input 16 [3279]
Unit	-
Init value	1
Min value	0
Max value	3
Description	Activation validity (0=Never/1=Always/2=Post Starting/3= rpm & Volt Stabilized)

Variable	CANopenTM I16 [3247]
Unit	s
Init value	0.0
Min value	0.0
Max value	6553.5
Description	Function execution delay, user can add execution delay after logic input status change

CANopen DI 17 (Customisable) [816]

Variable	CANopenFunc17 [3216]
Unit	-
Init value	0
Min value	0
Max value	10299
Description	selection of the function, which will be executed when the logic input changes state . (see functions on logic inputs for more details about functions)

Variable	CANopenDir I17 [3312]
Unit	-
Init value	0
Min value	0
Max value	1
Description	Direction of logic input Normally open or Normally closed

Variable	Validity on CANopen digital input 17 [3280]
Unit	-
Init value	1
Min value	0
Max value	3
Description	Activation validity (0=Never/1=Always/2=Post Starting/3= rpm & Volt Stabilized)

Variable	CANopenTM I17 [3248]
Unit	s
Init value	0.0
Min value	0.0
Max value	6553.5
Description	Function execution delay, user can add execution delay after logic input status change

CANopen DI 18 (Customisable) [817]

Variable	CANopenFunc18 [3217]
Unit	-
Init value	0
Min value	0
Max value	10299
Description	selection of the function, which will be executed when the logic input changes state . (see functions on logic inputs for more details about functions)

Variable	CANopenDir I18 [3313]
Unit	-
Init value	0
Min value	0
Max value	1
Description	Direction of logic input Normally open or Normally closed

Variable	Validity on CANopen digital input 18 [3281]
Unit	-
Init value	1
Min value	0
Max value	3
Description	Activation validity (0=Never/1=Always/2=Post Starting/3= rpm & Volt Stabilized)

Variable	CANopenTM I18 [3249]
Unit	s
Init value	0.0
Min value	0.0
Max value	6553.5
Description	Function execution delay, user can add execution delay after logic input status change

CANopen DI 19 (Customisable) [818]

Variable	CANopenFunc19 [3218]
Unit	-
Init value	0
Min value	0
Max value	10299
Description	selection of the function, which will be executed when the logic input changes state . (see functions on logic inputs for more details about functions)

Variable	CANopenDir I19 [3314]
Unit	-
Init value	0
Min value	0
Max value	1
Description	Direction of logic input Normally open or Normally closed

Variable	Validity on CANopen digital input 19 [3282]
Unit	-
Init value	1
Min value	0
Max value	3
Description	Activation validity (0=Never/1=Always/2=Post Starting/3= rpm & Volt Stabilized)

Variable	CANopenTM I19 [3250]
Unit	s
Init value	0.0
Min value	0.0
Max value	6553.5
Description	Function execution delay, user can add execution delay after logic input status change

CANopen DI 20 (Customisable) [819]

Variable	CANopenFuncI20 [3219]
Unit	-
Init value	0
Min value	0
Max value	10299
Description	selection of the function, which will be executed when the logic input changes state . (see functions on logic inputs for more details about functions)

Variable	CANopenDir I20 [3315]
Unit	-
Init value	0
Min value	0
Max value	1
Description	Direction of logic input Normally open or Normally closed

Variable	Validity on CANopen digital input 20 [3283]
Unit	-
Init value	1
Min value	0
Max value	3
Description	Activation validity (0=Never/1=Always/2=Post Starting/3= rpm & Volt Stabilized)

Variable	CANopenTM I20 [3251]
Unit	s
Init value	0.0
Min value	0.0
Max value	6553.5
Description	Function execution delay, user can add execution delay after logic input status change

CANopen DI 21 (Customisable) [820]

Variable	CANopenFuncI21 [3220]
Unit	-
Init value	0
Min value	0
Max value	10299
Description	selection of the function, which will be executed when the logic input changes state . (see functions on logic inputs for more details about functions)

Variable	CANopenDir I21 [3316]
Unit	-
Init value	0
Min value	0
Max value	1
Description	Direction of logic input Normally open or Normally closed

Variable	Validity on CANopen digital input 21 [3284]
Unit	-
Init value	1
Min value	0
Max value	3
Description	Activation validity (0=Never/1=Always/2=Post Starting/3= rpm & Volt Stabilized)

Variable	CANopenTM I21 [3252]
Unit	s
Init value	0.0
Min value	0.0
Max value	6553.5
Description	Function execution delay, user can add execution delay after logic input status change

CANopen DI 22 (Customisable) [821]

Variable	CANopenFuncI22 [3221]
Unit	-
Init value	0
Min value	0
Max value	10299
Description	selection of the function, which will be executed when the logic input changes state . (see functions on logic inputs for more details about functions)

Variable	CANopenDir I22 [3317]
Unit	-
Init value	0
Min value	0
Max value	1
Description	Direction of logic input Normally open or Normally closed

Variable	Validity on CANopen digital input 22 [3285]
Unit	-
Init value	1
Min value	0
Max value	3
Description	Activation validity (0=Never/1=Always/2=Post Starting/3= rpm & Volt Stabilized)

Variable	CANopenTM I22 [3253]
Unit	s
Init value	0.0
Min value	0.0
Max value	6553.5
Description	Function execution delay, user can add execution delay after logic input status change

CANopen DI 23 (Customisable) [822]

Variable	CANopenFuncI23 [3222]
Unit	-
Init value	0
Min value	0
Max value	10299
Description	selection of the function, which will be executed when the logic input changes state . (see functions on logic inputs for more details about functions)

Variable	CANopenDir I23 [3318]
Unit	-
Init value	0
Min value	0
Max value	1
Description	Direction of logic input Normally open or Normally closed

Variable	Validity on CANopen digital input 23 [3286]
Unit	-
Init value	1
Min value	0
Max value	3
Description	Activation validity (0=Never/1=Always/2=Post Starting/3= rpm & Volt Stabilized)

Variable	CANopenTM I23 [3254]
Unit	s
Init value	0.0
Min value	0.0
Max value	6553.5
Description	Function execution delay, user can add execution delay after logic input status change

CANopen DI 24 (Customisable) [823]

Variable	CANopenFuncI24 [3223]
Unit	-
Init value	0
Min value	0
Max value	10299
Description	selection of the function, which will be executed when the logic input changes state . (see functions on logic inputs for more details about functions)

Variable	CANopenDir I24 [3319]
Unit	-
Init value	0
Min value	0
Max value	1
Description	Direction of logic input Normally open or Normally closed

Variable	Validity on CANopen digital input 24 [3287]
Unit	-
Init value	1
Min value	0
Max value	3
Description	Activation validity (0=Never/1=Always/2=Post Starting/3= rpm & Volt Stabilized)

Variable	CANopenTM I24 [3255]
Unit	s
Init value	0.0
Min value	0.0
Max value	6553.5
Description	Function execution delay, user can add execution delay after logic input status change

CANopen DI 25 (Customisable) [824]

Variable	CANopenFuncI25 [3224]
Unit	-
Init value	0
Min value	0
Max value	10299
Description	selection of the function, which will be executed when the logic input changes state . (see functions on logic inputs for more details about functions)

Variable	CANopenDir I25 [3320]
Unit	-
Init value	0
Min value	0
Max value	1
Description	Direction of logic input Normally open or Normally closed

Variable	Validity on CANopen digital input 25 [3288]
Unit	-
Init value	1
Min value	0
Max value	3
Description	Activation validity (0=Never/1=Always/2=Post Starting/3= rpm & Volt Stabilized)

Variable	CANopenTM I25 [3256]
Unit	s
Init value	0.0
Min value	0.0
Max value	6553.5
Description	Function execution delay, user can add execution delay after logic input status change

CANopen DI 26 (Customisable) [825]

Variable	CANopenFuncI26 [3225]
Unit	-
Init value	0
Min value	0
Max value	10299
Description	selection of the function, which will be executed when the logic input changes state . (see functions on logic inputs for more details about functions)

Variable	CANopenDir I26 [3321]
Unit	-
Init value	0
Min value	0
Max value	1
Description	Direction of logic input Normally open or Normally closed

Variable	Validity on CANopen digital input 26 [3289]
Unit	-
Init value	1
Min value	0
Max value	3
Description	Activation validity (0=Never/1=Always/2=Post Starting/3= rpm & Volt Stabilized)

Variable	CANopenTM I26 [3257]
Unit	s
Init value	0.0
Min value	0.0
Max value	6553.5
Description	Function execution delay, user can add execution delay after logic input status change

CANopen DI 27 (Customisable) [826]

Variable	CANopenFuncI27 [3226]
Unit	-
Init value	0
Min value	0
Max value	10299
Description	selection of the function, which will be executed when the logic input changes state . (see functions on logic inputs for more details about functions)

Variable	CANopenDir I27 [3322]
Unit	-
Init value	0
Min value	0
Max value	1
Description	Direction of logic input Normally open or Normally closed

Variable	Validity on CANopen digital input 27 [3290]
Unit	-
Init value	1
Min value	0
Max value	3
Description	Activation validity (0=Never/1=Always/2=Post Starting/3= rpm & Volt Stabilized)

Variable	CANopenTM I27 [3258]
Unit	s
Init value	0.0
Min value	0.0
Max value	6553.5
Description	Function execution delay, user can add execution delay after logic input status change

CANopen DI 28 (Customisable) [827]

Variable	CANopenFuncI28 [3227]
Unit	-
Init value	0
Min value	0
Max value	10299
Description	selection of the function, which will be executed when the logic input changes state . (see functions on logic inputs for more details about functions)

Variable	CANopenDir I28 [3323]
Unit	-
Init value	0
Min value	0
Max value	1
Description	Direction of logic input Normally open or Normally closed

Variable	Validity on CANopen digital input 28 [3291]
Unit	-
Init value	1
Min value	0
Max value	3
Description	Activation validity (0=Never/1=Always/2=Post Starting/3= rpm & Volt Stabilized)

Variable	CANopenTM I28 [3259]
Unit	s
Init value	0.0
Min value	0.0
Max value	6553.5
Description	Function execution delay, user can add execution delay after logic input status change

CANopen DI 29 (Customisable) [828]

Variable	CANopenFuncI29 [3228]
Unit	-
Init value	0
Min value	0
Max value	10299
Description	selection of the function, which will be executed when the logic input changes state . (see functions on logic inputs for more details about functions)

Variable	CANopenDir I29 [3324]
Unit	-
Init value	0
Min value	0
Max value	1
Description	Direction of logic input Normally open or Normally closed

Variable	Validity on CANopen digital input 29 [3292]
Unit	-
Init value	1
Min value	0
Max value	3
Description	Activation validity (0=Never/1=Always/2=Post Starting/3= rpm & Volt Stabilized)

Variable	CANopenTM I29 [3260]
Unit	s
Init value	0.0
Min value	0.0
Max value	6553.5
Description	Function execution delay, user can add execution delay after logic input status change

CANopen DI 30 (Customisable) [829]

Variable	CANopenFuncI30 [3229]
Unit	-
Init value	0
Min value	0
Max value	10299
Description	selection of the function, which will be executed when the logic input changes state . (see functions on logic inputs for more details about functions)

Variable	CANopenDir I30 [3325]
Unit	-
Init value	0
Min value	0
Max value	1
Description	Direction of logic input Normally open or Normally closed

Variable	Validity on CANopen digital input 30 [3293]
Unit	-
Init value	1
Min value	0
Max value	3
Description	Activation validity (0=Never/1=Always/2=Post Starting/3= rpm & Volt Stabilized)

Variable	CANopenTM I30 [3261]
Unit	s
Init value	0.0
Min value	0.0
Max value	6553.5
Description	Function execution delay, user can add execution delay after logic input status change

CANopen DI 31 (Customisable) [830]

Variable	CANopenFuncI31 [3230]
Unit	-
Init value	0
Min value	0
Max value	10299
Description	selection of the function, which will be executed when the logic input changes state . (see functions on logic inputs for more details about functions)

Variable	CANopenDir I31 [3326]
Unit	-
Init value	0
Min value	0
Max value	1
Description	Direction of logic input Normally open or Normally closed

Variable	Validity on CANopen digital input 31 [3294]
Unit	-
Init value	1
Min value	0
Max value	3
Description	Activation validity (0=Never/1=Always/2=Post Starting/3= rpm & Volt Stabilized)

Variable	CANopenTM I31 [3262]
Unit	s
Init value	0.0
Min value	0.0
Max value	6553.5
Description	Function execution delay, user can add execution delay after logic input status change

CANopen DI 32 (Customisable) [831]

Variable	CANopenFuncI32 [3231]
Unit	-
Init value	0
Min value	0
Max value	10299
Description	selection of the function, which will be executed when the logic input changes state . (see functions on logic inputs for more details about functions)

Variable	CANopenDir I32 [3327]
Unit	-
Init value	0
Min value	0
Max value	1
Description	Direction of logic input Normally open or Normally closed

Variable	Validity on CANopen digital input 32 [3295]
Unit	-
Init value	1
Min value	0
Max value	3
Description	Activation validity (0=Never/1=Always/2=Post Starting/3= rpm & Volt Stabilized)

Variable	CANopenTM I32 [3263]
Unit	s
Init value	0.0
Min value	0.0
Max value	6553.5
Description	Function execution delay, user can add execution delay after logic input status change

CANopen DI 33 (Customisable) [1250]

Variable	CANopenFuncI33 [8550]
Unit	-
Init value	0
Min value	0
Max value	10299
Description	selection of the function, which will be executed when the logic input changes state . (see functions on logic inputs for more details about functions)

Variable	CANopenDir I33 [8646]
Unit	-
Init value	0
Min value	0
Max value	1
Description	Direction of logic input Normally open or Normally closed

Variable	Validity on CANopen digital input 33 [8614]
Unit	-
Init value	1
Min value	0
Max value	3
Description	Activation validity (0=Never/1=Always/2=Post Starting/3= rpm & Volt Stabilized)

Variable	CANopenTM I33 [8582]
Unit	s
Init value	0.0
Min value	0.0
Max value	6553.5
Description	Function execution delay, user can add execution delay after logic input status change

CANopen DI 34 (Customisable) [1251]

Variable	CANopenFuncI34 [8551]
Unit	-
Init value	0
Min value	0
Max value	10299
Description	selection of the function, which will be executed when the logic input changes state . (see functions on logic inputs for more details about functions)

Variable	CANopenDir I34 [8647]
Unit	-
Init value	0
Min value	0
Max value	1
Description	Direction of logic input Normally open or Normally closed

Variable	Validity on CANopen digital input 34 [8615]
Unit	-
Init value	1
Min value	0
Max value	3
Description	Activation validity (0=Never/1=Always/2=Post Starting/3= rpm & Volt Stabilized)

Variable	CANopenTM I34 [8583]
Unit	s
Init value	0.0
Min value	0.0
Max value	6553.5
Description	Function execution delay, user can add execution delay after logic input status change

CANopen DI 35 (Customisable) [1252]

Variable	CANopenFuncI35 [8552]
Unit	-
Init value	0
Min value	0
Max value	10299
Description	selection of the function, which will be executed when the logic input changes state . (see functions on logic inputs for more details about functions)

Variable	CANopenDir I35 [8648]
Unit	-
Init value	0
Min value	0
Max value	1
Description	Direction of logic input Normally open or Normally closed

Variable	Validity on CANopen digital input 35 [8616]
Unit	-
Init value	1
Min value	0
Max value	3
Description	Activation validity (0=Never/1=Always/2=Post Starting/3= rpm & Volt Stabilized)

Variable	CANopenTM I35 [8584]
Unit	s
Init value	0.0
Min value	0.0
Max value	6553.5
Description	Function execution delay, user can add execution delay after logic input status change

CANopen DI 36 (Customisable) [1253]

Variable	CANopenFuncI36 [8553]
Unit	-
Init value	0
Min value	0
Max value	10299
Description	selection of the function, which will be executed when the logic input changes state . (see functions on logic inputs for more details about functions)

Variable	CANopenDir I36 [8649]
Unit	-
Init value	0
Min value	0
Max value	1
Description	Direction of logic input Normally open or Normally closed

Variable	Validity on CANopen digital input 36 [8617]
Unit	-
Init value	1
Min value	0
Max value	3
Description	Activation validity (0=Never/1=Always/2=Post Starting/3= rpm & Volt Stabilized)

Variable	CANopenTM I36 [8585]
Unit	s
Init value	0.0
Min value	0.0
Max value	6553.5
Description	Function execution delay, user can add execution delay after logic input status change

CANopen DI 37 (Customisable) [1254]

Variable	CANopenFuncI37 [8554]
Unit	-
Init value	0
Min value	0
Max value	10299
Description	selection of the function, which will be executed when the logic input changes state . (see functions on logic inputs for more details about functions)

Variable	CANopenDir I37 [8650]
Unit	-
Init value	0
Min value	0
Max value	1
Description	Direction of logic input Normally open or Normally closed

Variable	Validity on CANopen digital input 37 [8618]
Unit	-
Init value	1
Min value	0
Max value	3
Description	Activation validity (0=Never/1=Always/2=Post Starting/3= rpm & Volt Stabilized)

Variable	CANopenTM I37 [8586]
Unit	s
Init value	0.0
Min value	0.0
Max value	6553.5
Description	Function execution delay, user can add execution delay after logic input status change

CANopen DI 38 (Customisable) [1255]

Variable	CANopenFuncI38 [8555]
Unit	-
Init value	0
Min value	0
Max value	10299
Description	selection of the function, which will be executed when the logic input changes state . (see functions on logic inputs for more details about functions)

Variable	CANopenDir I38 [8651]
Unit	-
Init value	0
Min value	0
Max value	1
Description	Direction of logic input Normally open or Normally closed

Variable	Validity on CANopen digital input 38 [8619]
Unit	-
Init value	1
Min value	0
Max value	3
Description	Activation validity (0=Never/1=Always/2=Post Starting/3= rpm & Volt Stabilized)

Variable	CANopenTM I38 [8587]
Unit	s
Init value	0.0
Min value	0.0
Max value	6553.5
Description	Function execution delay, user can add execution delay after logic input status change

CANopen DI 39 (Customisable) [1256]

Variable	CANopenFuncI39 [8556]
Unit	-
Init value	0
Min value	0
Max value	10299
Description	selection of the function, which will be executed when the logic input changes state . (see functions on logic inputs for more details about functions)

Variable	CANopenDir I39 [8652]
Unit	-
Init value	0
Min value	0
Max value	1
Description	Direction of logic input Normally open or Normally closed

Variable	Validity on CANopen digital input 39 [8620]
Unit	-
Init value	1
Min value	0
Max value	3
Description	Activation validity (0=Never/1=Always/2=Post Starting/3= rpm & Volt Stabilized)

Variable	CANopenTM I39 [8588]
Unit	s
Init value	0.0
Min value	0.0
Max value	6553.5
Description	Function execution delay, user can add execution delay after logic input status change

CANopen DI 40 (Customisable) [1257]

Variable	CANopenFuncI40 [8557]
Unit	-
Init value	0
Min value	0
Max value	10299
Description	selection of the function, which will be executed when the logic input changes state . (see functions on logic inputs for more details about functions)

Variable	CANopenDir I40 [8653]
Unit	-
Init value	0
Min value	0
Max value	1
Description	Direction of logic input Normally open or Normally closed

Variable	Validity on CANopen digital input 40 [8621]
Unit	-
Init value	1
Min value	0
Max value	3
Description	Activation validity (0=Never/1=Always/2=Post Starting/3= rpm & Volt Stabilized)

Variable	CANopenTM I40 [8589]
Unit	s
Init value	0.0
Min value	0.0
Max value	6553.5
Description	Function execution delay, user can add execution delay after logic input status change

CANopen DI 41 (Customisable) [1258]

Variable	CANopenFuncI41 [8558]
Unit	-
Init value	0
Min value	0
Max value	10299
Description	selection of the function, which will be executed when the logic input changes state . (see functions on logic inputs for more details about functions)

Variable	CANopenDir I41 [8654]
Unit	-
Init value	0
Min value	0
Max value	1
Description	Direction of logic input Normally open or Normally closed

Variable	Validity on CANopen digital input 41 [8622]
Unit	-
Init value	1
Min value	0
Max value	3
Description	Activation validity (0=Never/1=Always/2=Post Starting/3= rpm & Volt Stabilized)

Variable	CANopenTM I41 [8590]
Unit	s
Init value	0.0
Min value	0.0
Max value	6553.5
Description	Function execution delay, user can add execution delay after logic input status change

CANopen DI 42 (Customisable) [1259]

Variable	CANopenFuncI42 [8559]
Unit	-
Init value	0
Min value	0
Max value	10299
Description	selection of the function, which will be executed when the logic input changes state . (see functions on logic inputs for more details about functions)

Variable	CANopenDir I42 [8655]
Unit	-
Init value	0
Min value	0
Max value	1
Description	Direction of logic input Normally open or Normally closed

Variable	Validity on CANopen digital input 42 [8623]
Unit	-
Init value	1
Min value	0
Max value	3
Description	Activation validity (0=Never/1=Always/2=Post Starting/3= rpm & Volt Stabilized)

Variable	CANopenTM I42 [8591]
Unit	s
Init value	0.0
Min value	0.0
Max value	6553.5
Description	Function execution delay, user can add execution delay after logic input status change

CANopen DI 43 (Customisable) [1260]

Variable	CANopenFuncI43 [8560]
Unit	-
Init value	0
Min value	0
Max value	10299
Description	selection of the function, which will be executed when the logic input changes state . (see functions on logic inputs for more details about functions)

Variable	CANopenDir I43 [8656]
Unit	-
Init value	0
Min value	0
Max value	1
Description	Direction of logic input Normally open or Normally closed

Variable	Validity on CANopen digital input 43 [8624]
Unit	-
Init value	1
Min value	0
Max value	3
Description	Activation validity (0=Never/1=Always/2=Post Starting/3= rpm & Volt Stabilized)

Variable	CANopenTM I43 [8592]
Unit	s
Init value	0.0
Min value	0.0
Max value	6553.5
Description	Function execution delay, user can add execution delay after logic input status change

CANopen DI 44 (Customisable) [1261]

Variable	CANopenFuncI44 [8561]
Unit	-
Init value	0
Min value	0
Max value	10299
Description	selection of the function, which will be executed when the logic input changes state . (see functions on logic inputs for more details about functions)

Variable	CANopenDir I44 [8657]
Unit	-
Init value	0
Min value	0
Max value	1
Description	Direction of logic input Normally open or Normally closed

Variable	Validity on CANopen digital input 44 [8625]
Unit	-
Init value	1
Min value	0
Max value	3
Description	Activation validity (0=Never/1=Always/2=Post Starting/3= rpm & Volt Stabilized)

Variable	CANopenTM I44 [8593]
Unit	s
Init value	0.0
Min value	0.0
Max value	6553.5
Description	Function execution delay, user can add execution delay after logic input status change

CANopen DI 45 (Customisable) [1262]

Variable	CANopenFuncI45 [8562]
Unit	-
Init value	0
Min value	0
Max value	10299
Description	selection of the function, which will be executed when the logic input changes state . (see functions on logic inputs for more details about functions)

Variable	CANopenDir I45 [8658]
Unit	-
Init value	0
Min value	0
Max value	1
Description	Direction of logic input Normally open or Normally closed

Variable	Validity on CANopen digital input 45 [8626]
Unit	-
Init value	1
Min value	0
Max value	3
Description	Activation validity (0=Never/1=Always/2=Post Starting/3= rpm & Volt Stabilized)

Variable	CANopenTM I45 [8594]
Unit	s
Init value	0.0
Min value	0.0
Max value	6553.5
Description	Function execution delay, user can add execution delay after logic input status change

CANopen DI 46 (Customisable) [1263]

Variable	CANopenFuncI46 [8563]
Unit	-
Init value	0
Min value	0
Max value	10299
Description	selection of the function, which will be executed when the logic input changes state . (see functions on logic inputs for more details about functions)

Variable	CANopenDir I46 [8659]
Unit	-
Init value	0
Min value	0
Max value	1
Description	Direction of logic input Normally open or Normally closed

Variable	Validity on CANopen digital input 46 [8627]
Unit	-
Init value	1
Min value	0
Max value	3
Description	Activation validity (0=Never/1=Always/2=Post Starting/3= rpm & Volt Stabilized)

Variable	CANopenTM I46 [8595]
Unit	s
Init value	0.0
Min value	0.0
Max value	6553.5
Description	Function execution delay, user can add execution delay after logic input status change

CANopen DI 47 (Customisable) [1264]

Variable	CANopenFuncI47 [8564]
Unit	-
Init value	0
Min value	0
Max value	10299
Description	selection of the function, which will be executed when the logic input changes state . (see functions on logic inputs for more details about functions)

Variable	CANopenDir I47 [8660]
Unit	-
Init value	0
Min value	0
Max value	1
Description	Direction of logic input Normally open or Normally closed

Variable	Validity on CANopen digital input 47 [8628]
Unit	-
Init value	1
Min value	0
Max value	3
Description	Activation validity (0=Never/1=Always/2=Post Starting/3= rpm & Volt Stabilized)

Variable	CANopenTM I47 [8596]
Unit	s
Init value	0.0
Min value	0.0
Max value	6553.5
Description	Function execution delay, user can add execution delay after logic input status change

CANopen DI 48 (Customisable) [1265]

Variable	CANopenFuncI48 [8565]
Unit	-
Init value	0
Min value	0
Max value	10299
Description	selection of the function, which will be executed when the logic input changes state . (see functions on logic inputs for more details about functions)

Variable	CANopenDir I48 [8661]
Unit	-
Init value	0
Min value	0
Max value	1
Description	Direction of logic input Normally open or Normally closed

Variable	Validity on CANopen digital input 48 [8629]
Unit	-
Init value	1
Min value	0
Max value	3
Description	Activation validity (0=Never/1=Always/2=Post Starting/3= rpm & Volt Stabilized)

Variable	CANopenTM I48 [8597]
Unit	s
Init value	0.0
Min value	0.0
Max value	6553.5
Description	Function execution delay, user can add execution delay after logic input status change

CANopen DI 49 (Customisable) [1266]

Variable	CANopenFuncI49 [8566]
Unit	-
Init value	0
Min value	0
Max value	10299
Description	selection of the function, which will be executed when the logic input changes state . (see functions on logic inputs for more details about functions)

Variable	CANopenDir I49 [8662]
Unit	-
Init value	0
Min value	0
Max value	1
Description	Direction of logic input Normally open or Normally closed

Variable	Validity on CANopen digital input 49 [8630]
Unit	-
Init value	1
Min value	0
Max value	3
Description	Activation validity (0=Never/1=Always/2=Post Starting/3= rpm & Volt Stabilized)

Variable	CANopenTM I49 [8598]
Unit	s
Init value	0.0
Min value	0.0
Max value	6553.5
Description	Function execution delay, user can add execution delay after logic input status change

CANopen DI 50 (Customisable) [1267]

Variable	CANopenFuncI50 [8567]
Unit	-
Init value	0
Min value	0
Max value	10299
Description	selection of the function, which will be executed when the logic input changes state . (see functions on logic inputs for more details about functions)

Variable	CANopenDir I50 [8663]
Unit	-
Init value	0
Min value	0
Max value	1
Description	Direction of logic input Normally open or Normally closed

Variable	Validity on CANopen digital input 50 [8631]
Unit	-
Init value	1
Min value	0
Max value	3
Description	Activation validity (0=Never/1=Always/2=Post Starting/3= rpm & Volt Stabilized)

Variable	CANopenTM I50 [8599]
Unit	s
Init value	0.0
Min value	0.0
Max value	6553.5
Description	Function execution delay, user can add execution delay after logic input status change

CANopen DI 51 (Customisable) [1268]

Variable	CANopenFuncI51 [8568]
Unit	-
Init value	0
Min value	0
Max value	10299
Description	selection of the function, which will be executed when the logic input changes state . (see functions on logic inputs for more details about functions)

Variable	CANopenDir I51 [8664]
Unit	-
Init value	0
Min value	0
Max value	1
Description	Direction of logic input Normally open or Normally closed

Variable	Validity on CANopen digital input 51 [8632]
Unit	-
Init value	1
Min value	0
Max value	3
Description	Activation validity (0=Never/1=Always/2=Post Starting/3= rpm & Volt Stabilized)

Variable	CANopenTM I51 [8600]
Unit	s
Init value	0.0
Min value	0.0
Max value	6553.5
Description	Function execution delay, user can add execution delay after logic input status change

CANopen DI 52 (Customisable) [1269]

Variable	CANopenFuncI52 [8569]
Unit	-
Init value	0
Min value	0
Max value	10299
Description	selection of the function, which will be executed when the logic input changes state . (see functions on logic inputs for more details about functions)

Variable	CANopenDir I52 [8665]
Unit	-
Init value	0
Min value	0
Max value	1
Description	Direction of logic input Normally open or Normally closed

Variable	Validity on CANopen digital input 52 [8633]
Unit	-
Init value	1
Min value	0
Max value	3
Description	Activation validity (0=Never/1=Always/2=Post Starting/3= rpm & Volt Stabilized)

Variable	CANopenTM I52 [8601]
Unit	s
Init value	0.0
Min value	0.0
Max value	6553.5
Description	Function execution delay, user can add execution delay after logic input status change

CANopen DI 53 (Customisable) [1270]

Variable	CANopenFuncI53 [8570]
Unit	-
Init value	0
Min value	0
Max value	10299
Description	selection of the function, which will be executed when the logic input changes state . (see functions on logic inputs for more details about functions)

Variable	CANopenDir I53 [8666]
Unit	-
Init value	0
Min value	0
Max value	1
Description	Direction of logic input Normally open or Normally closed

Variable	Validity on CANopen digital input 53 [8634]
Unit	-
Init value	1
Min value	0
Max value	3
Description	Activation validity (0=Never/1=Always/2=Post Starting/3= rpm & Volt Stabilized)

Variable	CANopenTM I53 [8602]
Unit	s
Init value	0.0
Min value	0.0
Max value	6553.5
Description	Function execution delay, user can add execution delay after logic input status change

CANopen DI 54 (Customisable) [1271]

Variable	CANopenFuncI54 [8571]
Unit	-
Init value	0
Min value	0
Max value	10299
Description	selection of the function, which will be executed when the logic input changes state . (see functions on logic inputs for more details about functions)

Variable	CANopenDir I54 [8667]
Unit	-
Init value	0
Min value	0
Max value	1
Description	Direction of logic input Normally open or Normally closed

Variable	Validity on CANopen digital input 54 [8635]
Unit	-
Init value	1
Min value	0
Max value	3
Description	Activation validity (0=Never/1=Always/2=Post Starting/3= rpm & Volt Stabilized)

Variable	CANopenTM I54 [8603]
Unit	s
Init value	0.0
Min value	0.0
Max value	6553.5
Description	Function execution delay, user can add execution delay after logic input status change

CANopen DI 55 (Customisable) [1272]

Variable	CANopenFuncI55 [8572]
Unit	-
Init value	0
Min value	0
Max value	10299
Description	selection of the function, which will be executed when the logic input changes state . (see functions on logic inputs for more details about functions)

Variable	CANopenDir I55 [8668]
Unit	-
Init value	0
Min value	0
Max value	1
Description	Direction of logic input Normally open or Normally closed

Variable	Validity on CANopen digital input 55 [8636]
Unit	-
Init value	1
Min value	0
Max value	3
Description	Activation validity (0=Never/1=Always/2=Post Starting/3= rpm & Volt Stabilized)

Variable	CANopenTM I55 [8604]
Unit	s
Init value	0.0
Min value	0.0
Max value	6553.5
Description	Function execution delay, user can add execution delay after logic input status change

CANopen DI 56 (Customisable) [1273]

Variable	CANopenFuncI56 [8573]
Unit	-
Init value	0
Min value	0
Max value	10299
Description	selection of the function, which will be executed when the logic input changes state . (see functions on logic inputs for more details about functions)

Variable	CANopenDir I56 [8669]
Unit	-
Init value	0
Min value	0
Max value	1
Description	Direction of logic input Normally open or Normally closed

Variable	Validity on CANopen digital input 56 [8637]
Unit	-
Init value	1
Min value	0
Max value	3
Description	Activation validity (0=Never/1=Always/2=Post Starting/3= rpm & Volt Stabilized)

Variable	CANopenTM I56 [8605]
Unit	s
Init value	0.0
Min value	0.0
Max value	6553.5
Description	Function execution delay, user can add execution delay after logic input status change

CANopen DI 57 (Customisable) [1274]

Variable	CANopenFuncI57 [8574]
Unit	-
Init value	0
Min value	0
Max value	10299
Description	selection of the function, which will be executed when the logic input changes state . (see functions on logic inputs for more details about functions)

Variable	CANopenDir I57 [8670]
Unit	-
Init value	0
Min value	0
Max value	1
Description	Direction of logic input Normally open or Normally closed

Variable	Validity on CANopen digital input 57 [8638]
Unit	-
Init value	1
Min value	0
Max value	3
Description	Activation validity (0=Never/1=Always/2=Post Starting/3= rpm & Volt Stabilized)

Variable	CANopenTM I57 [8606]
Unit	s
Init value	0.0
Min value	0.0
Max value	6553.5
Description	Function execution delay, user can add execution delay after logic input status change

CANopen DI 58 (Customisable) [1275]

Variable	CANopenFuncI58 [8575]
Unit	-
Init value	0
Min value	0
Max value	10299
Description	selection of the function, which will be executed when the logic input changes state . (see functions on logic inputs for more details about functions)

Variable	CANopenDir I58 [8671]
Unit	-
Init value	0
Min value	0
Max value	1
Description	Direction of logic input Normally open or Normally closed

Variable	Validity on CANopen digital input 58 [8639]
Unit	-
Init value	1
Min value	0
Max value	3
Description	Activation validity (0=Never/1=Always/2=Post Starting/3= rpm & Volt Stabilized)

Variable	CANopenTM I58 [8607]
Unit	s
Init value	0.0
Min value	0.0
Max value	6553.5
Description	Function execution delay, user can add execution delay after logic input status change

CANopen DI 59 (Customisable) [1276]

Variable	CANopenFuncI59 [8576]
Unit	-
Init value	0
Min value	0
Max value	10299
Description	selection of the function, which will be executed when the logic input changes state . (see functions on logic inputs for more details about functions)

Variable	CANopenDir I59 [8672]
Unit	-
Init value	0
Min value	0
Max value	1
Description	Direction of logic input Normally open or Normally closed

Variable	Validity on CANopen digital input 59 [8640]
Unit	-
Init value	1
Min value	0
Max value	3
Description	Activation validity (0=Never/1=Always/2=Post Starting/3= rpm & Volt Stabilized)

Variable	CANopenTM I59 [8608]
Unit	s
Init value	0.0
Min value	0.0
Max value	6553.5
Description	Function execution delay, user can add execution delay after logic input status change

CANopen DI 60 (Customisable) [1277]

Variable	CANopenFuncI60 [8577]
Unit	-
Init value	0
Min value	0
Max value	10299
Description	selection of the function, which will be executed when the logic input changes state . (see functions on logic inputs for more details about functions)

Variable	CANopenDir I60 [8673]
Unit	-
Init value	0
Min value	0
Max value	1
Description	Direction of logic input Normally open or Normally closed

Variable	Validity on CANopen digital input 60 [8641]
Unit	-
Init value	1
Min value	0
Max value	3
Description	Activation validity (0=Never/1=Always/2=Post Starting/3= rpm & Volt Stabilized)

Variable	CANopenTM I60 [8609]
Unit	s
Init value	0.0
Min value	0.0
Max value	6553.5
Description	Function execution delay, user can add execution delay after logic input status change

CANopen DI 61 (Customisable) [1278]

Variable	CANopenFuncI61 [8578]
Unit	-
Init value	0
Min value	0
Max value	10299
Description	selection of the function, which will be executed when the logic input changes state . (see functions on logic inputs for more details about functions)

Variable	CANopenDir I61 [8674]
Unit	-
Init value	0
Min value	0
Max value	1
Description	Direction of logic input Normally open or Normally closed

Variable	Validity on CANopen digital input 61 [8642]
Unit	-
Init value	1
Min value	0
Max value	3
Description	Activation validity (0=Never/1=Always/2=Post Starting/3= rpm & Volt Stabilized)

Variable	CANopenTM I61 [8610]
Unit	s
Init value	0.0
Min value	0.0
Max value	6553.5
Description	Function execution delay, user can add execution delay after logic input status change

CANopen DI 62 (Customisable) [1279]

Variable	CANopenFuncI62 [8579]
Unit	-
Init value	0
Min value	0
Max value	10299
Description	selection of the function, which will be executed when the logic input changes state . (see functions on logic inputs for more details about functions)

Variable	CANopenDir I62 [8675]
Unit	-
Init value	0
Min value	0
Max value	1
Description	Direction of logic input Normally open or Normally closed

Variable	Validity on CANopen digital input 62 [8643]
Unit	-
Init value	1
Min value	0
Max value	3
Description	Activation validity (0=Never/1=Always/2=Post Starting/3= rpm & Volt Stabilized)

Variable	CANopenTM I62 [8611]
Unit	s
Init value	0.0
Min value	0.0
Max value	6553.5
Description	Function execution delay, user can add execution delay after logic input status change

CANopen DI 63 (Customisable) [1280]

Variable	CANopenFuncI63 [8580]
Unit	-
Init value	0
Min value	0
Max value	10299
Description	selection of the function, which will be executed when the logic input changes state . (see functions on logic inputs for more details about functions)

Variable	CANopenDir I63 [8676]
Unit	-
Init value	0
Min value	0
Max value	1
Description	Direction of logic input Normally open or Normally closed

Variable	Validity on CANopen digital input 63 [8644]
Unit	-
Init value	1
Min value	0
Max value	3
Description	Activation validity (0=Never/1=Always/2=Post Starting/3= rpm & Volt Stabilized)

Variable	CANopenTM I63 [8612]
Unit	s
Init value	0.0
Min value	0.0
Max value	6553.5
Description	Function execution delay, user can add execution delay after logic input status change

CANopen DI 64 (Customisable) [1281]

Variable	CANopenFuncI64 [8581]
Unit	-
Init value	0
Min value	0
Max value	10299
Description	selection of the function, which will be executed when the logic input changes state . (see functions on logic inputs for more details about functions)

Variable	CANopenDir I64 [8677]
Unit	-
Init value	0
Min value	0
Max value	1
Description	Direction of logic input Normally open or Normally closed

Variable	Validity on CANopen digital input 64 [8645]
Unit	-
Init value	1
Min value	0
Max value	3
Description	Activation validity (0=Never/1=Always/2=Post Starting/3= rpm & Volt Stabilized)

Variable	CANopenTM I64 [8613]
Unit	s
Init value	0.0
Min value	0.0
Max value	6553.5
Description	Function execution delay, user can add execution delay after logic input status change

Digital outputs

CANopen DO 1 (Customisable) [4751]

Variable	CANopenFuncO1 [3350]
Unit	-
Init value	0
Min value	0
Max value	10299
Description	Status change of the open or closed logic output, depending on the selected function

Variable	CANopenModeO1 [3382]
Unit	-
Init value	0
Min value	0
Max value	1
Description	selection of the direction of the logic output, normally energized or de-energized

CANopen DO 2 (Customisable) [4752]

Variable	CANopenFuncO2 [3351]
Unit	-
Init value	0
Min value	0
Max value	10299
Description	Status change of the open or closed logic output, depending on the selected function

Variable	CANopenModeO2 [3383]
Unit	-
Init value	0
Min value	0
Max value	1
Description	selection of the direction of the logic output, normally energized or de-energized

CANopen DO 3 (Customisable) [4753]

Variable	CANopenFuncO3 [3352]
Unit	-
Init value	0
Min value	0
Max value	10299
Description	Status change of the open or closed logic output, depending on the selected function

Variable	CANopenModeO3 [3384]
Unit	-
Init value	0
Min value	0
Max value	1
Description	selection of the direction of the logic output, normally energized or de-energized

CANopen DO 4 (Customisable) [4754]

Variable	CANopenFuncO4 [3353]
Unit	-
Init value	0
Min value	0
Max value	10299
Description	Status change of the open or closed logic output, depending on the selected function

Variable	CANopenModeO4 [3385]
Unit	-
Init value	0
Min value	0
Max value	1
Description	selection of the direction of the logic output, normally energized or de-energized

CANopen DO 5 (Customisable) [4755]

Variable	CANopenFuncO5 [3354]
Unit	-
Init value	0
Min value	0
Max value	10299
Description	Status change of the open or closed logic output, depending on the selected function

Variable	CANopenModeO5 [3386]
Unit	-
Init value	0
Min value	0
Max value	1
Description	selection of the direction of the logic output, normally energized or de-energized

CANopen DO 6 (Customisable) [4756]

Variable	CANopenFuncO6 [3355]
Unit	-
Init value	0
Min value	0
Max value	10299
Description	Status change of the open or closed logic output, depending on the selected function

Variable	CANopenModeO6 [3387]
Unit	-
Init value	0
Min value	0
Max value	1
Description	selection of the direction of the logic output, normally energized or de-energized

CANopen DO 7 (Customisable) [4757]

Variable	CANopenFuncO7 [3356]
Unit	-
Init value	0
Min value	0
Max value	10299
Description	Status change of the open or closed logic output, depending on the selected function

Variable	CANopenModeO7 [3388]
Unit	-
Init value	0
Min value	0
Max value	1
Description	selection of the direction of the logic output, normally energized or de-energized

CANopen DO 8 (Customisable) [4758]

Variable	CANopenFuncO8 [3357]
Unit	-
Init value	0
Min value	0
Max value	10299
Description	Status change of the open or closed logic output, depending on the selected function

Variable	CANopenModeO8 [3389]
Unit	-
Init value	0
Min value	0
Max value	1
Description	selection of the direction of the logic output, normally energized or de-energized

CANopen DO 9 (Customisable) [4759]

Variable	CANopenFuncO9 [3358]
Unit	-
Init value	0
Min value	0
Max value	10299
Description	Status change of the open or closed logic output, depending on the selected function

Variable	CANopenModeO9 [3390]
Unit	-
Init value	0
Min value	0
Max value	1
Description	selection of the direction of the logic output, normally energized or de-energized

CANopen DO 10 (Customisable) [4760]

Variable	CANopenFuncO10 [3359]
Unit	-
Init value	0
Min value	0
Max value	10299
Description	Status change of the open or closed logic output, depending on the selected function

Variable	CANopenModeO10 [3391]
Unit	-
Init value	0
Min value	0
Max value	1
Description	selection of the direction of the logic output, normally energized or de-energized

CANopen DO 11 (Customisable) [4761]

Variable	CANopenFuncO11 [3360]
Unit	-
Init value	0
Min value	0
Max value	10299
Description	Status change of the open or closed logic output, depending on the selected function

Variable	CANopenModeO11 [3392]
Unit	-
Init value	0
Min value	0
Max value	1
Description	selection of the direction of the logic output, normally energized or de-energized

CANopen DO 12 (Customisable) [4762]

Variable	CANopenFuncO12 [3361]
Unit	-
Init value	0
Min value	0
Max value	10299
Description	Status change of the open or closed logic output, depending on the selected function

Variable	CANopenModeO12 [3393]
Unit	-
Init value	0
Min value	0
Max value	1
Description	selection of the direction of the logic output, normally energized or de-energized

CANopen DO 13 (Customisable) [4763]

Variable	CANopenFuncO13 [3362]
Unit	-
Init value	0
Min value	0
Max value	10299
Description	Status change of the open or closed logic output, depending on the selected function

Variable	CANopenModeO13 [3394]
Unit	-
Init value	0
Min value	0
Max value	1
Description	selection of the direction of the logic output, normally energized or de-energized

CANopen DO 14 (Customisable) [4764]

Variable	CANopenFuncO14 [3363]
Unit	-
Init value	0
Min value	0
Max value	10299
Description	Status change of the open or closed logic output, depending on the selected function

Variable	CANopenModeO14 [3395]
Unit	-
Init value	0
Min value	0
Max value	1
Description	selection of the direction of the logic output, normally energized or de-energized

CANopen DO 15 (Customisable) [4765]

Variable	CANopenFuncO15 [3364]
Unit	-
Init value	0
Min value	0
Max value	10299
Description	Status change of the open or closed logic output, depending on the selected function

Variable	CANopenModeO15 [3396]
Unit	-
Init value	0
Min value	0
Max value	1
Description	selection of the direction of the logic output, normally energized or de-energized

CANopen DO 16 (Customisable) [4766]

Variable	CANopenFuncO16 [3365]
Unit	-
Init value	0
Min value	0
Max value	10299
Description	Status change of the open or closed logic output, depending on the selected function

Variable	CANopenModeO16 [3397]
Unit	-
Init value	0
Min value	0
Max value	1
Description	selection of the direction of the logic output, normally energized or de-energized

CANopen DO 17 (Customisable) [4767]

Variable	CANopenFuncO17 [3366]
Unit	-
Init value	0
Min value	0
Max value	10299
Description	Status change of the open or closed logic output, depending on the selected function

Variable	CANopenModeO17 [3398]
Unit	-
Init value	0
Min value	0
Max value	1
Description	selection of the direction of the logic output, normally energized or de-energized

CANopen DO 18 (Customisable) [4768]

Variable	CANopenFuncO18 [3367]
Unit	-
Init value	0
Min value	0
Max value	10299
Description	Status change of the open or closed logic output, depending on the selected function

Variable	CANopenModeO18 [3399]
Unit	-
Init value	0
Min value	0
Max value	1
Description	selection of the direction of the logic output, normally energized or de-energized

CANopen DO 19 (Customisable) [4769]

Variable	CANopenFuncO19 [3368]
Unit	-
Init value	0
Min value	0
Max value	10299
Description	Status change of the open or closed logic output, depending on the selected function

Variable	CANopenModeO19 [3400]
Unit	-
Init value	0
Min value	0
Max value	1
Description	selection of the direction of the logic output, normally energized or de-energized

CANopen DO 20 (Customisable) [4770]

Variable	CANopenFuncO20 [3369]
Unit	-
Init value	0
Min value	0
Max value	10299
Description	Status change of the open or closed logic output, depending on the selected function

Variable	CANopenModeO20 [3401]
Unit	-
Init value	0
Min value	0
Max value	1
Description	selection of the direction of the logic output, normally energized or de-energized

CANopen DO 21 (Customisable) [4771]

Variable	CANopenFuncO21 [3370]
Unit	-
Init value	0
Min value	0
Max value	10299
Description	Status change of the open or closed logic output, depending on the selected function

Variable	CANopenModeO21 [3402]
Unit	-
Init value	0
Min value	0
Max value	1
Description	selection of the direction of the logic output, normally energized or de-energized

CANopen DO 22 (Customisable) [4772]

Variable	CANopenFuncO22 [3371]
Unit	-
Init value	0
Min value	0
Max value	10299
Description	Status change of the open or closed logic output, depending on the selected function

Variable	CANopenModeO22 [3403]
Unit	-
Init value	0
Min value	0
Max value	1
Description	selection of the direction of the logic output, normally energized or de-energized

CANopen DO 23 (Customisable) [4773]

Variable	CANopenFuncO23 [3372]
Unit	-
Init value	0
Min value	0
Max value	10299
Description	Status change of the open or closed logic output, depending on the selected function

Variable	CANopenModeO23 [3404]
Unit	-
Init value	0
Min value	0
Max value	1
Description	selection of the direction of the logic output, normally energized or de-energized

CANopen DO 24 (Customisable) [4774]

Variable	CANopenFuncO24 [3373]
Unit	-
Init value	0
Min value	0
Max value	10299
Description	Status change of the open or closed logic output, depending on the selected function

Variable	CANopenModeO24 [3405]
Unit	-
Init value	0
Min value	0
Max value	1
Description	selection of the direction of the logic output, normally energized or de-energized

CANopen DO 25 (Customisable) [4775]

Variable	CANopenFuncO25 [3374]
Unit	-
Init value	0
Min value	0
Max value	10299
Description	Status change of the open or closed logic output, depending on the selected function

Variable	CANopenModeO25 [3406]
Unit	-
Init value	0
Min value	0
Max value	1
Description	selection of the direction of the logic output, normally energized or de-energized

CANopen DO 26 (Customisable) [4776]

Variable	CANopenFuncO26 [3375]
Unit	-
Init value	0
Min value	0
Max value	10299
Description	Status change of the open or closed logic output, depending on the selected function

Variable	CANopenModeO26 [3407]
Unit	-
Init value	0
Min value	0
Max value	1
Description	selection of the direction of the logic output, normally energized or de-energized

CANopen DO 27 (Customisable) [4777]

Variable	CANopenFuncO27 [3376]
Unit	-
Init value	0
Min value	0
Max value	10299
Description	Status change of the open or closed logic output, depending on the selected function

Variable	CANopenModeO27 [3408]
Unit	-
Init value	0
Min value	0
Max value	1
Description	selection of the direction of the logic output, normally energized or de-energized

CANopen DO 28 (Customisable) [4778]

Variable	CANopenFuncO28 [3377]
Unit	-
Init value	0
Min value	0
Max value	10299
Description	Status change of the open or closed logic output, depending on the selected function

Variable	CANopenModeO28 [3409]
Unit	-
Init value	0
Min value	0
Max value	1
Description	selection of the direction of the logic output, normally energized or de-energized

CANopen DO 29 (Customisable) [4779]

Variable	CANopenFuncO29 [3378]
Unit	-
Init value	0
Min value	0
Max value	10299
Description	Status change of the open or closed logic output, depending on the selected function

Variable	CANopenModeO29 [3410]
Unit	-
Init value	0
Min value	0
Max value	1
Description	selection of the direction of the logic output, normally energized or de-energized

CANopen DO 30 (Customisable) [4780]

Variable	CANopenFuncO30 [3379]
Unit	-
Init value	0
Min value	0
Max value	10299
Description	Status change of the open or closed logic output, depending on the selected function

Variable	CANopenModeO30 [3411]
Unit	-
Init value	0
Min value	0
Max value	1
Description	selection of the direction of the logic output, normally energized or de-energized

CANopen DO 31 (Customisable) [4781]

Variable	CANopenFuncO31 [3380]
Unit	-
Init value	0
Min value	0
Max value	10299
Description	Status change of the open or closed logic output, depending on the selected function

Variable	CANopenModeO31 [3412]
Unit	-
Init value	0
Min value	0
Max value	1
Description	selection of the direction of the logic output, normally energized or de-energized

CANopen DO 32 (Customisable) [4782]

Variable	CANopenFuncO32 [3381]
Unit	-
Init value	0
Min value	0
Max value	10299
Description	Status change of the open or closed logic output, depending on the selected function

Variable	CANopenModeO32 [3413]
Unit	-
Init value	0
Min value	0
Max value	1
Description	selection of the direction of the logic output, normally energized or de-energized

CANopen DO 33 (Customisable) [5100]

Variable	CANopenFuncO33 [8700]
Unit	-
Init value	0
Min value	0
Max value	10299
Description	Status change of the open or closed logic output, depending on the selected function

Variable	CANopenModeO33 [8732]
Unit	-
Init value	0
Min value	0
Max value	1
Description	selection of the direction of the logic output, normally energized or de-energized

CANopen DO 34 (Customisable) [5101]

Variable	CANopenFuncO34 [8701]
Unit	-
Init value	0
Min value	0
Max value	10299
Description	Status change of the open or closed logic output, depending on the selected function

Variable	CANopenModeO34 [8733]
Unit	-
Init value	0
Min value	0
Max value	1
Description	selection of the direction of the logic output, normally energized or de-energized

CANopen DO 35 (Customisable) [5102]

Variable	CANopenFuncO35 [8702]
Unit	-
Init value	0
Min value	0
Max value	10299
Description	Status change of the open or closed logic output, depending on the selected function

Variable	CANopenModeO35 [8734]
Unit	-
Init value	0
Min value	0
Max value	1
Description	selection of the direction of the logic output, normally energized or de-energized

CANopen DO 36 (Customisable) [5103]

Variable	CANopenFuncO36 [8703]
Unit	-
Init value	0
Min value	0
Max value	10299
Description	Status change of the open or closed logic output, depending on the selected function

Variable	CANopenModeO36 [8735]
Unit	-
Init value	0
Min value	0
Max value	1
Description	selection of the direction of the logic output, normally energized or de-energized

CANopen DO 37 (Customisable) [5104]

Variable	CANopenFuncO37 [8704]
Unit	-
Init value	0
Min value	0
Max value	10299
Description	Status change of the open or closed logic output, depending on the selected function

Variable	CANopenModeO37 [8736]
Unit	-
Init value	0
Min value	0
Max value	1
Description	selection of the direction of the logic output, normally energized or de-energized

CANopen DO 38 (Customisable) [5105]

Variable	CANopenFuncO38 [8705]
Unit	-
Init value	0
Min value	0
Max value	10299
Description	Status change of the open or closed logic output, depending on the selected function

Variable	CANopenModeO38 [8737]
Unit	-
Init value	0
Min value	0
Max value	1
Description	selection of the direction of the logic output, normally energized or de-energized

CANopen DO 39 (Customisable) [5106]

Variable	CANopenFuncO39 [8706]
Unit	-
Init value	0
Min value	0
Max value	10299
Description	Status change of the open or closed logic output, depending on the selected function

Variable	CANopenModeO39 [8738]
Unit	-
Init value	0
Min value	0
Max value	1
Description	selection of the direction of the logic output, normally energized or de-energized

CANopen DO 40 (Customisable) [5107]

Variable	CANopenFuncO40 [8707]
Unit	-
Init value	0
Min value	0
Max value	10299
Description	Status change of the open or closed logic output, depending on the selected function

Variable	CANopenModeO40 [8739]
Unit	-
Init value	0
Min value	0
Max value	1
Description	selection of the direction of the logic output, normally energized or de-energized

CANopen DO 41 (Customisable) [5108]

Variable	CANopenFuncO41 [8708]
Unit	-
Init value	0
Min value	0
Max value	10299
Description	Status change of the open or closed logic output, depending on the selected function

Variable	CANopenModeO41 [8740]
Unit	-
Init value	0
Min value	0
Max value	1
Description	selection of the direction of the logic output, normally energized or de-energized

CANopen DO 42 (Customisable) [5109]

Variable	CANopenFuncO42 [8709]
Unit	-
Init value	0
Min value	0
Max value	10299
Description	Status change of the open or closed logic output, depending on the selected function

Variable	CANopenModeO42 [8741]
Unit	-
Init value	0
Min value	0
Max value	1
Description	selection of the direction of the logic output, normally energized or de-energized

CANopen DO 43 (Customisable) [5110]

Variable	CANopenFuncO43 [8710]
Unit	-
Init value	0
Min value	0
Max value	10299
Description	Status change of the open or closed logic output, depending on the selected function

Variable	CANopenModeO43 [8742]
Unit	-
Init value	0
Min value	0
Max value	1
Description	selection of the direction of the logic output, normally energized or de-energized

CANopen DO 44 (Customisable) [5111]

Variable	CANopenFuncO44 [8711]
Unit	-
Init value	0
Min value	0
Max value	10299
Description	Status change of the open or closed logic output, depending on the selected function

Variable	CANopenModeO44 [8743]
Unit	-
Init value	0
Min value	0
Max value	1
Description	selection of the direction of the logic output, normally energized or de-energized

CANopen DO 45 (Customisable) [5112]

Variable	CANopenFuncO45 [8712]
Unit	-
Init value	0
Min value	0
Max value	10299
Description	Status change of the open or closed logic output, depending on the selected function

Variable	CANopenModeO45 [8744]
Unit	-
Init value	0
Min value	0
Max value	1
Description	selection of the direction of the logic output, normally energized or de-energized

CANopen DO 46 (Customisable) [5113]

Variable	CANopenFuncO46 [8713]
Unit	-
Init value	0
Min value	0
Max value	10299
Description	Status change of the open or closed logic output, depending on the selected function

Variable	CANopenModeO46 [8745]
Unit	-
Init value	0
Min value	0
Max value	1
Description	selection of the direction of the logic output, normally energized or de-energized

CANopen DO 47 (Customisable) [5114]

Variable	CANopenFuncO47 [8714]
Unit	-
Init value	0
Min value	0
Max value	10299
Description	Status change of the open or closed logic output, depending on the selected function

Variable	CANopenModeO47 [8746]
Unit	-
Init value	0
Min value	0
Max value	1
Description	selection of the direction of the logic output, normally energized or de-energized

CANopen DO 48 (Customisable) [5115]

Variable	CANopenFuncO48 [8715]
Unit	-
Init value	0
Min value	0
Max value	10299
Description	Status change of the open or closed logic output, depending on the selected function

Variable	CANopenModeO48 [8747]
Unit	-
Init value	0
Min value	0
Max value	1
Description	selection of the direction of the logic output, normally energized or de-energized

CANopen DO 49 (Customisable) [5116]

Variable	CANopenFuncO49 [8716]
Unit	-
Init value	0
Min value	0
Max value	10299
Description	Status change of the open or closed logic output, depending on the selected function

Variable	CANopenModeO49 [8748]
Unit	-
Init value	0
Min value	0
Max value	1
Description	selection of the direction of the logic output, normally energized or de-energized

CANopen DO 50 (Customisable) [5117]

Variable	CANopenFuncO50 [8717]
Unit	-
Init value	0
Min value	0
Max value	10299
Description	Status change of the open or closed logic output, depending on the selected function

Variable	CANopenModeO50 [8749]
Unit	-
Init value	0
Min value	0
Max value	1
Description	selection of the direction of the logic output, normally energized or de-energized

CANopen DO 51 (Customisable) [5118]

Variable	CANopenFuncO51 [8718]
Unit	-
Init value	0
Min value	0
Max value	10299
Description	Status change of the open or closed logic output, depending on the selected function

Variable	CANopenModeO51 [8750]
Unit	-
Init value	0
Min value	0
Max value	1
Description	selection of the direction of the logic output, normally energized or de-energized

CANopen DO 52 (Customisable) [5119]

Variable	CANopenFuncO52 [8719]
Unit	-
Init value	0
Min value	0
Max value	10299
Description	Status change of the open or closed logic output, depending on the selected function

Variable	CANopenModeO52 [8751]
Unit	-
Init value	0
Min value	0
Max value	1
Description	selection of the direction of the logic output, normally energized or de-energized

CANopen DO 53 (Customisable) [5120]

Variable	CANopenFuncO53 [8720]
Unit	-
Init value	0
Min value	0
Max value	10299
Description	Status change of the open or closed logic output, depending on the selected function

Variable	CANopenModeO53 [8752]
Unit	-
Init value	0
Min value	0
Max value	1
Description	selection of the direction of the logic output, normally energized or de-energized

CANopen DO 54 (Customisable) [5121]

Variable	CANopenFuncO54 [8721]
Unit	-
Init value	0
Min value	0
Max value	10299
Description	Status change of the open or closed logic output, depending on the selected function

Variable	CANopenModeO54 [8753]
Unit	-
Init value	0
Min value	0
Max value	1
Description	selection of the direction of the logic output, normally energized or de-energized

CANopen DO 55 (Customisable) [5122]

Variable	CANopenFuncO55 [8722]
Unit	-
Init value	0
Min value	0
Max value	10299
Description	Status change of the open or closed logic output, depending on the selected function

Variable	CANopenModeO55 [8754]
Unit	-
Init value	0
Min value	0
Max value	1
Description	selection of the direction of the logic output, normally energized or de-energized

CANopen DO 56 (Customisable) [5123]

Variable	CANopenFuncO56 [8723]
Unit	-
Init value	0
Min value	0
Max value	10299
Description	Status change of the open or closed logic output, depending on the selected function

Variable	CANopenModeO56 [8755]
Unit	-
Init value	0
Min value	0
Max value	1
Description	selection of the direction of the logic output, normally energized or de-energized

CANopen DO 57 (Customisable) [5124]

Variable	CANopenFuncO57 [8724]
Unit	-
Init value	0
Min value	0
Max value	10299
Description	Status change of the open or closed logic output, depending on the selected function

Variable	CANopenModeO57 [8756]
Unit	-
Init value	0
Min value	0
Max value	1
Description	selection of the direction of the logic output, normally energized or de-energized

CANopen DO 58 (Customisable) [5125]

Variable	CANopenFuncO58 [8725]
Unit	-
Init value	0
Min value	0
Max value	10299
Description	Status change of the open or closed logic output, depending on the selected function

Variable	CANopenModeO58 [8757]
Unit	-
Init value	0
Min value	0
Max value	1
Description	selection of the direction of the logic output, normally energized or de-energized

CANopen DO 59 (Customisable) [5126]

Variable	CANopenFuncO59 [8726]
Unit	-
Init value	0
Min value	0
Max value	10299
Description	Status change of the open or closed logic output, depending on the selected function

Variable	CANopenModeO59 [8758]
Unit	-
Init value	0
Min value	0
Max value	1
Description	selection of the direction of the logic output, normally energized or de-energized

CANopen DO 60 (Customisable) [5127]

Variable	CANopenFuncO60 [8727]
Unit	-
Init value	0
Min value	0
Max value	10299
Description	Status change of the open or closed logic output, depending on the selected function

Variable	CANopenModeO60 [8759]
Unit	-
Init value	0
Min value	0
Max value	1
Description	selection of the direction of the logic output, normally energized or de-energized

CANopen DO 61 (Customisable) [5128]

Variable	CANopenFuncO61 [8728]
Unit	-
Init value	0
Min value	0
Max value	10299
Description	Status change of the open or closed logic output, depending on the selected function

Variable	CANopenModeO61 [8760]
Unit	-
Init value	0
Min value	0
Max value	1
Description	selection of the direction of the logic output, normally energized or de-energized

CANopen DO 62 (Customisable) [5129]

Variable	CANopenFuncO62 [8729]
Unit	-
Init value	0
Min value	0
Max value	10299
Description	Status change of the open or closed logic output, depending on the selected function

Variable	CANopenModeO62 [8761]
Unit	-
Init value	0
Min value	0
Max value	1
Description	selection of the direction of the logic output, normally energized or de-energized

CANopen DO 63 (Customisable) [5130]

Variable	CANopenFuncO63 [8730]
Unit	-
Init value	0
Min value	0
Max value	10299
Description	Status change of the open or closed logic output, depending on the selected function

Variable	CANopenModeO63 [8762]
Unit	-
Init value	0
Min value	0
Max value	1
Description	selection of the direction of the logic output, normally energized or de-energized

CANopen DO 64 (Customisable) [5131]

Variable	CANopenFuncO64 [8731]
Unit	-
Init value	0
Min value	0
Max value	10299
Description	Status change of the open or closed logic output, depending on the selected function

Variable	CANopenModeO64 [8763]
Unit	-
Init value	0
Min value	0
Max value	1
Description	selection of the direction of the logic output, normally energized or de-energized

Analog inputs

Analog inputs 1

Variable	CANopen AI 1 (Customisable) [1050]
Unit	-
Init value	0
Min value	-32768
Max value	32767
Description	CANopen analog input 1

Variable	CANopen Gain AI 01 [8351]
Unit	-
Init value	1.000
Min value	0.000
Max value	10.000
Description	Gain for CANopen analog input 1 value

Variable	CANopen Offset AI 01 [8350]
Unit	-
Init value	0
Min value	-32768
Max value	32767
Description	Offset for CANopen analog input 1 value

Analog inputs 2

Variable	CANopen AI 2 (Customisable) [1051]
Unit	-
Init value	0
Min value	-32768
Max value	32767
Description	CANopen analog input 2

Variable	CANopen Gain AI 02 [8353]
Unit	-
Init value	1.000
Min value	0.000
Max value	10.000
Description	Gain for CANopen analog input 2 value

Variable	CANopen Offset AI 02 [8352]
Unit	-
Init value	0
Min value	-32768
Max value	32767
Description	Offset for CANopen analog input 2 value

Analog inputs 3

Variable	CANopen AI 3 (Customisable) [1052]
Unit	-
Init value	0
Min value	-32768
Max value	32767
Description	CANopen analog input 3

Variable	CANopen Gain AI 03 [8355]
Unit	-
Init value	1.000
Min value	0.000
Max value	10.000
Description	Gain for CANopen analog input 3 value

Variable	CANopen Offset AI 03 [8354]
Unit	-
Init value	0
Min value	-32768
Max value	32767
Description	Offset for CANopen analog input 3 value

Analog inputs 4

Variable	CANopen AI 4 (Customisable) [1053]
Unit	-
Init value	0
Min value	-32768
Max value	32767
Description	CANopen analog input 4

Variable	CANopen Gain AI 04 [8357]
Unit	-
Init value	1.000
Min value	0.000
Max value	10.000
Description	Gain for CANopen analog input 4 value

Variable	CANopen Offset AI 04 [8356]
Unit	-
Init value	0
Min value	-32768
Max value	32767
Description	Offset for CANopen analog input 4 value

Analog inputs 5

Variable	CANopen AI 5 (Customisable) [1054]
Unit	-
Init value	0
Min value	-32768
Max value	32767
Description	CANopen analog input 5

Variable	CANopen Gain AI 05 [8359]
Unit	-
Init value	1.000
Min value	0.000
Max value	10.000
Description	Gain for CANopen analog input 5 value

Variable	CANopen Offset AI 05 [8358]
Unit	-
Init value	0
Min value	-32768
Max value	32767
Description	Offset for CANopen analog input 5 value

Analog inputs 6

Variable	CANopen AI 6 (Customisable) [1055]
Unit	-
Init value	0
Min value	-32768
Max value	32767
Description	CANopen analog input 6

Variable	CANopen Gain AI 06 [8361]
Unit	-
Init value	1.000
Min value	0.000
Max value	10.000
Description	Gain for CANopen analog input 6 value

Variable	CANopen Offset AI 06 [8360]
Unit	-
Init value	0
Min value	-32768
Max value	32767
Description	Offset for CANopen analog input 6 value

Analog inputs 7

Variable	CANopen AI 7 (Customisable) [1056]
Unit	-
Init value	0
Min value	-32768
Max value	32767
Description	CANopen analog input 7

Variable	CANopen Gain AI 07 [8363]
Unit	-
Init value	1.000
Min value	0.000
Max value	10.000
Description	Gain for CANopen analog input 7 value

Variable	CANopen Offset AI 07 [8362]
Unit	-
Init value	0
Min value	-32768
Max value	32767
Description	Offset for CANopen analog input 7 value

Analog inputs 8

Variable	CANopen AI 8 (Customisable) [1057]
Unit	-
Init value	0
Min value	-32768
Max value	32767
Description	CANopen analog input 8

Variable	CANopen Gain AI 08 [8365]
Unit	-
Init value	1.000
Min value	0.000
Max value	10.000
Description	Gain for CANopen analog input 8 value

Variable	CANopen Offset AI 08 [8364]
Unit	-
Init value	0
Min value	-32768
Max value	32767
Description	Offset for CANopen analog input 8 value

Analog inputs 9

Variable	CANopen AI 9 (Customisable) [1058]
Unit	-
Init value	0
Min value	-32768
Max value	32767
Description	CANopen analog input 9

Variable	CANopen Gain AI 09 [8367]
Unit	-
Init value	1.000
Min value	0.000
Max value	10.000
Description	Gain for CANopen analog input 9 value

Variable	CANopen Offset AI 09 [8366]
Unit	-
Init value	0
Min value	-32768
Max value	32767
Description	Offset for CANopen analog input 9 value

Analog inputs 10

Variable	CANopen AI 10 (Customisable) [1059]
Unit	-
Init value	0
Min value	-32768
Max value	32767
Description	CANopen analog input 10

Variable	CANopen Gain AI 10 [8369]
Unit	-
Init value	1.000
Min value	0.000
Max value	10.000
Description	Gain for CANopen analog input 10 value

Variable	CANopen Offset AI 10 [8368]
Unit	-
Init value	0
Min value	-32768
Max value	32767
Description	Offset for CANopen analog input 10 value

Analog inputs 11

Variable	CANopen AI 11 (Customisable) [1060]
Unit	-
Init value	0
Min value	-32768
Max value	32767
Description	CANopen analog input 11

Variable	CANopen Gain AI 11 [8371]
Unit	-
Init value	1.000
Min value	0.000
Max value	10.000
Description	Gain for CANopen analog input 11 value

Variable	CANopen Offset AI 11 [8370]
Unit	-
Init value	0
Min value	-32768
Max value	32767
Description	Offset for CANopen analog input 11 value

Analog inputs 12

Variable	CANopen AI 12 (Customisable) [1061]
Unit	-
Init value	0
Min value	-32768
Max value	32767
Description	CANopen analog input 12

Variable	CANopen Gain AI 12 [8373]
Unit	-
Init value	1.000
Min value	0.000
Max value	10.000
Description	Gain for CANopen analog input 12 value

Variable	CANopen Offset AI 12 [8372]
Unit	-
Init value	0
Min value	-32768
Max value	32767
Description	Offset for CANopen analog input 12 value

Analog inputs 13

Variable	CANopen AI 13 (Customisable) [1062]
Unit	-
Init value	0
Min value	-32768
Max value	32767
Description	CANopen analog input 13

Variable	CANopen Gain AI 13 [8375]
Unit	-
Init value	1.000
Min value	0.000
Max value	10.000
Description	Gain for CANopen analog input 13 value

Variable	CANopen Offset AI 13 [8374]
Unit	-
Init value	0
Min value	-32768
Max value	32767
Description	Offset for CANopen analog input 13 value

Analog inputs 14

Variable	CANopen AI 14 (Customisable) [1063]
Unit	-
Init value	0
Min value	-32768
Max value	32767
Description	CANopen analog input 14

Variable	CANopen Gain AI 14 [8377]
Unit	-
Init value	1.000
Min value	0.000
Max value	10.000
Description	Gain for CANopen analog input 14 value

Variable	CANopen Offset AI 14 [8376]
Unit	-
Init value	0
Min value	-32768
Max value	32767
Description	Offset for CANopen analog input 14 value

Analog inputs 15

Variable	CANopen AI 15 (Customisable) [1064]
Unit	-
Init value	0
Min value	-32768
Max value	32767
Description	CANopen analog input 15

Variable	CANopen Gain AI 15 [8379]
Unit	-
Init value	1.000
Min value	0.000
Max value	10.000
Description	Gain for CANopen analog input 15 value

Variable	CANopen Offset AI 15 [8378]
Unit	-
Init value	0
Min value	-32768
Max value	32767
Description	Offset for CANopen analog input 15 value

Analog inputs 16

Variable	CANopen AI 16 (Customisable) [1065]
Unit	-
Init value	0
Min value	-32768
Max value	32767
Description	CANopen analog input 16

Variable	CANopen Gain AI 16 [8381]
Unit	-
Init value	1.000
Min value	0.000
Max value	10.000
Description	Gain for CANopen analog input 16 value

Variable	CANopen Offset AI 16 [8380]
Unit	-
Init value	0
Min value	-32768
Max value	32767
Description	Offset for CANopen analog input 16 value

PROTECTIONS

BUS PROTECTIONS

Over/under frequency

Over frequency

Variable	Over frequency threshold [2400]
Unit	%
Init value	105.0
Min value	0.0
Max value	200.0
Description	Threshold to be exceeded to trigger the associated control for this protection.

Variable	Over frequency timer [2401]
Unit	s
Init value	30.0
Min value	0.0
Max value	999.9
Description	Timer defining how long the value should exceed the treshold before triggering the control associated to this protection.

Variable	Over frequency control [2402]
Unit	-
Init value	0
List	0: Unused 1: Bus electrical fault 3: Alarm 4: Fault (soft shutdown)
Description	Action performed on protection's trigger. Actions' description is available in the technical documentation.

Under frequency

Variable	Under frequency threshold [2403]
Unit	%
Init value	90.0
Min value	0.0
Max value	200.0
Description	Threshold to be exceeded to trigger the associated control for this protection.

Variable	Under frequency timer [2404]
Unit	s
Init value	10.0
Min value	0.0
Max value	999.9
Description	Timer defining how long the value should exceed the treshold before triggering the control associated to this protection.

Variable	Under frequency control [2405]
Unit	-
Init value	0
List	0: Unused 1: Bus electrical fault 3: Alarm 4: Fault (soft shutdown)
Description	Action performed on protection's trigger. Actions' description is available in the technical documentation.

Over frequency 2

Variable	Over frequency threshold 2 [2436]
Unit	%
Init value	110.0
Min value	0.0
Max value	200.0
Description	Threshold to be exceeded to trigger the associated control for this protection.

Variable	Over frequency timer 2 [2437]
Unit	s
Init value	10.0
Min value	0.0
Max value	999.9
Description	Timer defining how long the value should exceed the treshold before triggering the control associated to this protection.

Variable	Over frequency control 2 [2438]
Unit	-
Init value	0
List	0: Unused 1: Bus electrical fault 3: Alarm 4: Fault (soft shutdown)
Description	Action performed on protection's trigger. Actions' description is available in the technical documentation.

Under frequency 2

Variable	Under frequency threshold 2 [2439]
Unit	%
Init value	90.0
Min value	0.0
Max value	200.0
Description	Threshold to be exceeded to trigger the associated control for this protection.

Variable	Under frequency timer 2 [2440]
Unit	s
Init value	10.0
Min value	0.0
Max value	999.9
Description	Timer defining how long the value should exceed the treshold before triggering the control associated to this protection.

Variable	Under frequency control 2 [2441]
Unit	-
Init value	0
List	0: Unused 1: Bus electrical fault 3: Alarm 4: Fault (soft shutdown)
Description	Action performed on protection's trigger. Actions' description is available in the technical documentation.

Over/under voltage

Over voltage

Variable	Over voltage threshold [2406]
Unit	%
Init value	110.0
Min value	0.0
Max value	200.0
Description	Threshold to be exceeded to trigger the associated control for this protection.

Variable	Over voltage timer [2407]
Unit	s
Init value	10.0
Min value	0.0
Max value	999.9
Description	Timer defining how long the value should exceed the treshold before triggering the control associated to this protection.

Variable	Over voltage control [2408]
Unit	-
Init value	0
List	0: Unused 1: Bus electrical fault 3: Alarm 4: Fault (soft shutdown)
Description	Action performed on protection's trigger. Actions' description is available in the technical documentation.

Under voltage

Variable	Under voltage threshold [2409]
Unit	%
Init value	90.0
Min value	0.0
Max value	200.0
Description	Threshold to be exceeded to trigger the associated control for this protection.

Variable	Under voltage timer [2410]
Unit	s
Init value	20.0
Min value	0.0
Max value	999.9
Description	Timer defining how long the value should exceed the treshold before triggering the control associated to this protection.

Variable	Under voltage control [2411]
Unit	-
Init value	0
List	0: Unused 1: Bus electrical fault 3: Alarm 4: Fault (soft shutdown)
Description	Action performed on protection's trigger. Actions' description is available in the technical documentation.

Over voltage 2

Variable	Over voltage threshold 2 [2442]
Unit	%
Init value	110.0
Min value	0.0
Max value	200.0
Description	Threshold to be exceeded to trigger the associated control for this protection.

Variable	Over voltage timer 2 [2443]
Unit	s
Init value	10.0
Min value	0.0
Max value	999.9
Description	Timer defining how long the value should exceed the treshold before triggering the control associated to this protection.

Variable	Over voltage control 2 [2444]
Unit	-
Init value	0
List	0: Unused 1: Bus electrical fault 3: Alarm 4: Fault (soft shutdown)
Description	Action performed on protection's trigger. Actions' description is available in the technical documentation.

Under voltage 2

Variable	Under voltage threshold 2 [2445]
Unit	%
Init value	90.0
Min value	0.0
Max value	200.0
Description	Threshold to be exceeded to trigger the associated control for this protection.

Variable	Under voltage timer 2 [2446]
Unit	s
Init value	20.0
Min value	0.0
Max value	999.9
Description	Timer defining how long the value should exceed the treshold before triggering the control associated to this protection.

Variable	Under voltage control 2 [2447]
Unit	-
Init value	0
List	0: Unused 1: Bus electrical fault 3: Alarm 4: Fault (soft shutdown)
Description	Action performed on protection's trigger. Actions' description is available in the technical documentation.

Voltage unbalance

Voltage unbalance

Variable	Voltage unbalance threshold [2486]
Unit	%
Init value	5.0
Min value	0.0
Max value	200.0
Description	Threshold to be exceeded to trigger the associated control for this protection.

Variable	Voltage unbalance timer [2487]
Unit	s
Init value	3.0
Min value	0.0
Max value	999.9
Description	Timer defining how long the value should exceed the treshold before triggering the control associated to this protection.

Variable	Voltage unbalance control [2488]
Unit	-
Init value	0
List	0: Unused 1: Bus electrical fault 3: Alarm 4: Fault (soft shutdown)
Description	Action performed on protection's trigger. Actions' description is available in the technical documentation.

Voltage unbalance 2

Variable	Voltage unbalance threshold 2 [2489]
Unit	%
Init value	10.0
Min value	0.0
Max value	200.0
Description	Threshold to be exceeded to trigger the associated control for this protection.

Variable	Voltage unbalance timer 2 [2490]
Unit	s
Init value	3.0
Min value	0.0
Max value	999.9
Description	Timer defining how long the value should exceed the threshold before triggering the control associated to this protection.

Variable	Voltage unbalance control 2 [2491]
Unit	-
Init value	0
List	0: Unused 1: Bus electrical fault 3: Alarm 4: Fault (soft shutdown)
Description	Action performed on protection's trigger. Actions' description is available in the technical documentation.

Rotophase

Variable	Rotophase protection control [8501]
Unit	-
Init value	0
List	0: Unused 1: Bus electrical fault 3: Alarm 4: Fault (soft shutdown)
Description	Action performed on protection's trigger. Actions' description is available in the technical documentation.

OPERATOR MANUAL

Variable	Rotophase activation direction (0 = Indirect, 1 = Direct) [8500]
Unit	-
Init value	1
List	0: Indirect 1: Direct
Description	This setpoint define wich direction of rotophase will activate rotophase protection. If the setpoint is on direct then the action of variables 8500 will activate if voltage phases are plugged on a direct direction. If the setpoint is on indirect then the action of variables 8500 will activate if voltage phases are plugged on an indirect direction.

MAINS PROTECTIONS

Over/under frequency

Over frequency

Variable	Over frequency threshold [2500]
Unit	%
Init value	110.0
Min value	0.0
Max value	200.0
Description	Threshold to be exceeded to trigger the associated control for this protection.

Variable	Over frequency timer [2501]
Unit	s
Init value	10.0
Min value	0.0
Max value	999.9
Description	Timer defining how long the value should exceed the treshold before triggering the control associated to this protection.

Variable	Over frequency control [2502]
Unit	-
Init value	0
List	0: Unused 1: Bus electrical fault 2: Mains failure 3: Alarm 4: Fault (soft shutdown) 9: Mains electrical fault
Description	Action performed on protection's trigger. Actions' description is available in the technical documentation.

Under frequency

Variable	Under frequency threshold [2503]
Unit	%
Init value	90.0
Min value	0.0
Max value	200.0
Description	Threshold to be exceeded to trigger the associated control for this protection.

Variable	Under frequency timer [2504]
Unit	s
Init value	10.0
Min value	0.0
Max value	999.9
Description	Timer defining how long the value should exceed the treshold before triggering the control associated to this protection.

Variable	Under frequency control [2505]
Unit	-
Init value	2
List	0: Unused 1: Bus electrical fault 2: Mains failure 3: Alarm 4: Fault (soft shutdown) 9: Mains electrical fault
Description	Action performed on protection's trigger. Actions' description is available in the technical documentation.

Over frequency 2

Variable	Over frequency threshold 2 [2530]
Unit	%
Init value	110.0
Min value	0.0
Max value	200.0
Description	Threshold to be exceeded to trigger the associated control for this protection.

Variable	Over frequency timer 2 [2531]
Unit	s
Init value	10.0
Min value	0.0
Max value	999.9
Description	Timer defining how long the value should exceed the treshold before triggering the control associated to this protection.

Variable	Over frequency control 2 [2532]
Unit	-
Init value	0
List	0: Unused 1: Bus electrical fault 2: Mains failure 3: Alarm 4: Fault (soft shutdown) 9: Mains electrical fault
Description	Action performed on protection's trigger. Actions' description is available in the technical documentation.

Under frequency 2

Variable	Under frequency threshold 2 [2533]
Unit	%
Init value	90.0
Min value	0.0
Max value	200.0
Description	Threshold to be exceeded to trigger the associated control for this protection.

Variable	Under frequency timer 2 [2534]
Unit	s
Init value	10.0
Min value	0.0
Max value	999.9
Description	Timer defining how long the value should exceed the treshold before triggering the control associated to this protection.

Variable	Under frequency control 2 [2535]
Unit	-
Init value	0
List	0: Unused 1: Bus electrical fault 2: Mains failure 3: Alarm 4: Fault (soft shutdown) 9: Mains electrical fault
Description	Action performed on protection's trigger. Actions' description is available in the technical documentation.

Over/under voltage

Over voltage

Variable	Over voltage threshold [2506]
Unit	%
Init value	110.0
Min value	0.0
Max value	200.0
Description	Threshold to be exceeded to trigger the associated control for this protection.

Variable	Over voltage timer [2507]
Unit	s
Init value	10.0
Min value	0.0
Max value	999.9
Description	Timer defining how long the value should exceed the treshold before triggering the control associated to this protection.

Variable	Over voltage control [2508]
Unit	-
Init value	0
List	0: Unused 1: Bus electrical fault 2: Mains failure 3: Alarm 4: Fault (soft shutdown) 9: Mains electrical fault
Description	Action performed on protection's trigger. Actions' description is available in the technical documentation.

Under voltage

Variable	Under voltage threshold [2509]
Unit	%
Init value	90.0
Min value	0.0
Max value	200.0
Description	Threshold to be exceeded to trigger the associated control for this protection.

Variable	Under voltage timer [2510]
Unit	s
Init value	20.0
Min value	0.0
Max value	999.9
Description	Timer defining how long the value should exceed the treshold before triggering the control associated to this protection.

Variable	Under voltage control [2511]
Unit	-
Init value	2
List	0: Unused 1: Bus electrical fault 2: Mains failure 3: Alarm 4: Fault (soft shutdown) 9: Mains electrical fault
Description	Action performed on protection's trigger. Actions' description is available in the technical documentation.

Over voltage 2

Variable	Over voltage threshold 2 [2536]
Unit	%
Init value	110.0
Min value	0.0
Max value	200.0
Description	Threshold to be exceeded to trigger the associated control for this protection.

Variable	Over voltage timer 2 [2537]
Unit	s
Init value	10.0
Min value	0.0
Max value	999.9
Description	Timer defining how long the value should exceed the treshold before triggering the control associated to this protection.

Variable	Over voltage control 2 [2538]
Unit	-
Init value	0
List	0: Unused 1: Bus electrical fault 2: Mains failure 3: Alarm 4: Fault (soft shutdown) 9: Mains electrical fault
Description	Action performed on protection's trigger. Actions' description is available in the technical documentation.

Under voltage 2

Variable	Under voltage threshold 2 [2539]
Unit	%
Init value	90.0
Min value	0.0
Max value	200.0
Description	Threshold to be exceeded to trigger the associated control for this protection.

Variable	Under voltage timer 2 [2540]
Unit	s
Init value	20.0
Min value	0.0
Max value	999.9
Description	Timer defining how long the value should exceed the treshold before triggering the control associated to this protection.

Variable	Under voltage control 2 [2541]
Unit	-
Init value	0
List	0: Unused 1: Bus electrical fault 2: Mains failure 3: Alarm 4: Fault (soft shutdown) 9: Mains electrical fault
Description	Action performed on protection's trigger. Actions' description is available in the technical documentation.

Voltage/Current unbalance

Voltage unbalance

Variable	Voltage unbalance threshold [2565]
Unit	%
Init value	5.0
Min value	0.0
Max value	200.0
Description	Threshold to be exceeded to trigger the associated control for this protection.

Variable	Voltage unbalance timer [2566]
Unit	s
Init value	3.0
Min value	0.0
Max value	999.9
Description	Timer defining how long the value should exceed the treshold before triggering the control associated to this protection.

Variable	Voltage unbalance control [2567]
Unit	-
Init value	0
List	0: Unused 1: Bus electrical fault 3: Alarm 4: Fault (soft shutdown) 9: Mains electrical fault
Description	Action performed on protection's trigger. Actions' description is available in the technical documentation.

Voltage unbalance 2

Variable	Voltage unbalance threshold 2 [2568]
Unit	%
Init value	10.0
Min value	0.0
Max value	200.0
Description	Threshold to be exceeded to trigger the associated control for this protection.

Variable	Voltage unbalance timer 2 [2569]
Unit	s
Init value	3.0
Min value	0.0
Max value	999.9
Description	Timer defining how long the value should exceed the treshold before triggering the control associated to this protection.

Variable	Voltage unbalance control 2 [2570]
Unit	-
Init value	0
List	0: Unused 1: Bus electrical fault 3: Alarm 4: Fault (soft shutdown) 9: Mains electrical fault
Description	Action performed on protection's trigger. Actions' description is available in the technical documentation.

Current unbalance

Variable	Current unbalance threshold [2572]
Unit	%
Init value	40.0
Min value	0.0
Max value	200.0
Description	Threshold to be exceeded to trigger the associated control for this protection.

Variable	Current unbalance timer [2573]
Unit	s
Init value	3.0
Min value	0.0
Max value	999.9
Description	Timer defining how long the value should exceed the treshold before triggering the control associated to this protection.

Variable	Current unbalance control [2574]
Unit	-
Init value	0
List	0: Unused 1: Bus electrical fault 3: Alarm 4: Fault (soft shutdown) 9: Mains electrical fault
Description	Action performed on protection's trigger. Actions' description is available in the technical documentation.

Current unbalance 2

Variable	Current unbalance threshold 2 [2575]
Unit	%
Init value	60.0
Min value	0.0
Max value	200.0
Description	Threshold to be exceeded to trigger the associated control for this protection.

Variable	Current unbalance timer 2 [2576]
Unit	s
Init value	3.0
Min value	0.0
Max value	999.9
Description	Timer defining how long the value should exceed the treshold before triggering the control associated to this protection.

Variable	Current unbalance control 2 [2577]
Unit	-
Init value	0
List	0: Unused 1: Bus electrical fault 3: Alarm 4: Fault (soft shutdown) 9: Mains electrical fault
Description	Action performed on protection's trigger. Actions' description is available in the technical documentation.

Rotophase

Variable	Rotophase protection control [2585]
Unit	-
Init value	0
List	0: Unused 1: Bus electrical fault 3: Alarm 4: Fault (soft shutdown) 9: Mains electrical fault
Description	Action performed on protection's trigger. Actions' description is available in the technical documentation.

Variable	Rotophase activation direction (0 = Indirect, 1 = Direct) [2584]
Unit	-
Init value	1
List	0: Indirect 1: Direct
Description	This setpoint define wich direction of rotophase will activate rotophase protection If the setpoint is on direct then the action of variables 2584 will activate if voltage phases are plugged on a direct direction. If the setpoint is on indirect then the action of variables 2584 will activate if voltage phases are plugged on an indirect direction.

Reverse kW/kVAR

Reverse kW

Variable	Reverse kW threshold [2518]
Unit	kW
Init value	100
Min value	0
Max value	32500
Description	Threshold to be exceeded to trigger the associated control for this protection.

Variable	Reverse kW timer [2519]
Unit	s
Init value	20.0
Min value	0.0
Max value	999.9
Description	Timer defining how long the value should exceed the treshold before triggering the control associated to this protection.

Variable	Reverse kW control [2520]
Unit	-
Init value	0
List	0: Unused 1: Bus electrical fault 3: Alarm 4: Fault (soft shutdown) 9: Mains electrical fault
Description	Action performed on protection's trigger. Actions' description is available in the technical documentation.

Reverse kVAR

Variable	Reverse kVAR threshold [2527]
Unit	kVAR
Init value	200
Min value	0
Max value	32500
Description	Threshold to be exceeded to trigger the associated control for this protection.

Variable	Reverse kVAR timer [2528]
Unit	s
Init value	20.0
Min value	0.0
Max value	999.9
Description	Timer defining how long the value should exceed the treshold before triggering the control associated to this protection.

Variable	Reverse kVAR control [2529]
Unit	-
Init value	0
List	0: Unused 1: Bus electrical fault 3: Alarm 4: Fault (soft shutdown) 9: Mains electrical fault
Description	Action performed on protection's trigger. Actions' description is available in the technical documentation.

Reverse kW 2

Variable	Reverse kW threshold 2 [2548]
Unit	kW
Init value	100
Min value	0
Max value	32500
Description	Threshold to be exceeded to trigger the associated control for this protection.

Variable	Reverse kW timer 2 [2549]
Unit	s
Init value	20.0
Min value	0.0
Max value	999.9
Description	Timer defining how long the value should exceed the treshold before triggering the control associated to this protection.

Variable	Reverse kW control 2 [2550]
Unit	-
Init value	0
List	0: Unused 1: Bus electrical fault 3: Alarm 4: Fault (soft shutdown) 9: Mains electrical fault
Description	Action performed on protection's trigger. Actions' description is available in the technical documentation.

Reverse kVAR 2

Variable	Reverse kVAR threshold 2 [2557]
Unit	kVAR
Init value	200
Min value	0
Max value	32500
Description	Threshold to be exceeded to trigger the associated control for this protection.

Variable	Reverse kVAR timer 2 [2558]
Unit	s
Init value	20.0
Min value	0.0
Max value	999.9
Description	Timer defining how long the value should exceed the treshold before triggering the control associated to this protection.

Variable	Reverse kVAR control 2 [2559]
Unit	-
Init value	0
List	0: Unused 1: Bus electrical fault 3: Alarm 4: Fault (soft shutdown) 9: Mains electrical fault
Description	Action performed on protection's trigger. Actions' description is available in the technical documentation.

Maximum/Minimum kW

Maximum kW

Variable	Maximum kW threshold [2515]
Unit	kW
Init value	110
Min value	0
Max value	32500
Description	Threshold to be exceeded to trigger the associated control for this protection.

Variable	Maximum kW timer [2516]
Unit	s
Init value	60.0
Min value	0.0
Max value	999.9
Description	Timer defining how long the value should exceed the treshold before triggering the control associated to this protection.

Variable	Maximum kW control [2517]
Unit	-
Init value	0
List	0: Unused 1: Bus electrical fault 3: Alarm 4: Fault (soft shutdown) 9: Mains electrical fault
Description	Action performed on protection's trigger. Actions' description is available in the technical documentation.

Minimum kW

Variable	Minimum kW threshold [2512]
Unit	kW
Init value	100
Min value	0
Max value	32500
Description	Threshold to be exceeded to trigger the associated control for this protection.

Variable	Minimum kW timer [2513]
Unit	s
Init value	120.0
Min value	0.0
Max value	999.9
Description	Timer defining how long the value should exceed the treshold before triggering the control associated to this protection.

Variable	Minimum kW control [2514]
Unit	-
Init value	0
List	0: Unused 1: Bus electrical fault 3: Alarm 4: Fault (soft shutdown) 9: Mains electrical fault
Description	Action performed on protection's trigger. Actions' description is available in the technical documentation.

Maximum kW 2

Variable	Maximum kW threshold 2 [2545]
Unit	kW
Init value	110
Min value	0
Max value	32500
Description	Threshold to be exceeded to trigger the associated control for this protection.

Variable	Maximum kW timer 2 [2546]
Unit	s
Init value	60.0
Min value	0.0
Max value	999.9
Description	Timer defining how long the value should exceed the treshold before triggering the control associated to this protection.

Variable	Maximum kW control 2 [2547]
Unit	-
Init value	0
List	0: Unused 1: Bus electrical fault 3: Alarm 4: Fault (soft shutdown) 9: Mains electrical fault
Description	Action performed on protection's trigger. Actions' description is available in the technical documentation.

Minimum kW 2

Variable	Minimum kW threshold 2 [2542]
Unit	kW
Init value	100
Min value	0
Max value	32500
Description	Threshold to be exceeded to trigger the associated control for this protection.

Variable	Minimum kW timer 2 [2543]
Unit	s
Init value	120.0
Min value	0.0
Max value	999.9
Description	Timer defining how long the value should exceed the treshold before triggering the control associated to this protection.

Variable	Minimum kW control 2 [2544]
Unit	-
Init value	0
List	0: Unused 1: Bus electrical fault 3: Alarm 4: Fault (soft shutdown) 9: Mains electrical fault
Description	Action performed on protection's trigger. Actions' description is available in the technical documentation.

Maxi kVAR/Mini kVAR

Maximum kVAR

Variable	Maximum kVAR threshold [2524]
Unit	kVAR
Init value	100
Min value	0
Max value	32500
Description	Threshold to be exceeded to trigger the associated control for this protection.

Variable	Maximum kVAR timer [2525]
Unit	s
Init value	30.0
Min value	0.0
Max value	999.9
Description	Timer defining how long the value should exceed the treshold before triggering the control associated to this protection.

Variable	Maximum kVAR control [2526]
Unit	-
Init value	0
List	0: Unused 1: Bus electrical fault 3: Alarm 4: Fault (soft shutdown) 9: Mains electrical fault
Description	Action performed on protection's trigger. Actions' description is available in the technical documentation.

Minimum kVar

Variable	Minimum kVAR threshold [2521]
Unit	kVAR
Init value	200
Min value	0
Max value	32500
Description	Threshold to be exceeded to trigger the associated control for this protection.

Variable	Minimum kVAR timer [2522]
Unit	s
Init value	120.0
Min value	0.0
Max value	999.9
Description	Timer defining how long the value should exceed the treshold before triggering the control associated to this protection.

Variable	Minimum kVAR control [2523]
Unit	-
Init value	0
List	0: Unused 1: Bus electrical fault 3: Alarm 4: Fault (soft shutdown) 9: Mains electrical fault
Description	Action performed on protection's trigger. Actions' description is available in the technical documentation.

Maximum kVAR 2

Variable	Maximum kVAR threshold 2 [2554]
Unit	kVAR
Init value	100
Min value	0
Max value	32500
Description	Threshold to be exceeded to trigger the associated control for this protection.

Variable	Maximum kVAR timer 2 [2555]
Unit	s
Init value	30.0
Min value	0.0
Max value	999.9
Description	Timer defining how long the value should exceed the treshold before triggering the control associated to this protection.

Variable	Maximum kVAR control 2 [2556]
Unit	-
Init value	0
List	0: Unused 1: Bus electrical fault 3: Alarm 4: Fault (soft shutdown) 9: Mains electrical fault
Description	Action performed on protection's trigger. Actions' description is available in the technical documentation.

Minimum kVar 2

Variable	Minimum kVAR threshold 2 [2551]
Unit	kVAR
Init value	200
Min value	0
Max value	32500
Description	Threshold to be exceeded to trigger the associated control for this protection.

Variable	Minimum kVAR timer 2 [2552]
Unit	s
Init value	120.0
Min value	0.0
Max value	999.9
Description	Timer defining how long the value should exceed the treshold before triggering the control associated to this protection.

Variable	Minimum kVAR control 2 [2553]
Unit	-
Init value	0
List	0: Unused 1: Bus electrical fault 3: Alarm 4: Fault (soft shutdown) 9: Mains electrical fault
Description	Action performed on protection's trigger. Actions' description is available in the technical documentation.

Vector jump/DF/DT

Vector jump

Variable	Vector jump threshold [2560]
Unit	°
Init value	20
Min value	1
Max value	30
Description	Threshold to be exceeded to trigger the associated control for this protection.

Variable	Vector jump control [2561]
Unit	-
Init value	0
List	0: Unused 1: Bus electrical fault 3: Alarm 4: Fault (soft shutdown) 9: Mains electrical fault
Description	Action performed on protection's trigger. Actions' description is available in the technical documentation.

DF/DT

Variable	df/dt threshold [2562]
Unit	Hz/s
Init value	1.0
Min value	0.1
Max value	10.0
Description	Threshold to be exceeded to trigger the associated control for this protection.

Variable	df/dt control [2563]
Unit	-
Init value	0
List	0: Unused 1: Bus electrical fault 3: Alarm 4: Fault (soft shutdown) 9: Mains electrical fault
Description	Action performed on protection's trigger. Actions' description is available in the technical documentation.

Init delay after mains paralleling

Variable	Vector jump and df/dt timer [2564]
Unit	s
Init value	2.0
Min value	0.0
Max value	6553.5
Description	Timer Initialisation after mains paralleling to activate Vector Jump and/or df/dt (Ro-cof) protections

OTHER PROTECTIONS

Analog inputs

Analog input 1

Variable	Analog input 1 threshold [2600]
Unit	bar
Init value	0.0
Min value	-3276.8
Max value	3276.7
Description	Threshold to be exceeded to trigger the associated control for this protection.

Variable	Analog input 1 timer [2601]
Unit	s
Init value	0.0
Min value	0.0
Max value	999.9
Description	Threshold to be exceeded to trigger the associated control for this protection.

Variable	Analog input 1 control [2602]
Unit	-
Init value	0
List	0: Unused 1: Bus electrical fault 2: Mains failure 3: Alarm 4: Fault (soft shutdown) 9: Mains electrical fault
Description	Action performed on protection's trigger. Actions' description is available in the technical documentation.

Variable	Analog input 1 threshold 2 [2603]
Unit	bar
Init value	0.0
Min value	-3276.8
Max value	3276.7
Description	Threshold to be exceeded to trigger the associated control for this protection.

Variable	Analog input 1 timer 2 [2604]
Unit	s
Init value	0.0
Min value	0.0
Max value	999.9
Description	Threshold to be exceeded to trigger the associated control for this protection.

Variable	Analog input 1 control 2 [2605]
Unit	-
Init value	0
List	0: Unused 1: Bus electrical fault 2: Mains failure 3: Alarm 4: Fault (soft shutdown) 9: Mains electrical fault
Description	Action performed on protection's trigger. Actions' description is available in the technical documentation.

Variable	Direction analog input 1 protection [2606]
Unit	-
Init value	0
List	0: Minimum 1: Maximum
Description	This setpoint define if the both threshold level for analog input 1 are minimum or maximum limit. If the setpoint is on "Minimum" then the action of variables 2602 and 2605 will activate from thresholds level set and below. If the setpoint is on "Maximum" then the action of variables 2602 and 2605 will activate from thresholds level set and above.

Analog input 2

Variable	Analog input 2 threshold [2608]
Unit	°C
Init value	0.0
Min value	-3276.8
Max value	3276.7
Description	Threshold to be exceeded to trigger the associated control for this protection.

OPERATOR MANUAL

Variable	Analog input 2 timer [2609]
Unit	s
Init value	0.0
Min value	0.0
Max value	999.9
Description	Threshold to be exceeded to trigger the associated control for this protection.

Variable	Analog input 2 control [2610]
Unit	-
Init value	0
List	0: Unused 1: Bus electrical fault 2: Mains failure 3: Alarm 4: Fault (soft shutdown) 9: Mains electrical fault
Description	Action performed on protection's trigger. Actions' description is available in the technical documentation.

Variable	Analog input 2 threshold 2 [2611]
Unit	°C
Init value	0.0
Min value	-3276.8
Max value	3276.7
Description	Threshold to be exceeded to trigger the associated control for this protection.

Variable	Analog input 2 timer 2 [2612]
Unit	s
Init value	0.0
Min value	0.0
Max value	999.9
Description	Threshold to be exceeded to trigger the associated control for this protection.

OPERATOR MANUAL

Variable	Analog input 2 control 2 [2613]
Unit	-
Init value	0
List	0: Unused 1: Bus electrical fault 2: Mains failure 3: Alarm 4: Fault (soft shutdown) 9: Mains electrical fault
Description	Action performed on protection's trigger. Actions' description is available in the technical documentation.

Variable	Direction analog input 2 protection [2614]
Unit	-
Init value	0
List	0: Minimum 1: Maximum
Description	This setpoint define if the both threshold level for analog input 2 are minimum or maximum limit. If the setpoint is on "Minimum" then the action of variables 2610 and 2613 will activate from thresholds level set and below. If the setpoint is on "Maximum" then the action of variables 2610 and 2613 will activate from thresholds level set and above.

Analog input 3

Variable	Analog input 3 threshold [2616]
Unit	-
Init value	0
Min value	-32768
Max value	32767
Description	Threshold to be exceeded to trigger the associated control for this protection.

Variable	Analog input 3 timer [2617]
Unit	s
Init value	0.0
Min value	0.0
Max value	999.9
Description	Threshold to be exceeded to trigger the associated control for this protection.

OPERATOR MANUAL

Variable	Analog input 3 control [2618]
Unit	-
Init value	0
List	0: Unused 1: Bus electrical fault 2: Mains failure 3: Alarm 4: Fault (soft shutdown) 9: Mains electrical fault
Description	Action performed on protection's trigger. Actions' description is available in the technical documentation.

Variable	Analog input 3 threshold 2 [2619]
Unit	-
Init value	0
Min value	-32768
Max value	32767
Description	Threshold to be exceeded to trigger the associated control for this protection.

Variable	Analog input 3 timer 2 [2620]
Unit	s
Init value	0.0
Min value	0.0
Max value	999.9
Description	Threshold to be exceeded to trigger the associated control for this protection.

Variable	Analog input 3 control 2 [2621]
Unit	-
Init value	0
List	0: Unused 1: Bus electrical fault 2: Mains failure 3: Alarm 4: Fault (soft shutdown) 9: Mains electrical fault
Description	Action performed on protection's trigger. Actions' description is available in the technical documentation.

Variable	Direction analog input 3 protection [2622]
Unit	-
Init value	0
List	0: Minimum 1: Maximum
Description	This setpoint define if the both threshold level for analog input 3 are minimum or maximum limit. If the setpoint is on "Minimum" then the action of vaiables 2618 and 2621 will activate from thresholds level set and below. If the setpoint is on "Maximum" then the action of vaiables 2618 and 2621 will activate from thresholds level set and above.

Battery

Maximum battery voltage

Variable	Max. voltage battery threshold [2359]
Unit	V
Init value	30.0
Min value	0.0
Max value	35.0
Description	Threshold to be exceeded to trigger the associated control for this protection.

Variable	Max. voltage battery timer [2360]
Unit	s
Init value	10.0
Min value	0.0
Max value	999.9
Description	Timer defining how long the value should exceed the treshold before triggering the control associated to this protection.

Variable	Max. voltage battery control [2361]
Unit	-
Init value	0
List	0: Unused 3: Alarm
Description	Action performed on protection's trigger. Actions' description is available in the technical documentation.

Minimum battery voltage

Variable	Min. voltage battery threshold [2356]
Unit	V
Init value	18.0
Min value	0.0
Max value	35.0
Description	Threshold to be exceeded to trigger the associated control for this protection.

Variable	Min. voltage battery timer [2357]
Unit	s
Init value	60.0
Min value	0.0
Max value	999.9
Description	Timer defining how long the value should exceed the treshold before triggering the control associated to this protection.

Variable	Min. voltage battery control [2358]
Unit	-
Init value	0
List	0: Unused 3: Alarm
Description	Action performed on protection's trigger. Actions' description is available in the technical documentation.

Maximum battery voltage 2

Variable	Max. voltage battery threshold 2 [2377]
Unit	V
Init value	32.0
Min value	0.0
Max value	35.0
Description	Threshold to be exceeded to trigger the associated control for this protection.

Variable	Max. voltage battery timer 2 [2378]
Unit	s
Init value	5.0
Min value	0.0
Max value	999.9
Description	Timer defining how long the value should exceed the treshold before triggering the control associated to this protection.

Variable	Max. voltage battery control 2 [2379]
Unit	-
Init value	0
List	0: Unused 3: Alarm
Description	Action performed on protection's trigger. Actions' description is available in the technical documentation.

Minimum battery voltage 2

Variable	Min. voltage battery threshold 2 [2374]
Unit	V
Init value	15.0
Min value	0.0
Max value	35.0
Description	Threshold to be exceeded to trigger the associated control for this protection.

Variable	Min. voltage battery timer 2 [2375]
Unit	s
Init value	10.0
Min value	0.0
Max value	999.9
Description	Timer defining how long the value should exceed the treshold before triggering the control associated to this protection.

Variable	Min. voltage battery control 2 [2376]
Unit	-
Init value	0
List	0: Unused 3: Alarm
Description	Action performed on protection's trigger. Actions' description is available in the technical documentation.

CAN 1

Variable	Control on controllers communication fault [3052]
Unit	-
Init value	3
List	0: Unused 3: Alarm 4: Fault (soft shutdown) 8: Droop Hz/V + Alarm
Description	Action performed on protection's trigger. Actions' description is available in the technical documentation.

Variable	Control on missing GENSYS COMPACT PRIME on CAN bus [3054]
Unit	-
Init value	3
List	0: Unused 3: Alarm 4: Fault (soft shutdown)
Description	Action performed on protection's trigger. Actions' description is available in the technical documentation.

Variable	Control on missing MASTER COMPACT/BTB COMPACT on CAN bus [3057]
Unit	-
Init value	3
List	0: Unused 3: Alarm 4: Fault (soft shutdown)
Description	Action performed on protection's trigger. Actions' description is available in the technical documentation.

OPERATOR MANUAL

Variable	Control on missing HYBRID COMPACT on CAN bus [3060]
Unit	-
Init value	3
List	0: Unused 3: Alarm 4: Fault (soft shutdown)
Description	Action performed on protection's trigger. Actions' description is available in the technical documentation.

Variable	Control on missing BAT COMPACT on CAN bus [3061]
Unit	-
Init value	3
List	0: Unused 3: Alarm 4: Fault (soft shutdown)
Description	Action performed on protection's trigger. Actions' description is available in the technical documentation.

Variable	Control on not enough genset available [2399]
Unit	-
Init value	3
List	0: Unused 3: Alarm
Description	Action performed on protection's trigger. Actions' description is available in the technical documentation.

CANopen

Variable	Control on CANopen error [3059]
Unit	-
Init value	3
List	0: Unused 3: Alarm 4: Fault (soft shutdown)
Description	Action performed on protection's trigger. Actions' description is available in the technical documentation.

Variable	CANopen error timer [3152]
Unit	s
Init value	10.0
Min value	0.0
Max value	6553.5
Description	CANopen error timer

Mismatch rotophase

Variable	Mismatch rotophases protection control [2397]
Unit	-
Init value	0
List	0: Unused 1: Bus electrical fault 3: Alarm 4: Fault (soft shutdown)
Description	Action performed on protection's trigger. Actions' description is available in the technical documentation.

PROGRAMMING

HYSTERESIS

Hysteresis 1

Variable	Enable Hysteresis 1 [2657]
Unit	-
Init value	0
List	0: No 1: Yes
Description	Enable hysteresis on analog input 1 with thresholds E2660 (Low Level) & E2663 (High Level)

Variable	Low level threshold [2660]
Unit	bar
Init value	0.0
Min value	-3276.8
Max value	3276.7
Description	Low level threshold for digital output activation on hysteresis 1

Variable	Timer on low level threshold [2666]
Unit	s
Init value	3.0
Min value	0.0
Max value	999.9
Description	Timer before set/reset digital output on hysteresis low threshold 1

Variable	High level threshold [2663]
Unit	bar
Init value	0.0
Min value	-3276.8
Max value	3276.7
Description	High level threshold for digital output activation on hysteresis 1

Variable	Timer on high level threshold [2669]
Unit	s
Init value	3.0
Min value	0.0
Max value	999.9
Description	Timer before set/reset digital output on hysteresis high threshold 1

Variable	Hysteresis Direction 1 [2672]
Unit	-
Init value	0
List	0: Set on low threshold, reset on high threshold 1: Set on high threshold, reset on low threshold
Description	Hysteresis 1 Direction (0 : Set on low thresh. - Reset on high thresh. / 1 : Set on high thresh. - Reset on low thresh)

Hysteresis 2

Variable	Enable Hysteresis 2 [2658]
Unit	-
Init value	0
List	0: No 1: Yes
Description	Enable hysteresis on analog input 2 with thresholds E2661 (Low Level) & E2664 (High Level)

Variable	Low level threshold [2661]
Unit	°C
Init value	0.0
Min value	-3276.8
Max value	3276.7
Description	Low level threshold for digital output activation on hysteresis 2

OPERATOR MANUAL

Variable	Timer on low level threshold [2667]
Unit	s
Init value	3.0
Min value	0.0
Max value	999.9
Description	Timer before set/reset digital output on hysteresis low threshold 2

Variable	High level threshold [2664]
Unit	°C
Init value	0.0
Min value	-3276.8
Max value	3276.7
Description	High level threshold for digital output activation on hysteresis 2

Variable	Timer on high level threshold [2670]
Unit	s
Init value	3.0
Min value	0.0
Max value	999.9
Description	Timer before set/reset digital output on hysteresis high threshold 2

Variable	Hysteresis Direction 2 [2673]
Unit	-
Init value	0
List	0: Set on low threshold, reset on high threshold 1: Set on high threshold, reset on low threshold
Description	Hysteresis 2 Direction (0 : Set on low thresh. - Reset on high thresh. / 1 : Set on high thresh. - Reset on low thresh)

Hysteresis 3

Variable	Enable Hysteresis 3 [2659]
Unit	-
Init value	0
List	0: No 1: Yes
Description	Enable hysteresis on analog input 3 with thresholds E2662 (Low Level) & E2665 (High Level)

Variable	Low level threshold [2662]
Unit	-
Init value	0
Min value	-32768
Max value	32767
Description	Low level threshold for digital output activation on hysteresis 3

Variable	Timer on low level threshold [2668]
Unit	s
Init value	3.0
Min value	0.0
Max value	999.9
Description	Timer before set/reset digital output on hysteresis low threshold 3

Variable	High level threshold [2665]
Unit	-
Init value	0
Min value	-32768
Max value	32767
Description	High level threshold for digital output activation on hysteresis 3

Variable	Timer on high level threshold [2671]
Unit	s
Init value	3.0
Min value	0.0
Max value	999.9
Description	Timer before set/reset digital output on hysteresis high threshold 3

OPERATOR MANUAL

Variable	Hysteresis Direction 3 [2674]
Unit	-
Init value	0
List	0: Set on low threshold, reset on high threshold 1: Set on high threshold, reset on low threshold
Description	Hysteresis 3 Direction (0 : Set on low thresh. - Reset on high thresh. / 1 : Set on high thresh. - Reset on low thresh)

MODBUS

Connection settings

Variable	Enable connection to Modbus server [3031]
Unit	-
Init value	0
List	0: No 1: Yes
Description	Enable connection to a Modbus server for custom read/write requests

Variable	Control on Modbus server timeouts [3030]
Unit	-
Init value	3
List	0: Unused 3: Alarm 4: Fault (soft shutdown)
Description	Control on TCP connection loss or frame timeout with Modbus server

Variable	Modbus server frame timeout [3032]
Unit	s
Init value	5.0
Min value	0.0
Max value	6553.5
Description	Timeout in ms for no response to a frame emitted from the Modbus server

Modbus rights

Variable	Write date/time [3015.0]
Description	-

Variable	Write engine meters [3015.1]
Description	-

Variable	Write input functions [3015.3]
Description	-

OPERATOR MANUAL

Variable	Reading via Modbus TCP [3015.8]
Description	-

Variable	Writing via Modbus TCP [3015.9]
Description	-

LOGGER

Activation

Variable	Activation [3610]
Unit	-
Init value	0
List	0: Off 1: Always ON 2: Post starting 3: Stabilized
Description	Archiving mode OFF = NEVER / ALWAYS / POST STARTING / STABILIZED, event archiving can be activated depending on engine status. Warning: erase will delete all faults, alarms and archived data.

Variables 1-5

Log 1

Variable	Variable 1 to log [3600]
Unit	-
Init value	0
Min value	0
Max value	10299
Description	Logger of the variable to archive

Variable	Log variable 1 on [3622]
Unit	-
Init value	0
List	0: Value change 1: Interval
Description	A variable can be logged in two different ways: - Interval: The variable will be logged at specific intervals, defined by the user ([3612]) - Value change: The variable will be logged each time the value of the variable has been changed

Variable	Logging period variable 1 [3612]
Unit	s
Init value	1
Min value	1
Max value	9999
Description	Time in second of interval between each archiving

Log 2

Variable	Variable 2 to log [3601]
Unit	-
Init value	0
Min value	0
Max value	10299
Description	Logger of the variable to archive

Variable	Log variable 2 on [3623]
Unit	-
Init value	0
List	0: Value change 1: Interval
Description	A variable can be logged in two different ways: - Interval: The variable will be logged at a periodic interval, defined by the user ([3613]) - Value change: The variable will be logged each time the value of the variable has been changed

Variable	Logging period variable 2 [3613]
Unit	s
Init value	1
Min value	1
Max value	9999
Description	Time in second of interval between each archiving

Log 3

Variable	Variable 3 to log [3602]
Unit	-
Init value	0
Min value	0
Max value	10299
Description	Logger of the variable to archive

Variable	Log variable 3 on [3624]
Unit	-
Init value	0
List	0: Value change 1: Interval
Description	A variable can be logged in two different ways: - Interval: The variable will be logged at a periodic interval, defined by the user ([3614]) - Value change: The variable will be logged each time the value of the variable has been changed

Variable	Logging period variable 3 [3614]
Unit	s
Init value	1
Min value	1
Max value	9999
Description	Time in second of interval between each archiving

Log 4

Variable	Variable 4 to log [3603]
Unit	-
Init value	0
Min value	0
Max value	10299
Description	Logger of the variable to archive

Variable	Log variable 4 on [3625]
Unit	-
Init value	0
List	0: Value change 1: Interval
Description	A variable can be logged in two different ways: - Interval: The variable will be logged at a periodic interval, defined by the user ([3615]) - Value change: The variable will be logged each time the value of the variable has been changed

Variable	Logging period variable 4 [3615]
Unit	s
Init value	1
Min value	1
Max value	9999
Description	Time in second of interval between each archiving

Log 5

Variable	Variable 5 to log [3604]
Unit	-
Init value	0
Min value	0
Max value	10299
Description	Logger of the variable to archive

Variable	Log variable 5 on [3626]
Unit	-
Init value	0
List	0: Value change 1: Interval
Description	A variable can be logged in two different ways: - Interval: The variable will be logged at a periodic interval, defined by the user ([3616]) - Value change: The variable will be logged each time the value of the variable has been changed

Variable	Logging period variable 5 [3616]
Unit	s
Init value	1
Min value	1
Max value	9999
Description	Time in second of interval between each archiving

Variables 6-10

Log 6

Variable	Variable 6 to log [3605]
Unit	-
Init value	0
Min value	0
Max value	10299
Description	Logger of the variable to archive

Variable	Log variable 6 on [3627]
Unit	-
Init value	0
List	0: Value change 1: Interval
Description	A variable can be logged in two different ways: - Interval: The variable will be logged at a periodic interval, defined by the user ([3617]) - Value change: The variable will be logged each time the value of the variable has been changed

Variable	Logging period variable 6 [3617]
Unit	s
Init value	1
Min value	1
Max value	9999
Description	Time in second of interval between each archiving

Log 7

Variable	Variable 7 to log [3606]
Unit	-
Init value	0
Min value	0
Max value	10299
Description	Logger of the variable to archive

Variable	Log variable 7 on [3628]
Unit	-
Init value	0
List	0: Value change 1: Interval
Description	A variable can be logged in two different ways: - Interval: The variable will be logged at a periodic interval, defined by the user ([3618]) - Value change: The variable will be logged each time the value of the variable has been changed

Variable	Logging period variable 7 [3618]
Unit	s
Init value	1
Min value	1
Max value	9999
Description	Time in second of interval between each archiving

Log 8

Variable	Variable 8 to log [3607]
Unit	-
Init value	0
Min value	0
Max value	10299
Description	Logger of the variable to archive

Variable	Log variable 8 on [3629]
Unit	-
Init value	0
List	0: Value change 1: Interval
Description	A variable can be logged in two different ways: - Interval: The variable will be logged at a periodic interval, defined by the user ([3619]) - Value change: The variable will be logged each time the value of the variable has been changed

Variable	Logging period variable 8 [3619]
Unit	s
Init value	1
Min value	1
Max value	9999
Description	Time in second of interval between each archiving

Log 9

Variable	Variable 9 to log [3608]
Unit	-
Init value	0
Min value	0
Max value	10299
Description	Logger of the variable to archive

Variable	Log variable 9 on [3630]
Unit	-
Init value	0
List	0: Value change 1: Interval
Description	A variable can be logged in two different ways: - Interval: The variable will be logged at a periodic interval, defined by the user ([3620]) - Value change: The variable will be logged each time the value of the variable has been changed

Variable	Logging period variable 9 [3620]
Unit	s
Init value	1
Min value	1
Max value	9999
Description	Time in second of interval between each archiving

Log 10

Variable	Variable 10 to log [3609]
Unit	-
Init value	0
Min value	0
Max value	10299
Description	Logger of the variable to archive

Variable	Log variable 10 on [3631]
Unit	-
Init value	0
List	0: Value change 1: Interval
Description	A variable can be logged in two different ways: - Interval: The variable will be logged at a periodic interval, defined by the user ([3621]) - Value change: The variable will be logged each time the value of the variable has been changed

Variable	Logging period variable 10 [3621]
Unit	s
Init value	1
Min value	1
Max value	9999
Description	Time in second of interval between each archiving

SYSTEM

LCD DISPLAY

Screen saving

Variable	Screensaver timeout [3551]
Unit	min
Init value	5
Min value	0
Max value	120
Description	Timeout Screen saver (0=infini)

Backlight

Variable	Backlight timeout [3552]
Unit	min
Init value	5
Min value	0
Max value	120
Description	Timeout Backlight (0=infini)

Variable	LCD screen backlight [3555]
Unit	%
Init value	100
Min value	0
Max value	100
Description	LCD backlight intensity

Variable	LCD screen contrast [3554]
Unit	%
Init value	50
Min value	0
Max value	100
Description	LCD contrast intensity

DATE/TIME

Variable	Day of the week [10]
Unit	-
Init value	0
Min value	0
Max value	6
Description	Day of the week (RTC)

Variable	Day [11]
Unit	days
Init value	0
Min value	1
Max value	31
Description	Day (RTC)

Variable	Month [12]
Unit	-
Init value	0
Min value	1
Max value	12
Description	Month (RTC)

Variable	Year [13]
Unit	-
Init value	0
Min value	0
Max value	99
Description	Year (RTC)

Variable	Hours [14]
Unit	h
Init value	0
Min value	0
Max value	23
Description	Hours (RTC)

OPERATOR MANUAL

Variable	Minutes [15]
Unit	min
Init value	0
Min value	0
Max value	59
Description	Minutes (RTC)

BUTTONS INHIBITION

Variable	Auto button inhibition [8102.14]
Description	Allows to disable (1) or enable (0) the button

Variable	Test button inhibition [8102.13]
Description	Allows to disable (1) or enable (0) the button

Variable	Man button inhibition [8102.12]
Description	Allows to disable (1) or enable (0) the button

Variable	Start button inhibition [8102.11]
Description	Allows to disable (1) or enable (0) the button

Variable	Stop button inhibition [8102.10]
Description	Allows to disable (1) or enable (0) the button

Variable	Bus breaker button inhibition [8102.9]
Description	Allows to disable (1) or enable (0) the button

Variable	Mains breaker button inhibition [8102.8]
Description	Allows to disable (1) or enable (0) the button

Variable	Fault/Alarm/info button inhibition [8102.7]
Description	Allows to disable (1) or enable (0) the button

Variable	Esc button inhibition [8102.6]
Description	Allows to disable (1) or enable (0) the button

Variable	Enter button inhibition [8102.5]
Description	Allows to disable (1) or enable (0) the button

OPERATOR MANUAL

Variable	Up arrow button inhibition [8102.4]
Description	Allows to disable (1) or enable (0) the button

Variable	Left arrow button inhibition [8102.3]
Description	Allows to disable (1) or enable (0) the button

Variable	Down arrow button inhibition [8102.2]
Description	Allows to disable (1) or enable (0) the button

Variable	Right arrow button inhibition [8102.1]
Description	Allows to disable (1) or enable (0) the button

Variable	Shift button inhibition [8102.0]
Description	Allows to disable (1) or enable (0) the button

LIST OF INPUTS

BUS

Variable	Bus breaker feedback [4501]
Description	Breaker position feedback, when active the breaker is considered closed.

Variable	Remote start on load [4502]
Description	Activation starts the generator(s) in automatic mode, and the bus circuit breaker closes on the load.

Variable	Remote start off load [4611]
Description	Activation will start generator(s) in automatic mode and keep breaker open: used for off load tests.

Variable	Remote start with timer [4612]
Description	Activation starts the generator(s) in automatic mode and waits for an adjustable delay until the generator(s) are ready before closing the circuit breaker. Used to extend the start sequence and preheat the generator(s) at nominal frequency.

Variable	Power plant ready [4636]
Description	Used for external validation of 'generator power plant ready': Activation will declare all generators as ready to provide load if frequency and voltage are stabilized.

MAINS

Variable	Mains breaker feedback [4500]
Description	Mains breaker position feedback. when active the mains breaker is considered closed.

Variable	Manual mains back [4544]
Description	When configured, the sequence to switch back on Mains after generator start on Mains failure will be on hold until this input is activated. Load will remain on generator even if Mains back timer is elapsed, input will be mandatory to come back on Mains power.

Variable	Mains failure [4638]
Description	Mains failure. will consider Mains as not valid and request generator to start on load. Mains back timer will run once input is off, timer is adjustable in Timer settings. Mains failure will be logged as an event.

Variable	Mains available [4642]
Description	External signal to simulate Mains as available. Mains LED will lit when input is activated.

INPUTS/OUTPUTS

Variable	Digital output 1 forced [4630]
Description	Activating this input will force activation of digital ouput 1.

Variable	Digital output 2 forced [4631]
Description	Activating this input will force activation of digital ouput 2.

Variable	Digital output 3 forced [4632]
Description	Activating this input will force activation of digital ouput 3.

Variable	Digital output 4 forced [4633]
Description	Activating this input will force activation of digital ouput 4.

Variable	Digital output 5 forced [4634]
Description	Activating this input will force activation of digital ouput 5.

Variable	Digital output 6 forced [4635]
Description	Activating this input will force activation of digital ouput 6.

Variable	Relay 1 forced [4950]
Description	Activating this input will force activation of relay ouput 1.

Variable	Relay 2 forced [4951]
Description	Activating this input will force activation of relay ouput 2.

POWER PLANT

Variable	External non essential trip request [4537]
Description	External activation of the load shedding protection outputs. Use only if load shedding is enable.

ALARMS/FAULTS

Variable	Emergency stop [4505]
Description	Emergency stop activation: Will immediately stop the generator(s) and force circuit breaker open.

Variable	Bus fault request (Trip) [4507]
Description	<p>External electrical fault : Activation opens the circuit-breaker and keeps it open. After an adjustable delay (circuit-breaker menu/Delay before new attempt), a new attempt will be performed to close the circuit-breaker.</p> <p>The maximum number of attempts can be set in breaker settings (number of closing attempts).</p> <p>If the fault is still present after the last attempt, the circuit-breaker will open and the system will stop on fault.</p>

Variable	Mains fault request [4508]
Description	<p>External electrical fault : Activation will trip the Mains circuit breaker, and after an adjustable timer (breaker menu/Delay before new attempt), a new attempts of running Mains circuit breaker closed on load will be effective.</p> <p>The number of attempts is adjustable in breaker settings (number of closing attempts), if the fault is still present after the last attempt, Mains breaker will remain on fault. Remote start to generator is not provided in this case, only 'Mains failure' function will provide generator start request.</p>

Variable	Remote soft shut down [4526]
Description	Immediate opening of bus circuit breaker and stop of generators after cooling down, activated by external command.

Variable	Remote alarm [4527]
Description	Alarm only - non critical event activated by external device - Orange led is displayed an event logged.

ALTERNATIVE SELECTIONS

Variable	Alternative selection 1 [4594]
Description	Available variable to toggle a parameter between 2 values. See Alternative selection function.

Variable	Alternative selection 2 [4595]
Description	Available variable to toggle a parameter between 2 values. See Alternative selection function.

Variable	Alternative selection 3 [4596]
Description	Available variable to toggle a parameter between 2 values. See Alternative selection function.

Variable	Alternative selection 4 [4597]
Description	Available variable to toggle a parameter between 2 values. See Alternative selection function.

Variable	Alternative selection 5 [4598]
Description	Available variable to toggle a parameter between 2 values. See Alternative selection function.

Variable	Alternative selection 6 [4599]
Description	Available variable to toggle a parameter between 2 values. See Alternative selection function.

Variable	Alternative selection 7 [4600]
Description	Available variable to toggle a parameter between 2 values. See Alternative selection function.

Variable	Alternative selection 8 [4601]
Description	Available variable to toggle a parameter between 2 values. See Alternative selection function.

Variable	Alternative selection 9 [4602]
Description	Available variable to toggle a parameter between 2 values. See Alternative selection function.

OPERATOR MANUAL

Variable	Alternative selection 10 [4603]
Description	Available variable to toggle a parameter between 2 values. See Alternative selection function.

Variable	Alternative selection 11 [4604]
Description	Available variable to toggle a parameter between 2 values. See Alternative selection function.

Variable	Alternative selection 12 [4605]
Description	Available variable to toggle a parameter between 2 values. See Alternative selection function.

Variable	Alternative selection 13 [4606]
Description	Available variable to toggle a parameter between 2 values. See Alternative selection function.

Variable	Alternative selection 14 [4607]
Description	14th available variable to switch a parameter between 2 values

Variable	Alternative selection 15 [4608]
Description	15th available variable to switch a parameter between 2 values

Variable	Alternative selection 16 [4609]
Description	16th available variable to switch a parameter between 2 values

HYSTERESIS

Variable	Hysteresis low threshold DI1 [4614]
Description	Activate to trigger the corresponding hysteresis low threshold.

Variable	Hysteresis low threshold DI2 [4615]
Description	Activate to trigger the corresponding hysteresis low threshold.

Variable	Hysteresis low threshold DI3 [4616]
Description	Activate to trigger the corresponding hysteresis low threshold.

Variable	Hysteresis low threshold DI4 [4617]
Description	Activate to trigger the corresponding hysteresis low threshold.

Variable	Hysteresis low threshold DI5 [4618]
Description	Activate to trigger the corresponding hysteresis low threshold.

Variable	Hysteresis low threshold DI6 [4619]
Description	Activate to trigger the corresponding hysteresis low threshold.

Variable	Hysteresis low threshold DI7 [4620]
Description	Activate to trigger the corresponding hysteresis low threshold.

Variable	Hysteresis low threshold DI8 [4621]
Description	Activate to trigger the corresponding hysteresis low threshold.

Variable	Hysteresis high threshold DI1 [4622]
Description	Activate to trigger the corresponding hysteresis high threshold.

Variable	Hysteresis high threshold DI2 [4623]
Description	Activate to trigger the corresponding hysteresis high threshold.

OPERATOR MANUAL

Variable	Hysteresis high threshold DI3 [4624]
Description	Activate to trigger the corresponding hysteresis high threshold.

Variable	Hysteresis high threshold DI4 [4625]
Description	Activate to trigger the corresponding hysteresis high threshold.

Variable	Hysteresis high threshold DI5 [4626]
Description	Activate to trigger the corresponding hysteresis high threshold.

Variable	Hysteresis high threshold DI6 [4627]
Description	Activate to trigger the corresponding hysteresis high threshold.

Variable	Hysteresis high threshold DI7 [4628]
Description	Activate to trigger the corresponding hysteresis high threshold.

Variable	Hysteresis high threshold DI8 [4629]
Description	Activate to trigger the corresponding hysteresis high threshold.

REMOTE BUTTONS

Variable	Remote faults reset [4506]
Description	External reset. Acknowledgement of alarm/fault present in display pages (same action as shift+I reset).

Variable	Manual start request [4509]
Description	Manual start command (alternative to front panel push button). Active in manual mode only.

Variable	Manual stop request [4510]
Description	Manual stop command (alternative to front panel push button). Active in manual mode only.

Variable	Manual mode request [4511]
Description	Force controller in manual mode, same effect as MAN button.

Variable	Manual mode inhibition [4512]
Description	Prevent controller to go in manual mode (Remotely or front panel).

Variable	Auto mode request [4513]
Description	Force controller in auto mode, same effect as AUTO button.

Variable	Bus breaker opening in manual mode [4518]
Description	Remote manual opening of bus breaker in manual mode (alternative to front button). Active in manual mode only.

Variable	Mains breaker opening in manual mode [4519]
Description	Remote manual opening of mains breaker in manual mode (alternative to front button). Active in manual mode only.

Variable	Bus breaker closing in manual mode [4520]
Description	Manual request to close bus breaker (alternative to front panel buttons). Active in manual mode only.

OPERATOR MANUAL

Variable	Mains breaker closing in manual mode [4521]
Description	Remote manual close of mains breaker in manual mode (alternative to front button). Active in manual mode only.

Variable	Stop horn [4530]
Description	External horn stop request. Used when Horn output is configured.

Variable	Led test [4580]
Description	Activates all LEDs of the module in order to check that the LEDs work

Variable	Test mode request [4590]
Description	Force controller in test mode, same effect as TEST button.

LIST OF OUTPUTS

COMMANDS

Variable	Horn [4663]
Description	External horn or warning light. Activated whenever a fault/alarm triggers. The output is disable on acknowledgment or reset. Horn timer is adjustable in timer menu (0s = permanent activation).

Variable	Bus breaker closure [4675]
Description	Command to close the breaker. Output signal (pulse or continue) will depend on configuration in Breaker settings.

Variable	Mains breaker close [4676]
Description	Command to close the breaker. Output signal (pulse or continue) will depend on configuration in Breaker settings.

Variable	Bus breaker opening [4677]
Description	Command to open the breaker. Output signal (pulse or continue) will depend on configuration in Breaker settings.

Variable	Mains breaker open [4678]
Description	Command to open the breaker. Output signal (pulse or continue) will depend on configuration in Breaker settings.

Variable	1st non essential trip [4689]
Description	In case Load Shedding function is used: Load 1 to be shed in first

Variable	2nd non essential trip [4690]
Description	In case Load Shedding function is used: Load 2 to be shed after load 1

Variable	3rd non essential trip [4691]
Description	In case Load Shedding function is used: Load 3 to be shed after load 2

Variable	4th non essential trip [4692]
Description	In case Load Shedding function is used: Load 4 to be shed after load 3

OPERATOR MANUAL

Variable	5th non essential trip [4693]
Description	In case Load Shedding function is used: Load 5 to be shed after load 4

Variable	Unload breaker n°1 [4721]
Description	Use only with 'Unload breakers function'. Output function activated when the conditions to close the breaker of the load n°1 are met

Variable	Unload breaker n°2 [4722]
Description	Use only with 'Unload breakers function'. Output function activated when the conditions to close the breaker of the load n°2 are met

Variable	Unload breaker n°3 [4723]
Description	Use only with 'Unload breakers function'. Output function activated when the conditions to close the breaker of the load n°3 are met

Variable	Unload breaker n°4 [4724]
Description	Use only with 'Unload breakers function'. Output function activated when the conditions to close the breaker of the load n°4 are met

Variable	Unload breaker n°5 [4725]
Description	Use only with 'Unload breakers function'. Output function activated when the conditions to close the breaker of the load n°5 are met

Variable	Unload breaker n°6 [4726]
Description	Use only with 'Unload breakers function'. Output function activated when the conditions to close the breaker of the load n°6 are met

Variable	Unload breaker n°7 [4727]
Description	Use only with 'Unload breakers function'. Output function activated when the conditions to close the breaker of the load n°7 are met

Variable	Unload breaker n°8 [4728]
Description	Use only with 'Unload breakers function'. Output function activated when the conditions to close the breaker of the load n°8 are met

OPERATOR MANUAL

Variable	Unload breaker n°9 [4729]
Description	Use only with 'Unload breakers function'. Output function activated when the conditions to close the breaker of the load n°9 are met

Variable	Unload breaker n°10 [4730]
Description	Use only with 'Unload breakers function'. Output function activated when the conditions to close the breaker of the load n°10 are met

Variable	Faults reset [4737]
Description	Active when a Fault RESET is requested on controller.

BUS

Variable	Fail to close bus breaker [4154]
Description	Fault report: The automated system tried to close the circuit breaker without success

Variable	Fail to open bus breaker [4155]
Description	Fault report: The automated system tried to open the circuit breaker without success

Variable	Bus breaker open suddenly [4156]
Description	Fault report: The circuit breaker has opened without any request for opening from the automated system

Variable	Bus breaker close suddenly [4170]
Description	Fault report: The circuit breaker has closed without any request for closing from the automated system

Variable	Bus breaker state [4650]
Description	Status report: Gives the state desired by the automated system for the circuit breaker (0: opening / 1: closing). Not to be confused with the closing command, whose behaviour depends on the configuration (Contact, Impulse, etc).

Variable	Power plant ready [4670]
Description	Status report: Power plant ready. All generators are providing stable frequency and voltage on the bus.

Variable	Power plant ready and breaker closed [4672]
Description	Status report: Active if generator(s) are producing

MAINS

Variable	Fail to close mains breaker [4157]
Description	Fault report: The automated system tried to close the circuit breaker without success

Variable	Fail to open mains breaker [4158]
Description	Fault report: The automated system tried to open the circuit breaker without success

Variable	Mains breaker open suddenly [4159]
Description	Fault report: The circuit breaker has opened without any request for opening from the automated system

Variable	Mains breaker close suddenly [4171]
Description	Fault report: The circuit breaker has closed without any request for closing from the automated system

Variable	Mains breaker state [4651]
Description	Status report: Gives the state desired by the automated system for the circuit breaker (0: opening / 1: closing). Not to be confused with the closing command, whose behaviour depends on the configuration (Contact, Impulse, etc).

Variable	Bus/Mains voltage presence [4703]
Description	Status report: Activated when mains is present, and valid (i.e after mains back delay [2009] occurred) and no mains electrical fault activated.

INPUTS/OUTPUTS

Variable	Input 1 (Customisable) [250]
Description	<p>Digital input n°1 of the product. Select a normally open polarity if the input is connected to 0V when the input should be considered active. Select a normally closed polarity if the input is connected to 0V when the input must be considered inactive. The validity indicates when the digital input should be taken into account. The T ON delay allows you to add a delay between the moment when the digital input is physically activated and the moment when the product considers it active for the automated system. The T OFF time delay allows you to add a delay between the moment when the digital input is physically disabled and the moment when the product considers it inactive for the automated system.</p>

Variable	Input 2 (Customisable) [251]
Description	<p>Digital input n°2 of the product. Select a normally open polarity if the input is connected to 0V when the input should be considered active. Select a normally closed polarity if the input is connected to 0V when the input must be considered inactive. The validity indicates when the digital input should be taken into account. The T ON delay allows you to add a delay between the moment when the digital input is physically activated and the moment when the product considers it active for the automated system. The T OFF time delay allows you to add a delay between the moment when the digital input is physically disabled and the moment when the product considers it inactive for the automated system.</p>

Variable	Input 3 (Customisable) [252]
Description	<p>Digital input n°3 of the product. Select a normally open polarity if the input is connected to 0V when the input should be considered active. Select a normally closed polarity if the input is connected to 0V when the input must be considered inactive. The validity indicates when the digital input should be taken into account. The T ON delay allows you to add a delay between the moment when the digital input is physically activated and the moment when the product considers it active for the automated system. The T OFF time delay allows you to add a delay between the moment when the digital input is physically disabled and the moment when the product considers it inactive for the automated system.</p>

OPERATOR MANUAL

Variable	Input 4 (Customisable) [253]
Description	<p>Digital input n°4 of the product.</p> <p>Select a normally open polarity if the input is connected to 0V when the input should be considered active.</p> <p>Select a normally closed polarity if the input is connected to 0V when the input must be considered inactive.</p> <p>The validity indicates when the digital input should be taken into account.</p> <p>The T ON delay allows you to add a delay between the moment when the digital input is physically activated and the moment when the product considers it active for the automated system.</p> <p>The T OFF time delay allows you to add a delay between the moment when the digital input is physically disabled and the moment when the product considers it inactive for the automated system.</p>

Variable	Input 5 (Customisable) [254]
Description	<p>Digital input n°5 of the product.</p> <p>Select a normally open polarity if the input is connected to 0V when the input should be considered active.</p> <p>Select a normally closed polarity if the input is connected to 0V when the input must be considered inactive.</p> <p>The validity indicates when the digital input should be taken into account.</p> <p>The T ON delay allows you to add a delay between the moment when the digital input is physically activated and the moment when the product considers it active for the automated system.</p> <p>The T OFF time delay allows you to add a delay between the moment when the digital input is physically disabled and the moment when the product considers it inactive for the automated system.</p>

Variable	Input 6 (Customisable) [255]
Description	<p>Digital input n°6 of the product.</p> <p>Select a normally open polarity if the input is connected to 0V when the input should be considered active.</p> <p>Select a normally closed polarity if the input is connected to 0V when the input must be considered inactive.</p> <p>The validity indicates when the digital input should be taken into account.</p> <p>The T ON delay allows you to add a delay between the moment when the digital input is physically activated and the moment when the product considers it active for the automated system.</p> <p>The T OFF time delay allows you to add a delay between the moment when the digital input is physically disabled and the moment when the product considers it inactive for the automated system.</p>

OPERATOR MANUAL

Variable	Input 7 (Customisable) [256]
Description	<p>Digital input n°7 of the product. Select a normally open polarity if the input is connected to 0V when the input should be considered active. Select a normally closed polarity if the input is connected to 0V when the input must be considered inactive. The validity indicates when the digital input should be taken into account. The T ON delay allows you to add a delay between the moment when the digital input is physically activated and the moment when the product considers it active for the automated system. The T OFF time delay allows you to add a delay between the moment when the digital input is physically disabled and the moment when the product considers it inactive for the automated system.</p>

Variable	Input 8 (Customisable) [257]
Description	<p>Digital input n°8 of the product. Select a normally open polarity if the input is connected to 0V when the input should be considered active. Select a normally closed polarity if the input is connected to 0V when the input must be considered inactive. The validity indicates when the digital input should be taken into account. The T ON delay allows you to add a delay between the moment when the digital input is physically activated and the moment when the product considers it active for the automated system. The T OFF time delay allows you to add a delay between the moment when the digital input is physically disabled and the moment when the product considers it inactive for the automated system.</p>

Variable	Input 9 (Customisable) [258]
Description	<p>Digital input n°9 of the product. Select a normally open polarity if the input is connected to 0V when the input should be considered active. Select a normally closed polarity if the input is connected to 0V when the input must be considered inactive. The validity indicates when the digital input should be taken into account. The T ON delay allows you to add a delay between the moment when the digital input is physically activated and the moment when the product considers it active for the automated system. The T OFF time delay allows you to add a delay between the moment when the digital input is physically disabled and the moment when the product considers it inactive for the automated system.</p>

Variable	Analog 1 (Customisable) [259]
Description	Digital input 10 (Analog1 set as Digital input)

Variable	Analog 2 (Customisable) [260]
Description	Digital input 11 (Analog2 set as Digital input)

OPERATOR MANUAL

Variable	Analog 3 (Customisable) [261]
Description	Digital input 12 (Analog3 set as Digital input)

Variable	Physical status of digital input 1 [953.0]
Description	Physical state of the digital input (without application of polarity, validity and time delays)

Variable	Physical status of digital input 2 [953.1]
Description	Physical state of the digital input (without application of polarity, validity and time delays)

Variable	Physical status of digital input 3 [953.2]
Description	Physical state of the digital input (without application of polarity, validity and time delays)

Variable	Physical status of digital input 4 [953.3]
Description	Physical state of the digital input (without application of polarity, validity and time delays)

Variable	Physical status of digital input 5 [953.4]
Description	Physical state of the digital input (without application of polarity, validity and time delays)

Variable	Physical status of digital input 6 [953.5]
Description	Physical state of the digital input (without application of polarity, validity and time delays)

Variable	Physical status of digital input 7 [953.6]
Description	Physical state of the digital input (without application of polarity, validity and time delays)

Variable	Physical status of digital input 8 [953.7]
Description	Physical state of the digital input (without application of polarity, validity and time delays)

OPERATOR MANUAL

Variable	Physical status of digital input 9 [953.8]
Description	Physical state of the digital input (without application of polarity, validity and time delays)

Variable	Output 1 (Customisable) [4350]
Description	Real time displayed status of Digital Output 1

Variable	Output 2 (Customisable) [4351]
Description	Real time displayed status of Digital Output 2

Variable	Output 3 (Customisable) [4352]
Description	Real time displayed status of Digital Output 3

Variable	Output 4 (Customisable) [4353]
Description	Real time displayed status of Digital Output 4

Variable	Output 5 (Customisable) [4354]
Description	Real time displayed status of Digital Output 5

Variable	Output 6 (Customisable) [4355]
Description	Real time displayed status of Digital Output 6

Variable	Relay 1 (Customisable) [4356]
Description	Real time displayed status of Relay Output 1

Variable	Relay 2 (Customisable) [4357]
Description	Real time displayed status of Relay Output 2

I/O CAN BUS EXPANSION

Variable	CANopen DI 1 (Customisable) [800]
Description	CANopen digital Input 1

Variable	CANopen DI 2 (Customisable) [801]
Description	CANopen digital Input 2

Variable	CANopen DI 3 (Customisable) [802]
Description	CANopen digital Input 3

Variable	CANopen DI 4 (Customisable) [803]
Description	CANopen digital Input 4

Variable	CANopen DI 5 (Customisable) [804]
Description	CANopen digital Input 5

Variable	CANopen DI 6 (Customisable) [805]
Description	CANopen digital Input 6

Variable	CANopen DI 7 (Customisable) [806]
Description	CANopen digital Input 7

Variable	CANopen DI 8 (Customisable) [807]
Description	CANopen digital Input 8

Variable	CANopen DI 9 (Customisable) [808]
Description	CANopen digital Input 9

Variable	CANopen DI 10 (Customisable) [809]
Description	CANopen digital Input 10

OPERATOR MANUAL

Variable	CANopen DI 11 (Customisable) [810]
Description	CANopen digital Input 11

Variable	CANopen DI 12 (Customisable) [811]
Description	CANopen digital Input 12

Variable	CANopen DI 13 (Customisable) [812]
Description	CANopen digital Input 13

Variable	CANopen DI 14 (Customisable) [813]
Description	CANopen digital Input 14

Variable	CANopen DI 15 (Customisable) [814]
Description	CANopen digital Input 15

Variable	CANopen DI 16 (Customisable) [815]
Description	CANopen digital Input 16

Variable	CANopen DI 17 (Customisable) [816]
Description	CANopen digital Input 17

Variable	CANopen DI 18 (Customisable) [817]
Description	CANopen digital Input 18

Variable	CANopen DI 19 (Customisable) [818]
Description	CANopen digital Input 19

Variable	CANopen DI 20 (Customisable) [819]
Description	CANopen digital Input 20

Variable	CANopen DI 21 (Customisable) [820]
Description	CANopen digital Input 21

OPERATOR MANUAL

Variable	CANopen DI 22 (Customisable) [821]
Description	CANopen digital Input 22

Variable	CANopen DI 23 (Customisable) [822]
Description	CANopen digital Input 23

Variable	CANopen DI 24 (Customisable) [823]
Description	CANopen digital Input 24

Variable	CANopen DI 25 (Customisable) [824]
Description	CANopen digital Input 25

Variable	CANopen DI 26 (Customisable) [825]
Description	CANopen digital Input 26

Variable	CANopen DI 27 (Customisable) [826]
Description	CANopen digital Input 27

Variable	CANopen DI 28 (Customisable) [827]
Description	CANopen digital Input 28

Variable	CANopen DI 29 (Customisable) [828]
Description	CANopen digital Input 29

Variable	CANopen DI 30 (Customisable) [829]
Description	CANopen digital Input 30

Variable	CANopen DI 31 (Customisable) [830]
Description	CANopen digital Input 31

Variable	CANopen DI 32 (Customisable) [831]
Description	CANopen digital Input 32

OPERATOR MANUAL

Variable	CANopen DI 33 (Customisable) [1250]
Description	CANopen digital Input 33

Variable	CANopen DI 34 (Customisable) [1251]
Description	CANopen digital Input 34

Variable	CANopen DI 35 (Customisable) [1252]
Description	CANopen digital Input 35

Variable	CANopen DI 36 (Customisable) [1253]
Description	CANopen digital Input 36

Variable	CANopen DI 37 (Customisable) [1254]
Description	CANopen digital Input 37

Variable	CANopen DI 38 (Customisable) [1255]
Description	CANopen digital Input 38

Variable	CANopen DI 39 (Customisable) [1256]
Description	CANopen digital Input 39

Variable	CANopen DI 40 (Customisable) [1257]
Description	CANopen digital Input 40

Variable	CANopen DI 41 (Customisable) [1258]
Description	CANopen digital Input 41

Variable	CANopen DI 42 (Customisable) [1259]
Description	CANopen digital Input 42

Variable	CANopen DI 43 (Customisable) [1260]
Description	CANopen digital Input 43

OPERATOR MANUAL

Variable	CANopen DI 44 (Customisable) [1261]
Description	CANopen digital Input 44

Variable	CANopen DI 45 (Customisable) [1262]
Description	CANopen digital Input 45

Variable	CANopen DI 46 (Customisable) [1263]
Description	CANopen digital Input 46

Variable	CANopen DI 47 (Customisable) [1264]
Description	CANopen digital Input 47

Variable	CANopen DI 48 (Customisable) [1265]
Description	CANopen digital Input 48

Variable	CANopen DI 49 (Customisable) [1266]
Description	CANopen digital Input 49

Variable	CANopen DI 50 (Customisable) [1267]
Description	CANopen digital Input 50

Variable	CANopen DI 51 (Customisable) [1268]
Description	CANopen digital Input 51

Variable	CANopen DI 52 (Customisable) [1269]
Description	CANopen digital Input 52

Variable	CANopen DI 53 (Customisable) [1270]
Description	CANopen digital Input 53

Variable	CANopen DI 54 (Customisable) [1271]
Description	CANopen digital Input 54

OPERATOR MANUAL

Variable	CANopen DI 55 (Customisable) [1272]
Description	CANopen digital Input 55

Variable	CANopen DI 56 (Customisable) [1273]
Description	CANopen digital Input 56

Variable	CANopen DI 57 (Customisable) [1274]
Description	CANopen digital Input 57

Variable	CANopen DI 58 (Customisable) [1275]
Description	CANopen digital Input 58

Variable	CANopen DI 59 (Customisable) [1276]
Description	CANopen digital Input 59

Variable	CANopen DI 60 (Customisable) [1277]
Description	CANopen digital Input 60

Variable	CANopen DI 61 (Customisable) [1278]
Description	CANopen digital Input 61

Variable	CANopen DI 62 (Customisable) [1279]
Description	CANopen digital Input 62

Variable	CANopen DI 63 (Customisable) [1280]
Description	CANopen digital Input 63

Variable	CANopen DI 64 (Customisable) [1281]
Description	CANopen digital Input 64

Variable	CANopen DO 1 (Customisable) [4751]
Description	CANopen digital output 1

OPERATOR MANUAL

Variable	CANopen DO 2 (Customisable) [4752]
Description	CANopen digital output 2

Variable	CANopen DO 3 (Customisable) [4753]
Description	CANopen digital output 3

Variable	CANopen DO 4 (Customisable) [4754]
Description	CANopen digital output 4

Variable	CANopen DO 5 (Customisable) [4755]
Description	CANopen digital output 5

Variable	CANopen DO 6 (Customisable) [4756]
Description	CANopen digital output 6

Variable	CANopen DO 7 (Customisable) [4757]
Description	CANopen digital output 7

Variable	CANopen DO 8 (Customisable) [4758]
Description	CANopen digital output 8

Variable	CANopen DO 9 (Customisable) [4759]
Description	CANopen digital output 9

Variable	CANopen DO 10 (Customisable) [4760]
Description	CANopen digital output 10

Variable	CANopen DO 11 (Customisable) [4761]
Description	CANopen digital output 11

Variable	CANopen DO 12 (Customisable) [4762]
Description	CANopen digital output 12

OPERATOR MANUAL

Variable	CANopen DO 13 (Customisable) [4763]
Description	CANopen digital output 13

Variable	CANopen DO 14 (Customisable) [4764]
Description	CANopen digital output 14

Variable	CANopen DO 15 (Customisable) [4765]
Description	CANopen digital output 15

Variable	CANopen DO 16 (Customisable) [4766]
Description	CANopen digital output 16

Variable	CANopen DO 17 (Customisable) [4767]
Description	CANopen digital output 17

Variable	CANopen DO 18 (Customisable) [4768]
Description	CANopen digital output 18

Variable	CANopen DO 19 (Customisable) [4769]
Description	CANopen digital output 19

Variable	CANopen DO 20 (Customisable) [4770]
Description	CANopen digital output 20

Variable	CANopen DO 21 (Customisable) [4771]
Description	CANopen digital output 21

Variable	CANopen DO 22 (Customisable) [4772]
Description	CANopen digital output 22

Variable	CANopen DO 23 (Customisable) [4773]
Description	CANopen digital output 23

OPERATOR MANUAL

Variable	CANopen DO 24 (Customisable) [4774]
Description	CANopen digital output 24

Variable	CANopen DO 25 (Customisable) [4775]
Description	CANopen digital output 25

Variable	CANopen DO 26 (Customisable) [4776]
Description	CANopen digital output 26

Variable	CANopen DO 27 (Customisable) [4777]
Description	CANopen digital output 27

Variable	CANopen DO 28 (Customisable) [4778]
Description	CANopen digital output 28

Variable	CANopen DO 29 (Customisable) [4779]
Description	CANopen digital output 29

Variable	CANopen DO 30 (Customisable) [4780]
Description	CANopen digital output 30

Variable	CANopen DO 31 (Customisable) [4781]
Description	CANopen digital output 31

Variable	CANopen DO 32 (Customisable) [4782]
Description	CANopen digital output 32

Variable	CANopen DO 33 (Customisable) [5100]
Description	CANopen digital output 33

Variable	CANopen DO 34 (Customisable) [5101]
Description	CANopen digital output 34

OPERATOR MANUAL

Variable	CANopen DO 35 (Customisable) [5102]
Description	CANopen digital output 35

Variable	CANopen DO 36 (Customisable) [5103]
Description	CANopen digital output 36

Variable	CANopen DO 37 (Customisable) [5104]
Description	CANopen digital output 37

Variable	CANopen DO 38 (Customisable) [5105]
Description	CANopen digital output 38

Variable	CANopen DO 39 (Customisable) [5106]
Description	CANopen digital output 39

Variable	CANopen DO 40 (Customisable) [5107]
Description	CANopen digital output 40

Variable	CANopen DO 41 (Customisable) [5108]
Description	CANopen digital output 41

Variable	CANopen DO 42 (Customisable) [5109]
Description	CANopen digital output 42

Variable	CANopen DO 43 (Customisable) [5110]
Description	CANopen digital output 43

Variable	CANopen DO 44 (Customisable) [5111]
Description	CANopen digital output 44

Variable	CANopen DO 45 (Customisable) [5112]
Description	CANopen digital output 45

OPERATOR MANUAL

Variable	CANopen DO 46 (Customisable) [5113]
Description	CANopen digital output 46

Variable	CANopen DO 47 (Customisable) [5114]
Description	CANopen digital output 47

Variable	CANopen DO 48 (Customisable) [5115]
Description	CANopen digital output 48

Variable	CANopen DO 49 (Customisable) [5116]
Description	CANopen digital output 49

Variable	CANopen DO 50 (Customisable) [5117]
Description	CANopen digital output 50

Variable	CANopen DO 51 (Customisable) [5118]
Description	CANopen digital output 51

Variable	CANopen DO 52 (Customisable) [5119]
Description	CANopen digital output 52

Variable	CANopen DO 53 (Customisable) [5120]
Description	CANopen digital output 53

Variable	CANopen DO 54 (Customisable) [5121]
Description	CANopen digital output 54

Variable	CANopen DO 55 (Customisable) [5122]
Description	CANopen digital output 55

Variable	CANopen DO 56 (Customisable) [5123]
Description	CANopen digital output 56

OPERATOR MANUAL

Variable	CANopen DO 57 (Customisable) [5124]
Description	CANopen digital output 57

Variable	CANopen DO 58 (Customisable) [5125]
Description	CANopen digital output 58

Variable	CANopen DO 59 (Customisable) [5126]
Description	CANopen digital output 59

Variable	CANopen DO 60 (Customisable) [5127]
Description	CANopen digital output 60

Variable	CANopen DO 61 (Customisable) [5128]
Description	CANopen digital output 61

Variable	CANopen DO 62 (Customisable) [5129]
Description	CANopen digital output 62

Variable	CANopen DO 63 (Customisable) [5130]
Description	CANopen digital output 63

Variable	CANopen DO 64 (Customisable) [5131]
Description	CANopen digital output 64

POWER PLANT

Variable	Generator No.1 circuit breaker position [562.0]
Description	0 if circuit breaker opened, 1 if circuit breaker closed

Variable	Generator No.2 circuit breaker position [562.1]
Description	0 if circuit breaker opened, 1 if circuit breaker closed

Variable	Generator No.3 circuit breaker position [562.2]
Description	0 if circuit breaker opened, 1 if circuit breaker closed

Variable	Generator No.4 circuit breaker position [562.3]
Description	0 if circuit breaker opened, 1 if circuit breaker closed

Variable	Generator No.5 circuit breaker position [562.4]
Description	0 if circuit breaker opened, 1 if circuit breaker closed

Variable	Generator No.6 circuit breaker position [562.5]
Description	0 if circuit breaker opened, 1 if circuit breaker closed

Variable	Generator No.7 circuit breaker position [562.6]
Description	0 if circuit breaker opened, 1 if circuit breaker closed

Variable	Generator No.8 circuit breaker position [562.7]
Description	0 if circuit breaker opened, 1 if circuit breaker closed

Variable	Generator No.9 circuit breaker position [562.8]
Description	0 if circuit breaker opened, 1 if circuit breaker closed

Variable	Generator No.10 circuit breaker position [562.9]
Description	0 if circuit breaker opened, 1 if circuit breaker closed

OPERATOR MANUAL

Variable	Generator No.11 circuit breaker position [562.10]
Description	0 if circuit breaker opened, 1 if circuit breaker closed

Variable	Generator No.12 circuit breaker position [562.11]
Description	0 if circuit breaker opened, 1 if circuit breaker closed

Variable	Generator No.13 circuit breaker position [562.12]
Description	0 if circuit breaker opened, 1 if circuit breaker closed

Variable	Generator No.14 circuit breaker position [562.13]
Description	0 if circuit breaker opened, 1 if circuit breaker closed

Variable	Generator No.15 circuit breaker position [562.14]
Description	0 if circuit breaker opened, 1 if circuit breaker closed

Variable	Generator No.16 circuit breaker position [562.15]
Description	0 if circuit breaker opened, 1 if circuit breaker closed

Variable	Generator No.17 circuit breaker position [563.0]
Description	0 if circuit breaker opened, 1 if circuit breaker closed

Variable	Generator No.18 circuit breaker position [563.1]
Description	0 if circuit breaker opened, 1 if circuit breaker closed

Variable	Generator No.19 circuit breaker position [563.2]
Description	0 if circuit breaker opened, 1 if circuit breaker closed

Variable	Generator No.20 circuit breaker position [563.3]
Description	0 if circuit breaker opened, 1 if circuit breaker closed

Variable	Generator No.21 circuit breaker position [563.4]
Description	0 if circuit breaker opened, 1 if circuit breaker closed

OPERATOR MANUAL

Variable	Generator No.22 circuit breaker position [563.5]
Description	0 if circuit breaker opened, 1 if circuit breaker closed

Variable	Generator No.23 circuit breaker position [563.6]
Description	0 if circuit breaker opened, 1 if circuit breaker closed

Variable	Generator No.24 circuit breaker position [563.7]
Description	0 if circuit breaker opened, 1 if circuit breaker closed

Variable	Generator No.25 circuit breaker position [563.8]
Description	0 if circuit breaker opened, 1 if circuit breaker closed

Variable	Generator No.26 circuit breaker position [563.9]
Description	0 if circuit breaker opened, 1 if circuit breaker closed

Variable	Generator No.27 circuit breaker position [563.10]
Description	0 if circuit breaker opened, 1 if circuit breaker closed

Variable	Generator No.28 circuit breaker position [563.11]
Description	0 if circuit breaker opened, 1 if circuit breaker closed

Variable	Generator No.29 circuit breaker position [563.12]
Description	0 if circuit breaker opened, 1 if circuit breaker closed

Variable	Generator No.30 circuit breaker position [563.13]
Description	0 if circuit breaker opened, 1 if circuit breaker closed

Variable	Generator No.31 circuit breaker position [563.14]
Description	0 if circuit breaker opened, 1 if circuit breaker closed

Variable	Generator No.32 circuit breaker position [563.15]
Description	0 if circuit breaker opened, 1 if circuit breaker closed

OPERATOR MANUAL

Variable	Mains/tie breaker No.1 circuit breaker position [976.0]
Description	On MASTER COMPACT 1B, 0 if circuit breaker opened, 1 if circuit breaker closed. On MASTER COMPACT, 0 if at least 1 of the 2 circuit breakers is opened, 1 if both circuit breakers are closed. On BTB COMPACT, 0 if circuit breaker opened, 1 if circuit breaker closed.

Variable	Mains/tie breaker No.2 circuit breaker position [976.1]
Description	On MASTER COMPACT 1B, 0 if circuit breaker opened, 1 if circuit breaker closed. On MASTER COMPACT, 0 if at least 1 of the 2 circuit breakers is opened, 1 if both circuit breakers are closed. On BTB COMPACT, 0 if circuit breaker opened, 1 if circuit breaker closed.

Variable	Mains/tie breaker No.3 circuit breaker position [976.2]
Description	On MASTER COMPACT 1B, 0 if circuit breaker opened, 1 if circuit breaker closed. On MASTER COMPACT, 0 if at least 1 of the 2 circuit breakers is opened, 1 if both circuit breakers are closed. On BTB COMPACT, 0 if circuit breaker opened, 1 if circuit breaker closed.

Variable	Mains/tie breaker No.4 circuit breaker position [976.3]
Description	On MASTER COMPACT 1B, 0 if circuit breaker opened, 1 if circuit breaker closed. On MASTER COMPACT, 0 if at least 1 of the 2 circuit breakers is opened, 1 if both circuit breakers are closed. On BTB COMPACT, 0 if circuit breaker opened, 1 if circuit breaker closed.

Variable	Mains/tie breaker No.5 circuit breaker position [976.4]
Description	On MASTER COMPACT 1B, 0 if circuit breaker opened, 1 if circuit breaker closed. On MASTER COMPACT, 0 if at least 1 of the 2 circuit breakers is opened, 1 if both circuit breakers are closed. On BTB COMPACT, 0 if circuit breaker opened, 1 if circuit breaker closed.

Variable	Mains/tie breaker No.6 circuit breaker position [976.5]
Description	On MASTER COMPACT 1B, 0 if circuit breaker opened, 1 if circuit breaker closed. On MASTER COMPACT, 0 if at least 1 of the 2 circuit breakers is opened, 1 if both circuit breakers are closed. On BTB COMPACT, 0 if circuit breaker opened, 1 if circuit breaker closed.

Variable	Mains/tie breaker No.7 circuit breaker position [976.6]
Description	On MASTER COMPACT 1B, 0 if circuit breaker opened, 1 if circuit breaker closed. On MASTER COMPACT, 0 if at least 1 of the 2 circuit breakers is opened, 1 if both circuit breakers are closed. On BTB COMPACT, 0 if circuit breaker opened, 1 if circuit breaker closed.

OPERATOR MANUAL

Variable	Mains/tie breaker No.8 circuit breaker position [976.7]
Description	On MASTER COMPACT 1B, 0 if circuit breaker opened, 1 if circuit breaker closed. On MASTER COMPACT, 0 if at least 1 of the 2 circuit breakers is opened, 1 if both circuit breakers are closed. On BTB COMPACT, 0 if circuit breaker opened, 1 if circuit breaker closed.

Variable	Mains/tie breaker No.9 circuit breaker position [976.8]
Description	On MASTER COMPACT 1B, 0 if circuit breaker opened, 1 if circuit breaker closed. On MASTER COMPACT, 0 if at least 1 of the 2 circuit breakers is opened, 1 if both circuit breakers are closed. On BTB COMPACT, 0 if circuit breaker opened, 1 if circuit breaker closed.

Variable	Mains/tie breaker No.10 circuit breaker position [976.9]
Description	On MASTER COMPACT 1B, 0 if circuit breaker opened, 1 if circuit breaker closed. On MASTER COMPACT, 0 if at least 1 of the 2 circuit breakers is opened, 1 if both circuit breakers are closed. On BTB COMPACT, 0 if circuit breaker opened, 1 if circuit breaker closed.

Variable	Mains/tie breaker No.11 circuit breaker position [976.10]
Description	On MASTER COMPACT 1B, 0 if circuit breaker opened, 1 if circuit breaker closed. On MASTER COMPACT, 0 if at least 1 of the 2 circuit breakers is opened, 1 if both circuit breakers are closed. On BTB COMPACT, 0 if circuit breaker opened, 1 if circuit breaker closed.

Variable	Mains/tie breaker No.12 circuit breaker position [976.11]
Description	On MASTER COMPACT 1B, 0 if circuit breaker opened, 1 if circuit breaker closed. On MASTER COMPACT, 0 if at least 1 of the 2 circuit breakers is opened, 1 if both circuit breakers are closed. On BTB COMPACT, 0 if circuit breaker opened, 1 if circuit breaker closed.

Variable	Mains/tie breaker No.13 circuit breaker position [976.12]
Description	On MASTER COMPACT 1B, 0 if circuit breaker opened, 1 if circuit breaker closed. On MASTER COMPACT, 0 if at least 1 of the 2 circuit breakers is opened, 1 if both circuit breakers are closed. On BTB COMPACT, 0 if circuit breaker opened, 1 if circuit breaker closed.

Variable	Mains/tie breaker No.14 circuit breaker position [976.13]
Description	On MASTER COMPACT 1B, 0 if circuit breaker opened, 1 if circuit breaker closed. On MASTER COMPACT, 0 if at least 1 of the 2 circuit breakers is opened, 1 if both circuit breakers are closed. On BTB COMPACT, 0 if circuit breaker opened, 1 if circuit breaker closed.

OPERATOR MANUAL

Variable	Mains/tie breaker No.15 circuit breaker position [976.14]
Description	On MASTER COMPACT 1B, 0 if circuit breaker opened, 1 if circuit breaker closed. On MASTER COMPACT, 0 if at least 1 of the 2 circuit breakers is opened, 1 if both circuit breakers are closed. On BTB COMPACT, 0 if circuit breaker opened, 1 if circuit breaker closed.

Variable	Mains/tie breaker No.16 circuit breaker position [976.15]
Description	On MASTER COMPACT 1B, 0 if circuit breaker opened, 1 if circuit breaker closed. On MASTER COMPACT, 0 if at least 1 of the 2 circuit breakers is opened, 1 if both circuit breakers are closed. On BTB COMPACT, 0 if circuit breaker opened, 1 if circuit breaker closed.

Variable	Mains/tie breaker No.17 circuit breaker position [977.0]
Description	On MASTER COMPACT 1B, 0 if circuit breaker opened, 1 if circuit breaker closed. On MASTER COMPACT, 0 if at least 1 of the 2 circuit breakers is opened, 1 if both circuit breakers are closed. On BTB COMPACT, 0 if circuit breaker opened, 1 if circuit breaker closed.

Variable	Mains/tie breaker No.18 circuit breaker position [977.1]
Description	On MASTER COMPACT 1B, 0 if circuit breaker opened, 1 if circuit breaker closed. On MASTER COMPACT, 0 if at least 1 of the 2 circuit breakers is opened, 1 if both circuit breakers are closed. On BTB COMPACT, 0 if circuit breaker opened, 1 if circuit breaker closed.

Variable	Mains/tie breaker No.19 circuit breaker position [977.2]
Description	On MASTER COMPACT 1B, 0 if circuit breaker opened, 1 if circuit breaker closed. On MASTER COMPACT, 0 if at least 1 of the 2 circuit breakers is opened, 1 if both circuit breakers are closed. On BTB COMPACT, 0 if circuit breaker opened, 1 if circuit breaker closed.

Variable	Mains/tie breaker No.20 circuit breaker position [977.3]
Description	On MASTER COMPACT 1B, 0 if circuit breaker opened, 1 if circuit breaker closed. On MASTER COMPACT, 0 if at least 1 of the 2 circuit breakers is opened, 1 if both circuit breakers are closed. On BTB COMPACT, 0 if circuit breaker opened, 1 if circuit breaker closed.

Variable	Mains/tie breaker No.21 circuit breaker position [977.4]
Description	On MASTER COMPACT 1B, 0 if circuit breaker opened, 1 if circuit breaker closed. On MASTER COMPACT, 0 if at least 1 of the 2 circuit breakers is opened, 1 if both circuit breakers are closed. On BTB COMPACT, 0 if circuit breaker opened, 1 if circuit breaker closed.

OPERATOR MANUAL

Variable	Mains/tie breaker No.22 circuit breaker position [977.5]
Description	On MASTER COMPACT 1B, 0 if circuit breaker opened, 1 if circuit breaker closed. On MASTER COMPACT, 0 if at least 1 of the 2 circuit breakers is opened, 1 if both circuit breakers are closed. On BTB COMPACT, 0 if circuit breaker opened, 1 if circuit breaker closed.

Variable	Mains/tie breaker No.23 circuit breaker position [977.6]
Description	On MASTER COMPACT 1B, 0 if circuit breaker opened, 1 if circuit breaker closed. On MASTER COMPACT, 0 if at least 1 of the 2 circuit breakers is opened, 1 if both circuit breakers are closed. On BTB COMPACT, 0 if circuit breaker opened, 1 if circuit breaker closed.

Variable	Mains/tie breaker No.24 circuit breaker position [977.7]
Description	On MASTER COMPACT 1B, 0 if circuit breaker opened, 1 if circuit breaker closed. On MASTER COMPACT, 0 if at least 1 of the 2 circuit breakers is opened, 1 if both circuit breakers are closed. On BTB COMPACT, 0 if circuit breaker opened, 1 if circuit breaker closed.

Variable	Mains/tie breaker No.25 circuit breaker position [977.8]
Description	On MASTER COMPACT 1B, 0 if circuit breaker opened, 1 if circuit breaker closed. On MASTER COMPACT, 0 if at least 1 of the 2 circuit breakers is opened, 1 if both circuit breakers are closed. On BTB COMPACT, 0 if circuit breaker opened, 1 if circuit breaker closed.

Variable	Mains/tie breaker No.26 circuit breaker position [977.9]
Description	On MASTER COMPACT 1B, 0 if circuit breaker opened, 1 if circuit breaker closed. On MASTER COMPACT, 0 if at least 1 of the 2 circuit breakers is opened, 1 if both circuit breakers are closed. On BTB COMPACT, 0 if circuit breaker opened, 1 if circuit breaker closed.

Variable	Mains/tie breaker No.27 circuit breaker position [977.10]
Description	On MASTER COMPACT 1B, 0 if circuit breaker opened, 1 if circuit breaker closed. On MASTER COMPACT, 0 if at least 1 of the 2 circuit breakers is opened, 1 if both circuit breakers are closed. On BTB COMPACT, 0 if circuit breaker opened, 1 if circuit breaker closed.

Variable	Mains/tie breaker No.28 circuit breaker position [977.11]
Description	On MASTER COMPACT 1B, 0 if circuit breaker opened, 1 if circuit breaker closed. On MASTER COMPACT, 0 if at least 1 of the 2 circuit breakers is opened, 1 if both circuit breakers are closed. On BTB COMPACT, 0 if circuit breaker opened, 1 if circuit breaker closed.

OPERATOR MANUAL

Variable	Mains/tie breaker No.29 circuit breaker position [977.12]
Description	On MASTER COMPACT 1B, 0 if circuit breaker opened, 1 if circuit breaker closed. On MASTER COMPACT, 0 if at least 1 of the 2 circuit breakers is opened, 1 if both circuit breakers are closed. On BTB COMPACT, 0 if circuit breaker opened, 1 if circuit breaker closed.

Variable	Mains/tie breaker No.30 circuit breaker position [977.13]
Description	On MASTER COMPACT 1B, 0 if circuit breaker opened, 1 if circuit breaker closed. On MASTER COMPACT, 0 if at least 1 of the 2 circuit breakers is opened, 1 if both circuit breakers are closed. On BTB COMPACT, 0 if circuit breaker opened, 1 if circuit breaker closed.

Variable	Mains/tie breaker No.31 circuit breaker position [977.14]
Description	On MASTER COMPACT 1B, 0 if circuit breaker opened, 1 if circuit breaker closed. On MASTER COMPACT, 0 if at least 1 of the 2 circuit breakers is opened, 1 if both circuit breakers are closed. On BTB COMPACT, 0 if circuit breaker opened, 1 if circuit breaker closed.

Variable	Mains/tie breaker No.32 circuit breaker position [977.15]
Description	On MASTER COMPACT 1B, 0 if circuit breaker opened, 1 if circuit breaker closed. On MASTER COMPACT, 0 if at least 1 of the 2 circuit breakers is opened, 1 if both circuit breakers are closed. On BTB COMPACT, 0 if circuit breaker opened, 1 if circuit breaker closed.

Variable	Mains presence on the common bus bar [4032]
Description	Status report: There is currently a mains closed on the bus bar

BUS PROTECTIONS

Variable	Fail to synchronize [4051]
Description	The automated system does not manage to synchronize the voltages on both sides of the circuit breaker (Check that the speed regulation and the AVR are controlled in the right range and adjust the PID settings)

Variable	Mismatch rotophases level 1 [4053.0]
Description	Active when the level 1 protection triggered.

Variable	Mismatch rotophases level 2 [4053.1]
Description	Active when the level 2 protection triggered.

Variable	Bus over frequency level 1 [4250.0]
Description	Active when the level 1 protection triggered.

Variable	Bus over frequency level 2 [4250.1]
Description	Active when the level 2 protection triggered.

Variable	Bus under frequency level 1 [4251.0]
Description	Active when the level 1 protection triggered.

Variable	Bus under frequency level 2 [4251.1]
Description	Active when the level 2 protection triggered.

Variable	Bus over voltage level 1 [4252.0]
Description	Active when the level 1 protection triggered.

Variable	Bus over voltage level 2 [4252.1]
Description	Active when the level 2 protection triggered.

Variable	Bus under voltage level 1 [4253.0]
Description	Active when the level 1 protection triggered.

OPERATOR MANUAL

Variable	Bus under voltage level 2 [4253.1]
Description	Active when the level 2 protection triggered.

Variable	Bus minimum KW level 1 [4254.0]
Description	Active when the level 1 protection triggered.

Variable	Bus minimum KW level 2 [4254.1]
Description	Active when the level 2 protection triggered.

Variable	Bus maximum KW level 1 [4255.0]
Description	Active when the level 1 protection triggered.

Variable	Bus maximum KW level 2 [4255.1]
Description	Active when the level 2 protection triggered.

Variable	Bus reverse KW level 1 [4256.0]
Description	Active when the level 1 protection triggered.

Variable	Bus reverse KW level 2 [4256.1]
Description	Active when the level 2 protection triggered.

Variable	Bus minimum KVAR level 1 [4257.0]
Description	Active when the level 1 protection triggered.

Variable	Bus minimum KVAR level 2 [4257.1]
Description	Active when the level 2 protection triggered.

Variable	Bus maximum KVAR level 1 [4258.0]
Description	Active when the level 1 protection triggered.

Variable	Bus maximum KVAR level 2 [4258.1]
Description	Active when the level 2 protection triggered.

OPERATOR MANUAL

Variable	Bus reverse KVAR level 1 [4259.0]
Description	Active when the level 1 protection triggered.

Variable	Bus reverse KVAR level 2 [4259.1]
Description	Active when the level 2 protection triggered.

Variable	Bus maximum current level 1 [4260.0]
Description	Active when the level 1 protection triggered.

Variable	Bus maximum current level 2 [4260.1]
Description	Active when the level 2 protection triggered.

Variable	Bus short-circuit level 1 [4262.0]
Description	Active when the level 1 protection triggered.

Variable	Bus short-circuit level 2 [4262.1]
Description	Active when the level 2 protection triggered.

Variable	Bus voltage unbalance level 1 [4268.0]
Description	Active when the level 1 protection triggered.

Variable	Bus voltage unbalance level 2 [4268.1]
Description	Active when the level 2 protection triggered.

Variable	Not enough genset available level 1 [4270.0]
Description	Active when the level 1 protection triggered.

Variable	Not enough genset available level 2 [4270.1]
Description	Active when the level 2 protection triggered.

Variable	No genset available [4271]
Description	No genset available

OPERATOR MANUAL

Variable	Bus rotophase level 1 [4272.0]
Description	Active when the level 1 protection triggered.

Variable	Bus rotophase level 2 [4272.1]
Description	Active when the level 2 protection triggered.

MAINS PROTECTIONS

Variable	Mains over frequency level 1 [4300.0]
Description	Active when the level 1 protection triggered.

Variable	Mains over frequency level 2 [4300.1]
Description	Active when the level 2 protection triggered.

Variable	Mains under frequency level 1 [4301.0]
Description	Active when the level 1 protection triggered.

Variable	Mains under frequency level 2 [4301.1]
Description	Active when the level 2 protection triggered.

Variable	Mains over voltage level 1 [4302.0]
Description	Active when the level 1 protection triggered.

Variable	Mains over voltage level 2 [4302.1]
Description	Active when the level 2 protection triggered.

Variable	Mains under voltage level 1 [4303.0]
Description	Active when the level 1 protection triggered.

Variable	Mains under voltage level 2 [4303.1]
Description	Active when the level 2 protection triggered.

Variable	Mains minimum KW level 1 [4304.0]
Description	Active when the level 1 protection triggered.

Variable	Mains minimum KW level 2 [4304.1]
Description	Active when the level 2 protection triggered.

OPERATOR MANUAL

Variable	Mains maximum KW level 1 [4305.0]
Description	Active when the level 1 protection triggered.

Variable	Mains maximum KW level 2 [4305.1]
Description	Active when the level 2 protection triggered.

Variable	Mains reverse KW level 1 [4306.0]
Description	Active when the level 1 protection triggered.

Variable	Mains reverse KW level 2 [4306.1]
Description	Active when the level 2 protection triggered.

Variable	Mains minimum KVAR level 1 [4307.0]
Description	Active when the level 1 protection triggered.

Variable	Mains minimum KVAR level 2 [4307.1]
Description	Active when the level 2 protection triggered.

Variable	Mains maximum KVAR level 1 [4308.0]
Description	Active when the level 1 protection triggered.

Variable	Mains maximum KVAR level 2 [4308.1]
Description	Active when the level 2 protection triggered.

Variable	Mains reverse KVAR level 1 [4309.0]
Description	Active when the level 1 protection triggered.

Variable	Mains reverse KVAR level 2 [4309.1]
Description	Active when the level 2 protection triggered.

Variable	Vector jump level 1 [4310.0]
Description	Active when the level 1 protection triggered.

OPERATOR MANUAL

Variable	Vector jump level 2 [4310.1]
Description	Active when the level 2 protection triggered.

Variable	df/dt level 1 [4311.0]
Description	Active when the level 1 protection triggered.

Variable	df/dt level 2 [4311.1]
Description	Active when the level 2 protection triggered.

Variable	Mains voltage unbalance level 1 [4314.0]
Description	Active when the level 1 protection triggered.

Variable	Mains voltage unbalance level 2 [4314.1]
Description	Active when the level 2 protection triggered.

Variable	Bus current unbalance level 1 [4316.0]
Description	Active when the level 1 protection triggered.

Variable	Bus current unbalance level 2 [4316.1]
Description	Active when the level 2 protection triggered.

Variable	Mains rotophase level 1 [4318.0]
Description	Active when the level 1 protection triggered.

Variable	Mains rotophase level 2 [4318.1]
Description	Active when the level 2 protection triggered.

OTHER PROTECTIONS

Variable	Battery minimum voltage level 1 [4202.0]
Description	Active when the level 1 protection triggered.

Variable	Battery minimum voltage level 2 [4202.1]
Description	Active when the level 2 protection triggered.

Variable	Battery maximum voltage level 1 [4203.0]
Description	Active when the level 1 protection triggered.

Variable	Battery maximum voltage level 2 [4203.1]
Description	Active when the level 2 protection triggered.

COMMUNICATION

Variable	Controller communication fault [600]
Description	Communication cannot be established. Check the wiring between the controllers, the product number and the number of controllers declared for each part number.

Variable	Missing GENSYS COMPACT PRIME [605]
Description	Missing at least one GENSYS COMPACT PRIME module on the CAN bus

Variable	Missing MASTER COMPACT or BTB COMPACT [608]
Description	Absence of at least one MASTER COMPACT or BTB COMPACT module on the CAN bus

Variable	Missing HYBRID COMPACT [612]
Description	Missing at least one HYBRID module on the CAN bus

Variable	Missing BAT COMPACT [613]
Description	Missing at least one BAT COMPACT module on the CAN Bus

Variable	Modbus server (Customisable) [904]
Description	Modbus server connection timeout. The associated label can be changed for display when the error occurs.

Variable	CANopen fault [4750]
Description	Communication with I/O extension cannot be established. Check the wiring and power supply of the CANopen extension module

STATUSES

Variable	Phase sequence match [306]
Description	Identical phase order on both sides of the circuit breaker (OK = 1 or NOK = 0)

Variable	Voltage match [307]
Description	Identical voltage amplitudes on both sides of the circuit breaker (OK = 1 or NOK = 0)

Variable	Frequency match [308]
Description	Identical frequencies on both sides of the circuit breaker (OK = 1 or NOK = 0)

Variable	Phase match [309]
Description	The phase difference between the voltages on either side of the circuit breaker is zero (OK = 1 or NOK = 0)

Variable	Synch check relay OK [310]
Description	Active if the sources are synchronized on both sides of circuit breaker (OK = 1 or Not OK = 0). Do not confuse with the closing order.

Variable	Production request [4007]
Description	Active if the automated system wants to produce power with the generator(s). Inactive if the automated system does not want to produce power with the generator(s).

Variable	Bus electrical fault summary [4656]
Description	Fault report: Active if at least one protection configured as a bus electrical fault is active.

Variable	Mains electrical fault summary [4657]
Description	Fault report: Active if at least one protection configured as a mains electrical fault is active.

Variable	Alarms summary [4658]
Description	Fault report: Active if at least one protection configured as an alarm is active.

OPERATOR MANUAL

Variable	Soft shut down summary [4659]
Description	Fault report: Active if at least one protection configured as Soft shut down is active.

Variable	Default LED [4664]
Description	Status report: Active if the fault LED on the front of the product is lit (active on fault, reset on acknowledge and reset command).

Variable	Alarm LED [4665]
Description	Status report: Active if the alarm LED on the front of the product is lit (active on alarm, reset on acknowledge and reset command).

Variable	Auto mode LED [4666]
Description	Status report: Active if the Auto mode LED on the front of the product is lit

Variable	Test mode LED [4667]
Description	Status report: Active if the Test mode LED on the front of the product is lit

Variable	Manu mode LED [4668]
Description	Status report: Active if the Manu mode LED on the front of the product is lit

Variable	Bus LED [4669]
Description	Status report: Active if the Bus LED on the front of the product is lit

Variable	Protection validation [4681]
Description	Status report: Active when all protections are activated after starting sequence (Under frequency, under voltage, oil pressure, temperature, etc...)

Variable	Mains failure summary [4731]
Description	Active if at least one protection configured as Mains failure is activate.

Variable	Bus breaker LED [4734]
Description	Status report: Active if the Bus breaker LED on the front of the product is lit

OPERATOR MANUAL

Variable	Mains breaker LED [4735]
Description	Status report: Active if the Mains breaker LED on the front of the product is lit

Variable	Mains LED [4736]
Description	Status report: Active if the Mains LED on the front of the product is lit (voltage presence on Mains)

HYSTERESIS

Variable	Hysteresis 1 output [4710]
Description	Activation of analog Hysteresis function n°1, configuration of function is in Configuration/programming/Hysteresis

Variable	Hysteresis 2 output [4711]
Description	Activation of analog Hysteresis function n°2, configuration of function is in Configuration/programming/Hysteresis

Variable	Hysteresis 3 output [4712]
Description	Activation of analog Hysteresis function n°3, configuration of function is in Configuration/programming/Hysteresis

Variable	Hysteresis output activation on DI1 [4713]
Description	Output activation for 'Hysteresis on digital input' n°1. Function is managed by configurable low/high digital inputs in Digital Input menu.

Variable	Hysteresis output activation on DI2 [4714]
Description	Output activation for 'Hysteresis on digital input' n°2. Function is managed by configurable low/high digital inputs in Digital Input menu.

Variable	Hysteresis output activation on DI3 [4715]
Description	Output activation for 'Hysteresis on digital input' n°3. Function is managed by configurable low/high digital inputs in Digital Input menu.

Variable	Hysteresis output activation on DI4 [4716]
Description	Output activation for 'Hysteresis on digital input' n°4. Function is managed by configurable low/high digital inputs in Digital Input menu.

Variable	Hysteresis output activation on DI5 [4717]
Description	Output activation for 'Hysteresis on digital input' n°5. Function is managed by configurable low/high digital inputs in Digital Input menu.

Variable	Hysteresis output activation on DI6 [4718]
Description	Output activation for 'Hysteresis on digital input' n°6. Function is managed by configurable low/high digital inputs in Digital Input menu.

OPERATOR MANUAL

Variable	Hysteresis output activation on DI7 [4719]
Description	Output activation for 'Hysteresis on digital input' n°7. Function is managed by configurable low/high digital inputs in Digital Input menu.

Variable	Hysteresis output activation on DI8 [4720]
Description	Output activation for 'Hysteresis on digital input' n°8. Function is managed by configurable low/high digital inputs in Digital Input menu.

REMOTE BUTTONS

Variable	Shift button [951.0]
Description	Active (1) if the button is pressed. Inactive (0) otherwise.

Variable	Right arrow button [951.1]
Description	Active (1) if the button is pressed. Inactive (0) otherwise.

Variable	Down arrow button [951.2]
Description	Active (1) if the button is pressed. Inactive (0) otherwise.

Variable	Left arrow button [951.3]
Description	Active (1) if the button is pressed. Inactive (0) otherwise.

Variable	Up arrow button [951.4]
Description	Active (1) if the button is pressed. Inactive (0) otherwise.

Variable	Enter button [951.5]
Description	Active (1) if the button is pressed. Inactive (0) otherwise.

Variable	Esc button [951.6]
Description	Active (1) if the button is pressed. Inactive (0) otherwise.

Variable	Fault/Alarm/info button [951.7]
Description	Active (1) if the button is pressed. Inactive (0) otherwise.

Variable	Mains breaker button [951.8]
Description	Active (1) if the button is pressed. Inactive (0) otherwise.

Variable	Bus breaker button [951.9]
Description	Active (1) if the button is pressed. Inactive (0) otherwise.

OPERATOR MANUAL

Variable	Stop button [951.10]
Description	Active (1) if the button is pressed. Inactive (0) otherwise.

Variable	Start button [951.11]
Description	Active (1) if the button is pressed. Inactive (0) otherwise.

Variable	Man button [951.12]
Description	Active (1) if the button is pressed. Inactive (0) otherwise.

Variable	Test button [951.13]
Description	Active (1) if the button is pressed. Inactive (0) otherwise.

Variable	Auto button [951.14]
Description	Active (1) if the button is pressed. Inactive (0) otherwise.