



TECHNICAL DOCUMENTATION

I4GEN



CRE TECHNOLOGY
130, allée Charles-Victor Naudin
Zone des Templiers – SOPHIA ANTIPOLIS
06410 BIOT – France
Phone : +33 (0)4.92.38.86.82
www.cretechnology.com
info@cretechnology.com

TABLE OF CONTENTS

INTRODUCTION	4
User's Notice	4
Caution Safety Protections	4
Package Contents	5
Specifications	6
Presentation	9
INSTALLATION	10
Mechanical Mounting	10
WIFI Antenna Installation (Optional)	10
Power Supply	11
Network Connection	12
COMMUNICATION	13
Pre-requisite	13
Offline/Online mode	13
Login/Connection	14
Easy Connect	16
INTERFACE	21
SEARCH ENGINE	22
CONTROLLER SUPERVISION	23
Graphic Objects	23
Numerical Display	23
Numerical Display by Variable Number	23
Boolean Display (LED)	23
Bar-graph	24
Gauge	25
3D Pictures	26
Synchroscope	27
Pop-up	27
Alarm/Fault Page	29
Visualization	29
Reset/Acknowledge	30
Erase Archived Data	30
Filters	31
About Page	32
Home Page	33
Production curves	34
Scada	36
CONTROLLER SETTINGS	38
Controller dynamic settings	38
Curves	38
Parameters Configuration	39
Editing Windows	40
Numeric	40
List	41
Digital Input	41
Digital/Relay Output	42
Text	42
Password	42
Modification by Variable Number	43
Reset factory settings	43
Update controller firmware	44
I4GEN SETTINGS	45
Language	45

Screen	47
Connection	48
Network	49
Serial port	52
File Transfer	53
Remote access	54
Date/time synchronisation	57
Emails	58
Production curves	60
Restart	61
Update	61
DIMENSIONS	62

INTRODUCTION

USER'S NOTICE

Copyright of this manual belongs to the manufacturer. No part of this manual, including the products and software described in it may be reproduced, transmitted or translated into any language in any form or by any means without written permission of the manufacturer.

This manual contains all the information required for the use of this product to meet the user's requirements. It may change or be corrected at any time without notice.

The manufacturer provides this manual "as is" without warranty of any kind, and will not be liable for any indirect, special, incidental or consequential damages (including damages for loss of profit, loss of business, loss of use of data, interruption of business and the like).

Products and corporate names appearing in this manual may or may not be registered trademarks or copyrights of their respective companies. They are used only for identification or explanation and to the owner's benefit, without intent to infringe.

CAUTION SAFETY PROTECTIONS

Operate the device according to the correct installation steps and with great care to guarantee safety and comfort using experience. Please refer to the following safety instruction guide to avoid the danger of electric shock or fire. Please observe the previous safety instruction guide to use and maintain the product and the hard disk to make sure of a safe operating environment.

- Please follow the instruction manual for the operation guide.
- Make sure to use the device in the appropriate operation temperature range and humidity range.
- To avoid high temperature, please **DO NOT** overload the maximum power of the external power supply while the system is consuming high voltage. Be aware of the maximum temperature allowance of the power supply.
- Always unplug the power cable and other hardware cables from the system before cleaning.
- Use only a dry cloth to clean the product.
- Make sure that there is no heat source nearby when the product is working.
- Make sure that the thermal louver of the product is not blocked.
- Make sure to set up or use the product on a stable surface.
- Make sure not to drop the product or strike it in any way.
- Make sure not to move the product when the power is on.
- Disconnect the power cord from the **i4Gen** unit prior to any installation. Be sure both the system and all external devices are turned off. A sudden surge of power could ruin sensitive components.
- Always use the DC-DC converter provided with the unit. It provides a couple of protections, including short circuit.
- Do not open the system's back cover.

PACKAGE CONTENTS

<p>i4Gen</p> 	<p>DC-DC Adapter</p> 	<p>Power Cord</p> 
<p>X1</p>	<p>X1</p>	<p>X1</p>
<p>WI-FI Antenna</p> 	<p>Fixed Parts</p> 	
<p>X2</p>	<p>X4</p>	

Note: DC-DC Adapter 9 to 36VDC input for 12VDC output.

Environmental Protection Announcement

Do not dispose of this electronic device into the trash while discarding. To minimize pollution and ensure utmost protection for the global environment, please recycle.







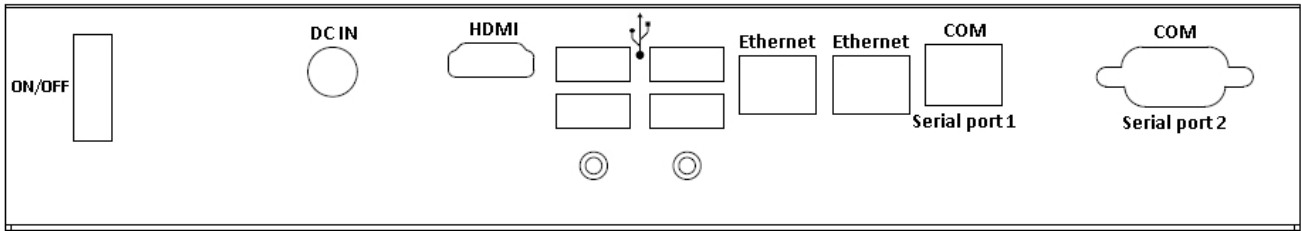

SPECIFICATIONS

Panel	
Panel spec	IP65, NEMA 4 rugged protection, Full planar metal border
Viewable Size Image	10.1" with LED back-light
Resolution	1280x800 at 60Hz
Display Color	16.2M
Pixel Pitch	0.1695 x 0.1695 mm
Aspect Ratio	16:10
Contrast Ratio	800:1
Max Brightness	400 cd/m ²
Viewing Angle (H/V)	170°/170°
Response Time	30ms
Temperature Range	-10°C ~ 60°C
Touch	
Touch Panel Type	Projected capacitive type
Active Range	257.10 x 159.66mm ±0.2mm (10.12 x 6.26 in)
Temperature Range	-10°C ~ 60°C
Transparency	> 87%
Surface Hardness	≥ 6H (JIS-5400)
Operating Force	80g
Case	
Panel Material	Aluminum
Border Material	Aluminum
Case Material	Iron
Color	Silver + white
Coating Requirement	Spray Paint
Protection grade (IP rating)	Front IP65
Cooling Mode	Fanless Fully sealed design
System Specification	
Processor	Intel® Braswell N3160, 1.60Ghz
System Chipset	Intel® Braswell N3160, 1.60Ghz
System Memory	4G 1333MHz DDR3L DRAM
BIOS	64MB SPI Flash ROM
Ethernet	2*Intel i211AT Gigabit LAN
Audio	HD Audio: Realtek ALC662VD
Storage	1* M.2 connector(2242)
WIFI Module	1* 2.4G/5G WIFI A/B/G/N/AC+BT 4.0
Display Output	HDMI
I.O Port	- 4 * USB3.0 - 2 * RS232 - 1 * HDMI1.4 - 2 * LAN (INTEL I211AT Gigabit LAN) - 1 * Locking Jack 9~36V DC input - 1 * Power button
Temperature	Operating: -10°C ~ 60°C
Humidity	20%~90% (non condensing)
Shock	Operating: 15G, 11ms duration

Vibration	Operating: 5~100Hz/1 Grms
Dimensions	268.49 * 186.50 * 59.7 mm (10.55 * 7.32 * 2.32 in)
Certification	CE, FCC, IP65(Front)
Other Information	
Special Features	Metal design, compact

I/O System

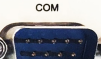

Icon	Name	Quantity	Description
	Power button (ON/OFF)	1	Press to turn On/Off the system.
	DC-in power connector	1	9-36VDC power supply input (DC-DC converter provided with the unit must be used to add electrical protections).
	HDMI port	1	To connect a display device that supports HDMI specification (not used).
	USB 3.0 port	4	To connect devices compatible with the USB specification. USB 3.0 port supports up to 5Gbps data transfer rate.
	RJ-45 LAN port (Ethernet)	2	This connector is standard RJ-45 LAN jack for network connection. Both ports are set as a bridge, acting like a switch. WARNING: Plugging both ports on a same network will result in a network loop, causing a network failure.
	RJ-45 COM port (Serial port)	1	This connector is standard RJ-45 jack used as a COM serial port. If needed, use a link which convert RJ-45 jack to a male DE-9 connector (D-Sub DB-9).
	COM port	1	This connector is a male DE-9 connector (D-Sub DB-9).

PRESENTATION

i4Gen is a user interface made by **CRE TECHNOLOGY** to offer users a complete monitoring of new **CRE TECHNOLOGY** controllers.

The unit hardware is a multi-touch screen color display developed for harsh environment and industrial areas, providing access to all controllers data for control and measurement.

With our advanced touch screen panel, it is possible to manage remote control and monitoring, through an internet access (Wi – LAN connection), with ZOHO assist© platform, and to use e-mail services, for alarms/faults management.

Control and Management

Direct display

i4Gen is able to display information from 1 to 32 controllers using the Ethernet connection and shows a basic overview of the power plant by using controller CANbus data when applicable.

Easy Connect

This function permit to quickly switch the connection between controllers. Automatically detects **CRE TECHNOLOGY** controllers on an Ethernet network. It allows to automatically configure **CRE TECHNOLOGY** controllers IP address to be able to access them with the current network configuration.

Multi user display

Several **i4Gen** can be securely connected by an Ethernet hub to a single controller (or a group of controllers). An **i4Gen** display has two Ethernet communication ports. Easy to use for redundancy application multi-level access or long-distance monitoring panel. One **i4Gen** display can also be connected to different and several COMPACT platforms.

Internet connection

With WIFI connection, or LAN cable connexion, **i4Gen** can be easily connected on internet, to manage remote monitoring or remote control, and emails management.

Events displayed/recorded

An innovative feature turns major alarms and faults into 3D graphical object display, to warn the operator about an important event and facilitate immediate diagnosis (ex: coolant tank lights up in red in case of coolant temp fault or in orange in case of coolant temp alarm).

An event alarm/fault recorder is also available on a dedicated display page, indicating timestamps, status, acknowledgment, and corresponding variable; the event page can be filtered for diagnosis and investigation of selected variables.

Compatibility

i4Gen is compatible with the following controller versions:

- **GENSYS COMPACT PRIME**: v2.10 or later
- **GENSYS COMPACT MAINS**: v2.10 or later
- **AMF COMPACT**: v2.10 or later
- **SYNCHRO COMPACT**: v2.10 or later
- **MASTER COMPACT**: v2.10 or later
- **MASTER COMPACT 1B**: v2.10 or later
- **BTB COMPACT**: v2.10 or later
- **PV COMPACT**: v2.30 or later
- **BAT COMPACT**: v2.30 or later



INSTALLATION

MECHANICAL MOUNTING

Install **i4Gen** position at eye level and at a brightness-less location.

Frame cut-out (height x width): 160x242mm (6.3x9.53in).

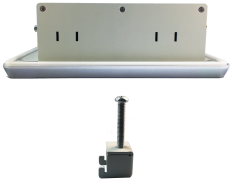
Chassis Fixed Parts

	<ol style="list-style-type: none"> 1. Insert the corresponding edges of the fixed part into the slots until they match. Make sure that the fixed part is installed as shown in the picture, with protruding tips upwards. 2. The models that support this fixing mode have slots reserved on the edges of the module's case. The user can choose the height or position of the installation spot.
	<ol style="list-style-type: none"> 3. Tighten the screw so that the fixed part can be fitted into the slots tightly. Install other fixed parts to the system in the same way.

WIFI ANTENNA INSTALLATION (OPTIONAL)

Screw the two antennas on the antenna heads connectors:

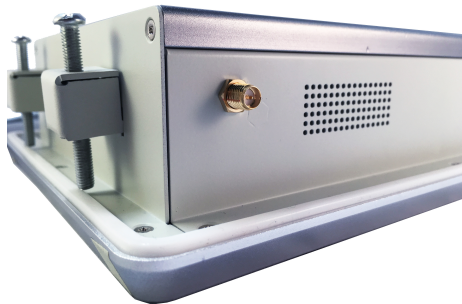

POWER SUPPLY

First make sur to turn off the power before assembling everything together.

Connect the battery to the DC-DC converter:



Note that The DC-DC converter input voltage range is 9 to 36VDC for 12VDC output. It also includes a couple of protections:

- **Short circuit**
- **Overload**
- **Over/Under voltage**
- **Input reverse polarity**

This module is not optionnal and should be used. Do not connect any DC supply directly to the touchscreen.

You can now plug the power jack in it's connector on the **i4Gen**. Make sure that you tighten it:



i4Gen is now ready to use. You can switch on the power and **i4Gen** will start automatically.

NETWORK CONNECTION

There are several possible connection types between **i4Gen** and the controller.

Direct connection

- Connect one of the Ethernet ports (RJ45-LAN) of **i4Gen** to the Ethernet port of the controller. The other Ethernet port of **i4Gen** can be connected to a network or another controller.

Connection via a Switch

- Connect one of the Ethernet ports (RJ45-LAN) of **i4Gen** to one of the ports of the switch . **WARNING:** Do not connect the other port of **i4Gen** to another port of the switch. Not following this will cause a general network failure.
- Connect the Ethernet port of the controller to one of the Ethernet ports of the switch.

You will then be able to supervise each controller, one by one, using **i4Gen**:

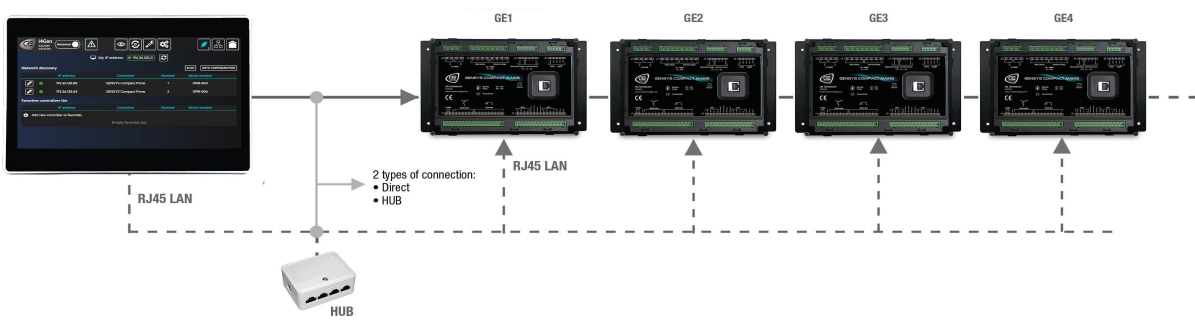

COMMUNICATION

PRE-REQUISITE

To be able to establish communication between **i4Gen** and the controller, the network addresses of both devices must be configured:

- **i4Gen** network configuration can be done from **i4Gen "Network"** settings page (see [Network](#) chapter).
- The controller network configuration can be done from the controller front panel or via **i4Gen** software.

If **i4Gen** and the controller(s) are connected directly, the network configuration of all the devices has to be compatible:

- The default IP address of **i4Gen** is: 192.168.11.50
- The default IP address of **CRE TECHNOLOGY** controllers is: 192.168.11.1

By default **i4Gen** and one controller can communicate together. Please make sure that if you change the IP addresses, the subnet mask is set accordingly.

OFFLINE/ONLINE MODE

i4Gen can be used in offline/online mode.

Offline Mode

The controller's display and controller's setting menus are not available. You can only access the about page, i4Gen settings, Easy Connect and manually connect to a controller.

Online Mode (connected to a controller)

Controller's display and controller's setting menus are now available.

i4Gen is synchronized with the controller:

- The pages reflect the controller's measures, configuration, alarms/faults...

The controller's parameters configuration is done in real time and they are sent one by one in most cases.

LOGIN/CONNECTION



Press "**Login/connection**" icon to open login/connection window.
i4Gen uses the classic password system of the **CRE TECHNOLOGY** modules for access rights and parameter modification of the connected module.

Level	Default password	Rights	Menu
0	None	None	Display and manual button
1	1	User settings	All menus
2	CRE Technology reserved distributor	Advanced settings	All menus

Connection window in offline mode:

To connect to a module, you have to fill the following information:

- The IP address of the controller.
- The Modbus/TCP port of the controller.
- The HTTP port of the controller.
- A password according to your needs.

Once you have filled this information, push the button



to connect and log in with the entered password.

Once you are connected, you will always be synchronized with the controller.

Once logged in, you can change the login password level by changing the "**Password**" field and pressing the button:



Passwords are the same as those used to connect directly to the module via its front panel or embedded website.

It is possible to disconnect by pressing the button:



When the connection to the controller is lost, **i4Gen** attempts to reconnect to the remote controller for several seconds and then stops after a while.

During reconnection attempts, the



button is replaced by a



button

Connection window in "**Connection in progress...**" mode:

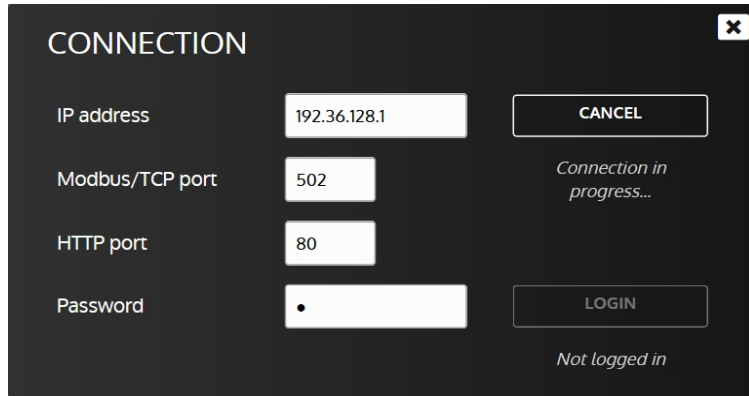

To disconnect a module from **i4Gen**, open the connection window then press the button:



Connection window in "**Connected**" mode:

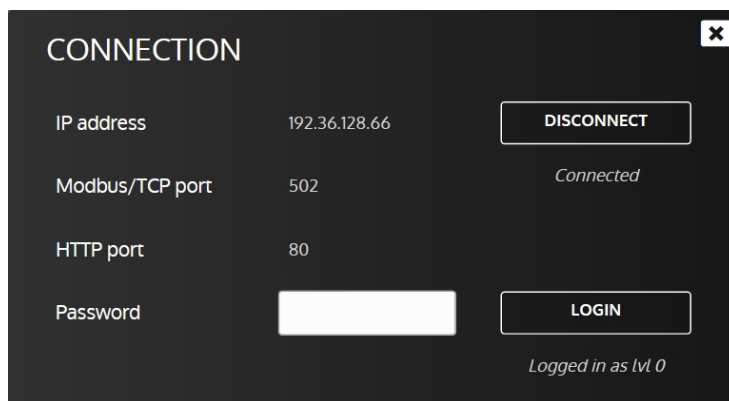

EASY CONNECT

Easy connect function has three main purposes:

- Automatically detects **CRE TECHNOLOGY** controllers on an Ethernet network
- Allow to quickly switch the connection between controllers
- Auto configure **CRE TECHNOLOGY** controllers IP address to be able to access them with the current network configuration.

Interface

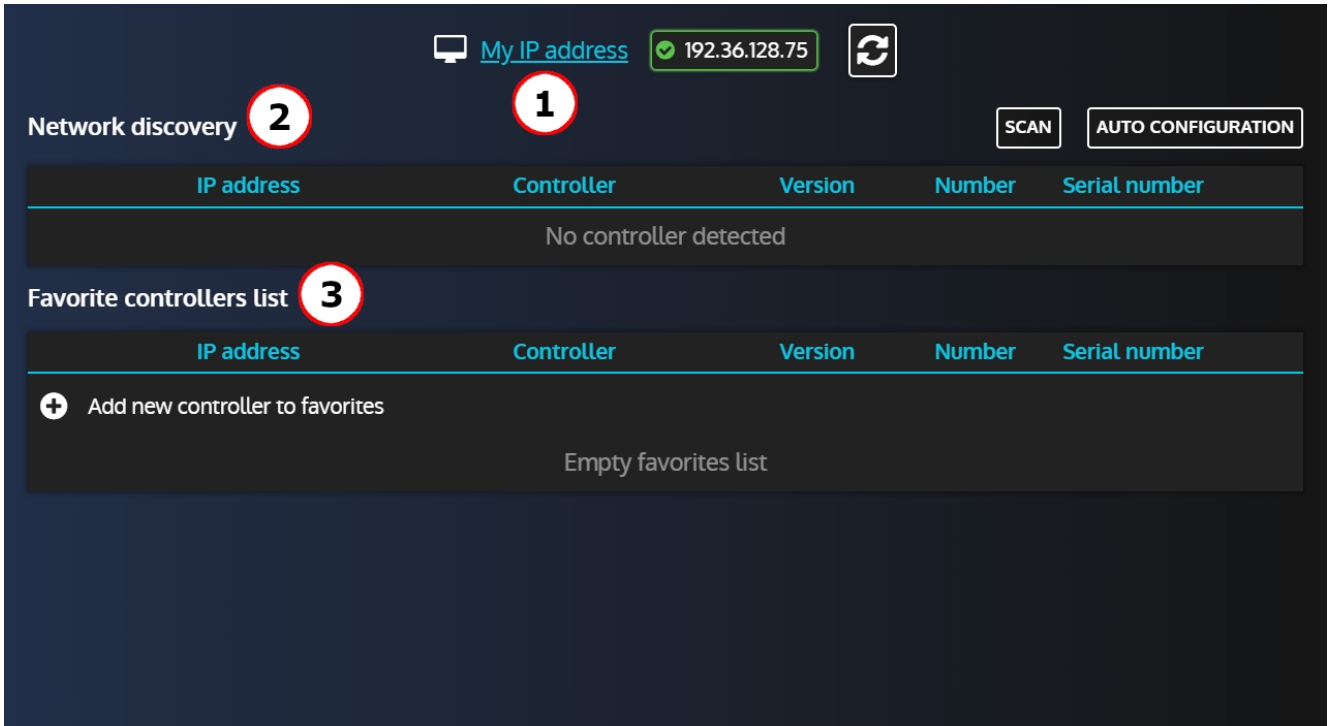

1. Display current **i4Gen** IP address. Pressing  will refresh the list of available IP addresses.

2. The "**Network discovery**" section will display all **CRE TECHNOLOGY** controllers automatically found on the network and allow to connect to them. The "**Scan**" button allows to refresh the list of controllers and the "**Auto configuration**" button will automatically configure detected controllers according to the **i4Gen** IP settings to ensure that it can connect to them.

Note that if a controller's IP settings already allow a connection in their current state, **i4Gen** will not change them.

3. The "**Favorite controllers list**" allows to manually add a controller. Both "**Scan**" and "**Auto configuration**" buttons have no impact on the controllers in this list.

You will also be able to connect to the controllers in this list (only if the **i4Gen** IP settings matches).

Network discovery

When entering the page, **i4Gen** will automatically scan the network to find controllers:

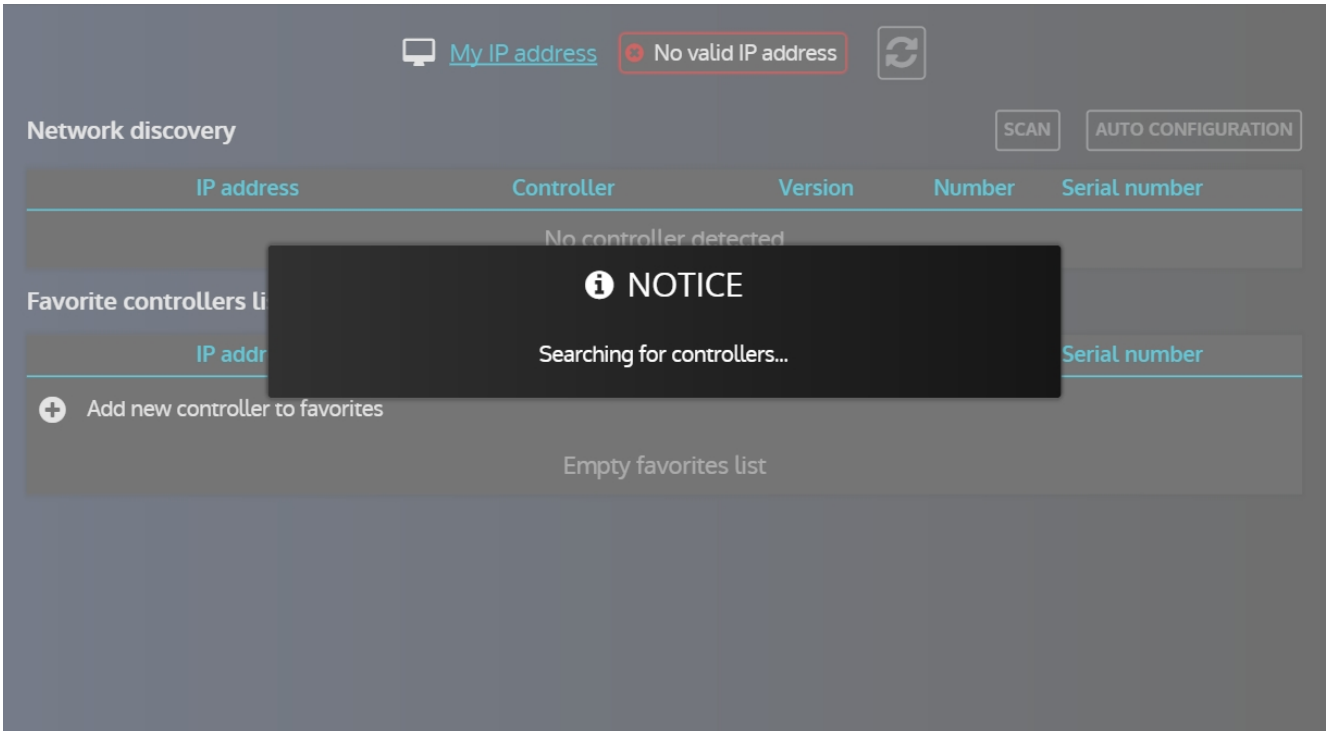

And display the controllers found:

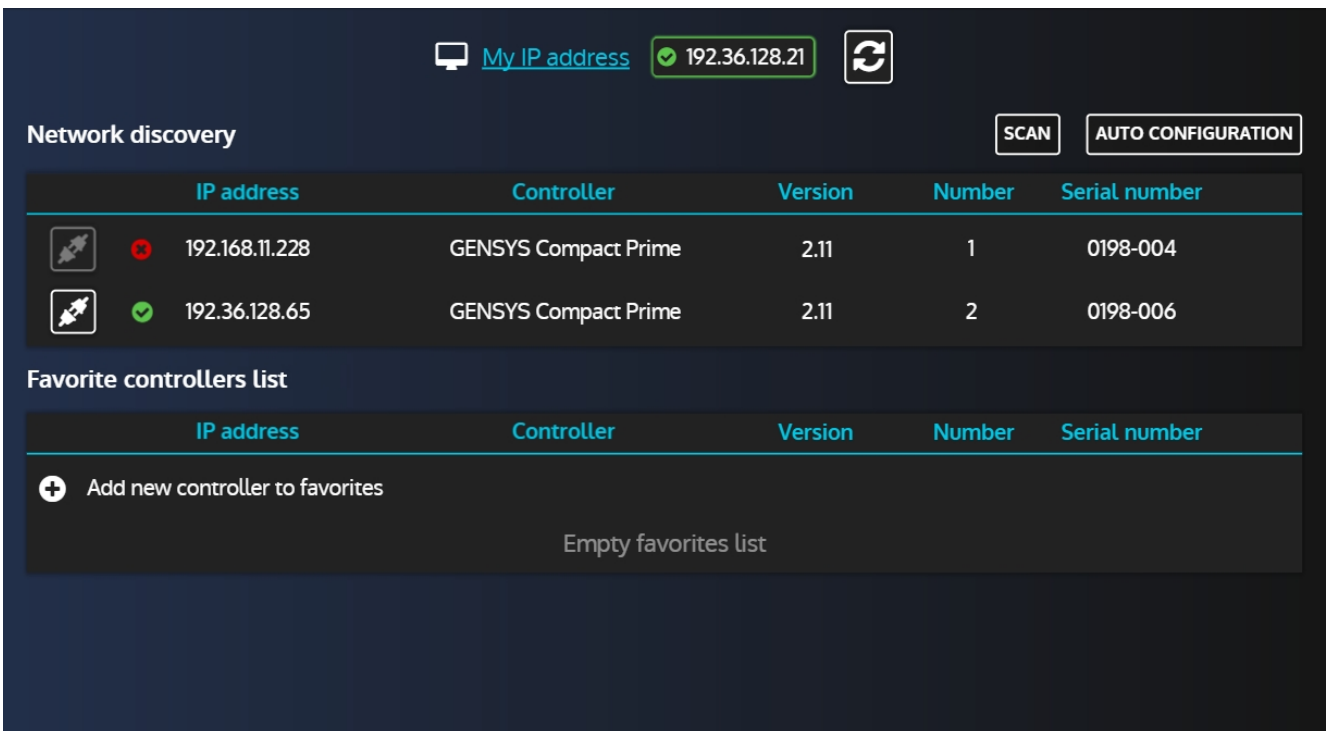

In the list, we can see that one controller has a red cross next to it and the  is disabled. This is because its current IP settings doesn't match ours thus it is not possible to connect to it.

Pressing the "Auto configuration" button will resolve this situation for us:

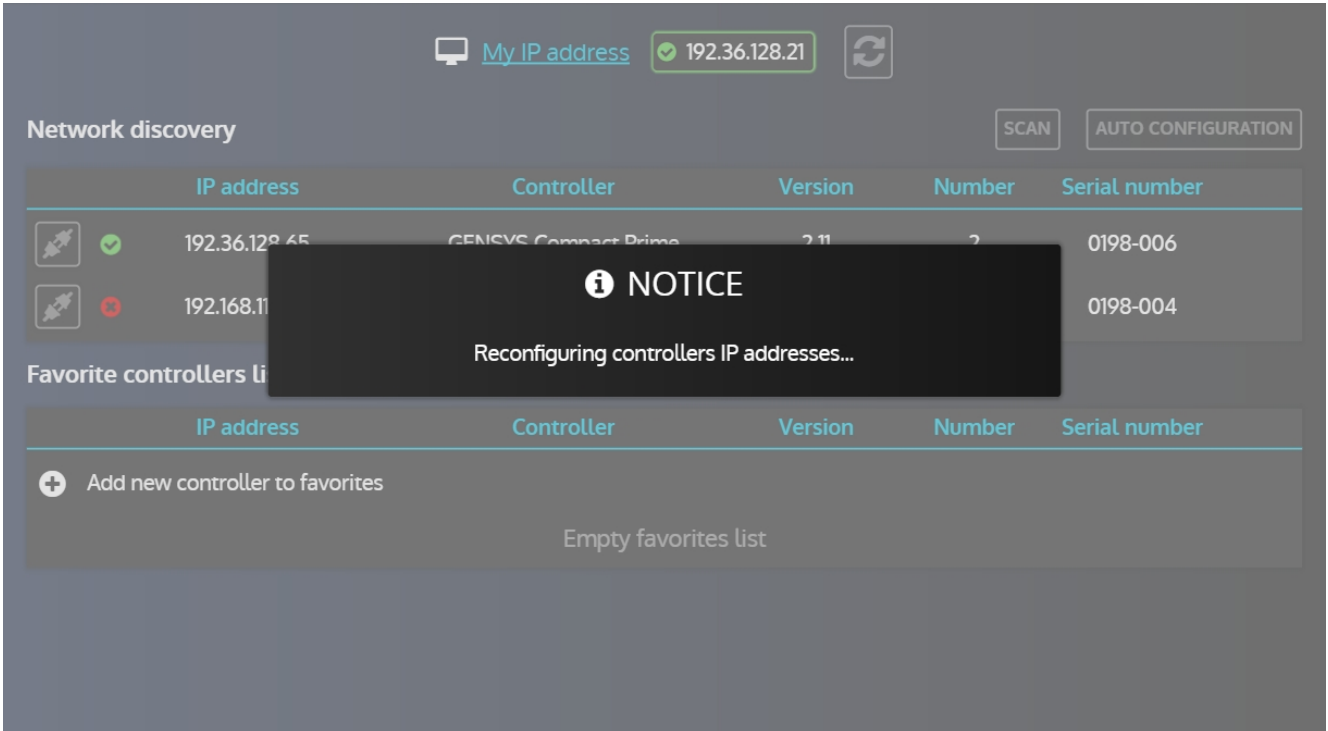

Note that you'll be prompted to validate the auto configuration before it starts.



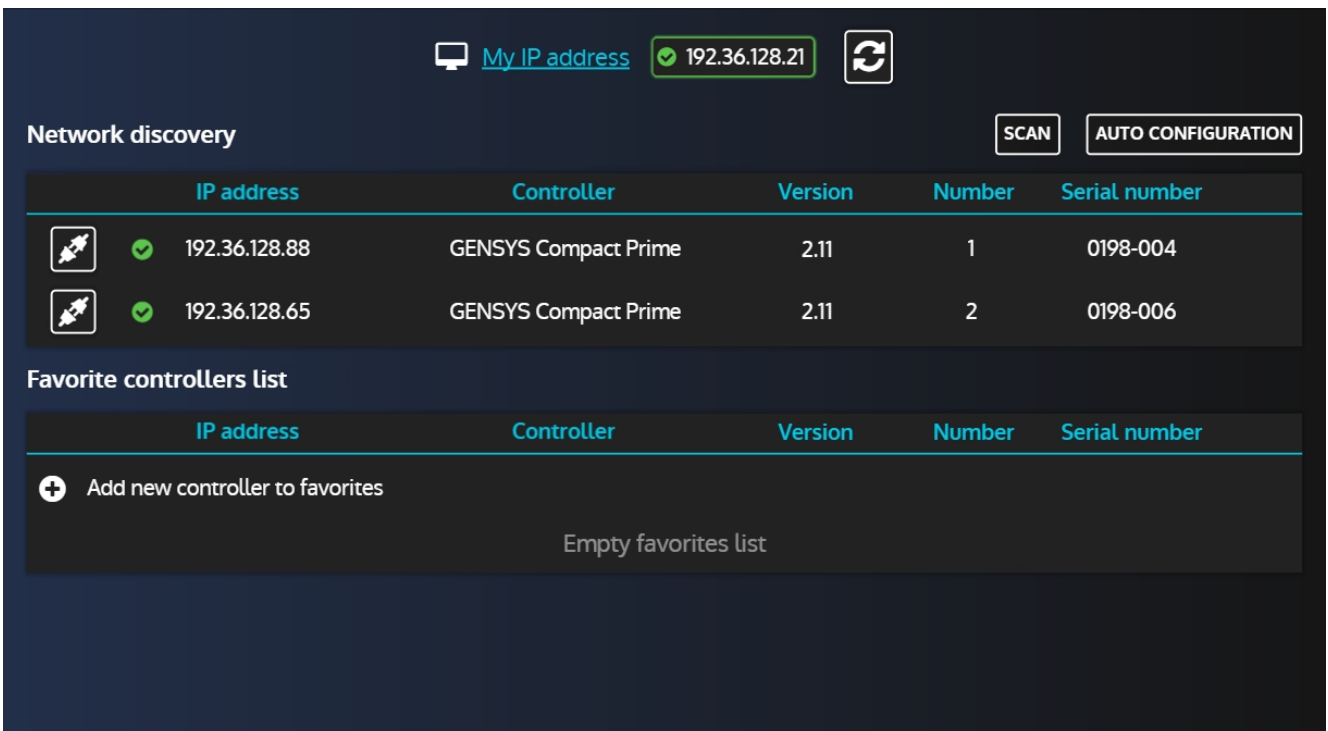

After a few seconds, the auto configuration is done and both controllers are now green:

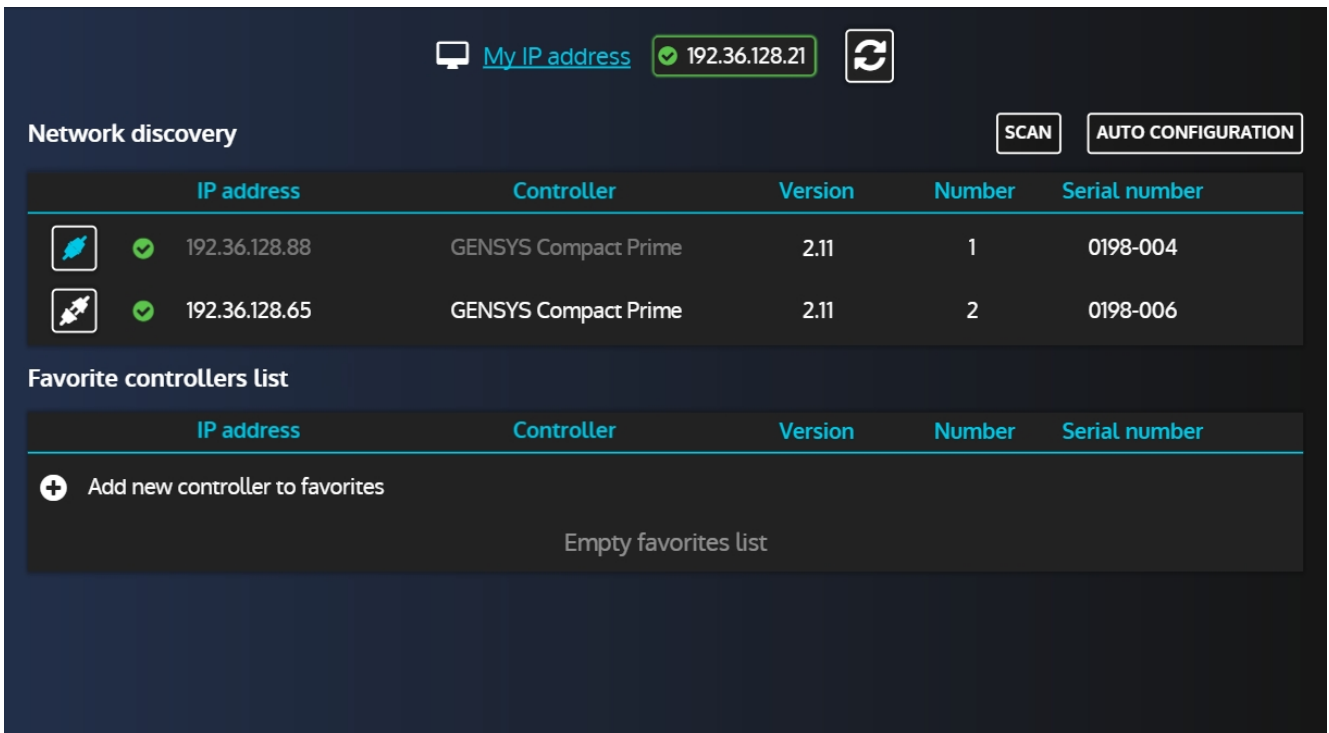

Using the  button, we can now connect to one of the controllers:



The screenshot shows a network discovery interface. At the top, there is a "My IP address" field with a checkmark and the value "192.36.128.21", and a refresh icon. Below this, there are two buttons: "SCAN" and "AUTO CONFIGURATION". The main section is titled "Network discovery" and contains a table with the following data:

	IP address	Controller	Version	Number	Serial number
	 192.36.128.88	GENSYS Compact Prime	2.11	1	0198-004
	 192.36.128.65	GENSYS Compact Prime	2.11	2	0198-006

Below the table is a section titled "Favorite controllers list" with a table that is currently empty. A button labeled "Add new controller to favorites" is visible at the top left of this section. The text "Empty favorites list" is centered below the table.

Note that you'll be prompted a password.

Favorite controllers list

You can add a controller by pressing the  button:

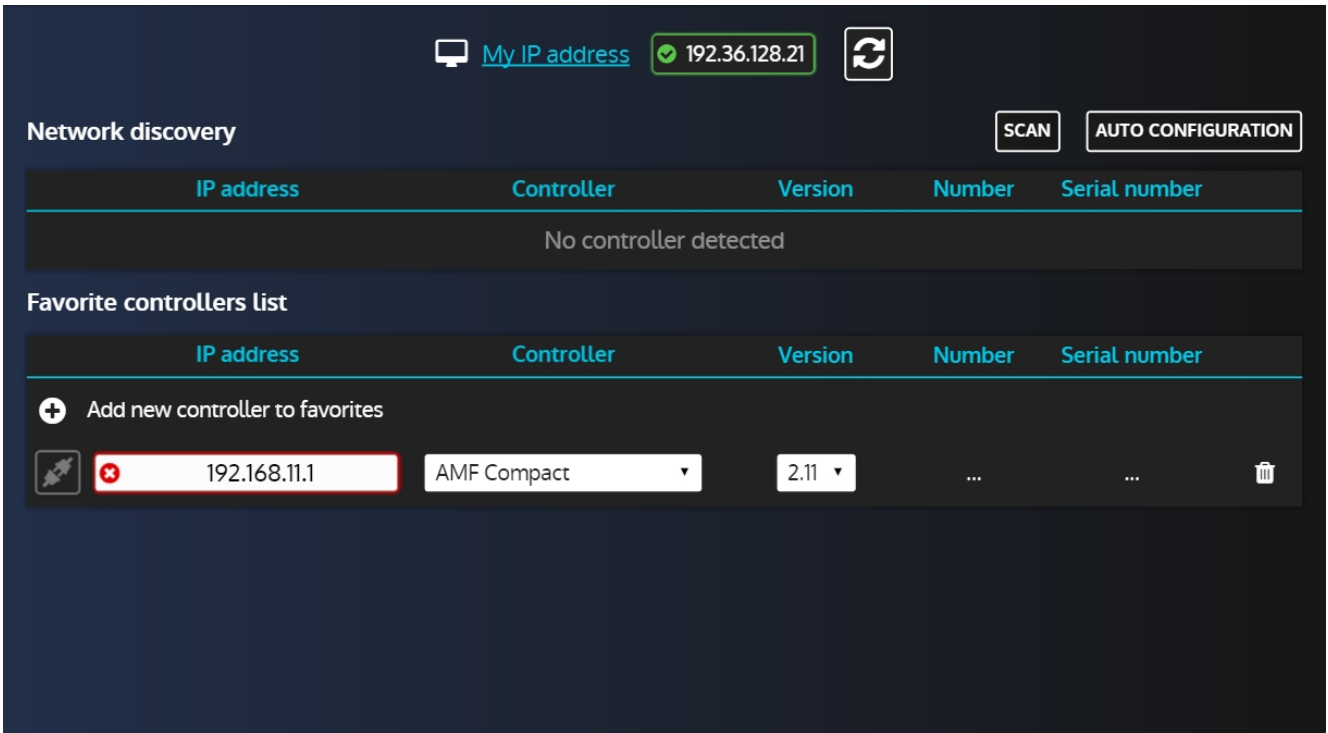

My IP address 192.36.128.21 

Network discovery SCAN AUTO CONFIGURATION

IP address	Controller	Version	Number	Serial number
No controller detected				

Favorite controllers list

IP address	Controller	Version	Number	Serial number
+ Add new controller to favorites				
 192.168.11.1	AMF Compact	2.11

Note that, as stated previously, there will be no automatic actions for the elements in this list. If there is a red cross next to the controller's IP address, you'll have to either adjust the **i4Gen** IP settings or the controller's IP setting to be able to connect to it.

The Favorite controllers list is part of the user configuration thus it is saved and you'll keep the list after restarting **i4Gen**.

INTERFACE

The **i4Gen** interface replaces the front panel of the **CRE TECHNOLOGY** controllers and offers a better ergonomomy to facilitate the supervision of our products.

Header

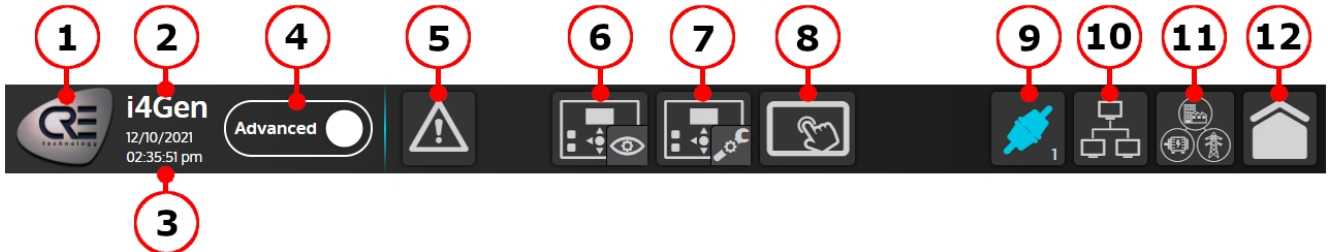

1. **CRE Logo:** Press this button to open "about" page.
2. **Product name.**
3. **Date/Time:** The date/time displayed on i4Gen is the date/time of the connected controller.
4. **Configuration mode:**
 - o Standard: Only the most important parameters of the controller are available.
 - o Advanced: All the parameters of the controller are available.
5. **Alarms/Faults page:**
 - o Blinking in orange/red means there is atleast one unacknowledged alarm/fault.
 - o Static means there is atleast one alarm/fault acknowledged and in progress.
 - o Press this button to open alarms/faults page.
6. **Controller supervision menu:** Press this button to open the supervision menu where you can access all supervision pages.
7. **Controller settings menu:** Press this button to open the controller settings menu where you can access all the pages that contain controller parameters. You must be logged at least in level 1 to access this button.
8. **i4Gen menu:** Press this button to open the i4Gen menu where you can access all the pages that contain i4Gen settings.
9. **Connection/Login button:** The connection icon shows the connection state (connected/disconnected) and the number below shows the login level. Press this button to open the connection/login window in order to connect to a controller.
10. **Easy Connect page:** Press this button to open the Easy Connect page where you can automatically detect the available controllers and easily switch the connection between them.
11. **Scada page:** Press this button to open the Scada page that displays a complete diagram of the powerplant.
12. **Home page:** Press this button to open the home page. This is a dynamic page that display a different content according to the current controller engine/power state.

Footer

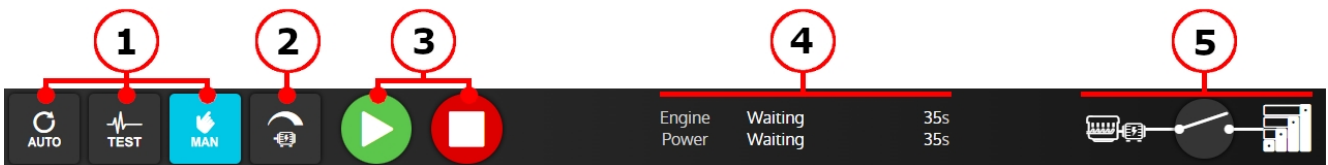

1. **Controller mode buttons:** Press one of this button to change controller functioning mode (auto/test/man).
2. **Alternator control button extension:** Press this button to open a tab width additional buttons for manual frequency/voltage control. Only available in manual mode.
3. **Start/Stop buttons:** Press these buttons to start/stop the generator. Only available in manual mode.
4. Engine state, Power state and states timers of current connected controller.
5. Synoptic of current selected/connected controller.

SEARCH ENGINE

In several pages of **i4Gen**, a search engine is available to search for a controller variable.

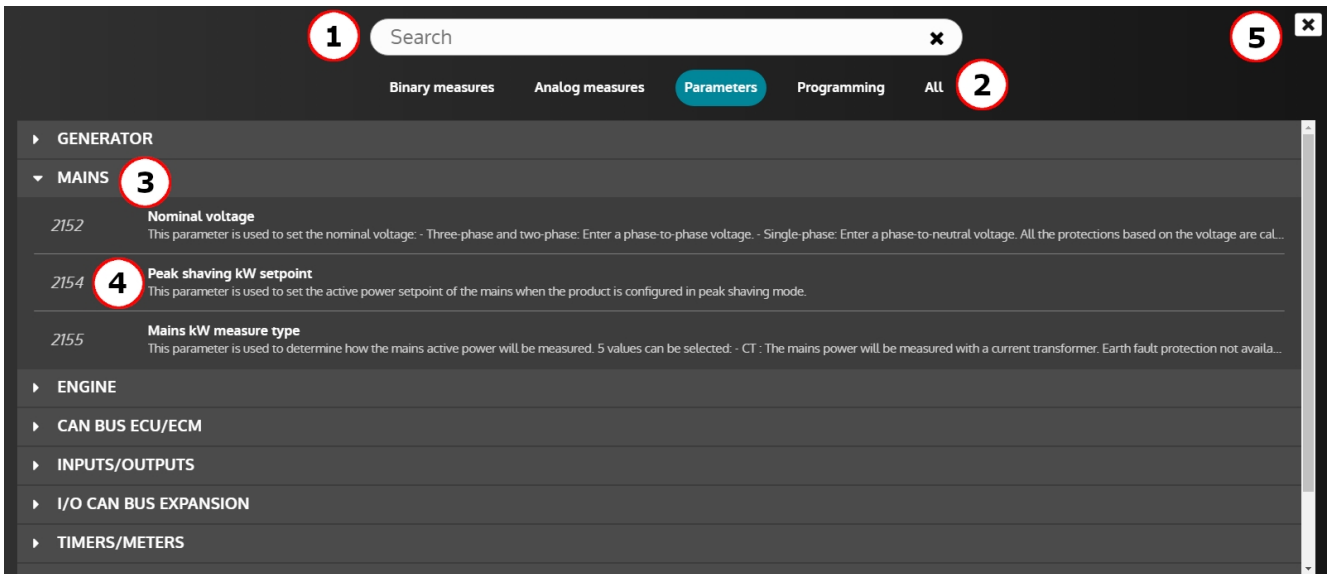

- Search bar:** Type part of the label or address of a variable and press enter or leave the input to find the matching result
- Categories:** The variables are organised into 4 categories. Select a category to display the matching variables:
 - Binary measures: measures with a value range from 0 to 1
 - Analog measures: measures with a value range different from 0 to 1
 - Parameters: all the parameters excepted the user variables and the input functions
 - Programming: the user variables and the input functions
 - All: Combine all of the above
- Sections:** The variables displayed are arranged in several sections:
 - The sections are collapsed by default
 - Press a section to expand it
 - Press an expanded section to collapse it
- Variable:** Each variable displayed shows its address, label and description (if the description is too long, hover it to display the full description). Press a variable to select it.
- Close button:** Press the close button to close the search engine

Note: Depending on the page, the search engine may display more or less variables to fit the user's need.

In some pages (*Easy Flex®* and *Alternative selection*), the search engine is used to add/remove multiple variables to the workspace.

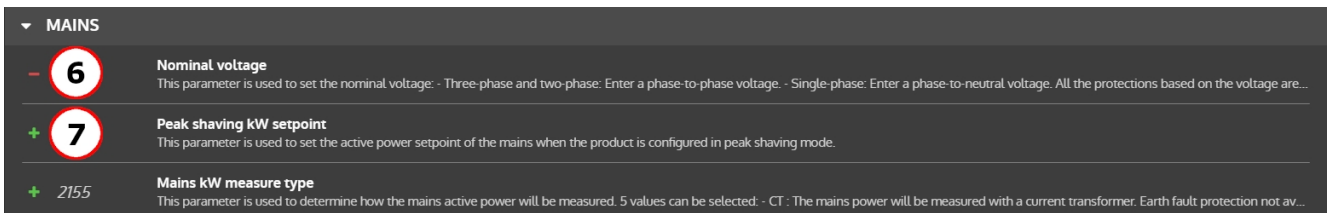

- Removing a variable:** Press a variable with a red "-" icon to remove it from the workspace
- Adding a variable:** Press a variable with a green "+" icon to add it to the workspace

CONTROLLER SUPERVISION



"Controller supervision" part displays controller measures in real time. Select the supervision icon to open the menu that gives access to all controller supervision pages.

GRAPHIC OBJECTS

i4Gen offers several graphical objects to display the different measures of the connected controller in order to offer an ergonomic, dynamic and aesthetic display.

NUMERICAL DISPLAY

Composition: label + value + unit (not that in this case, there is no unit for this parameter):



This is the simplest graphical object of the application, but also the most effective for displaying a large number of measures on the screen.

NUMERICAL DISPLAY BY VARIABLE NUMBER

Composition: label + editable address field + value + unit:



This is the graphic object used in the "Info" page of **i4Gen**. It allows you to search for a controller's variable through a search engine to display its label, value and unit.

The variables of the "Info" page are automatically saved when a variable of the page is changed. Each controller type has its own custom "Info" page.

Note that this page is local to **i4Gen** and doesn't reflect the controller's Info page.

BOOLEAN DISPLAY (LED)

Composition: label + LED:



This is the graphic object used for most boolean (binary) variables.

LED color codes:

- Green: Active
- Grey: Inactive

BAR-GRAPH



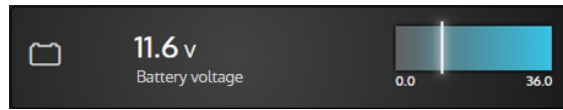

The bar-graph displays graphical information on generator mechanical measures (from a minimum to a maximum):



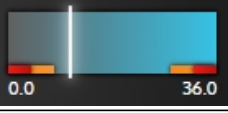

Note: The slider is the value of the measurement relative to the min and max shown below the bar-graph.

User Configuration Reminder

The protection levels configured for the measurement associated with the bar graph are directly represented on the bar graph:

	Representation of a minimum protection threshold configured as an alarm.
	Representation of a maximum protection threshold configured as a fault.
	It is possible to display up to two maximum and two minimum protection thresholds per bar-graph.
	If no protection is configured, no threshold will be displayed on the bar-graph.

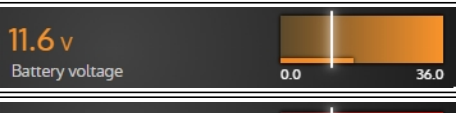
Bar-graph States

	Nothing to report: When the cursor remains outside of the alarm/fault ranges or no protection threshold has been configured, the background of the bar-graph is colored with the selected theme and the numeric value on the left side of the bar-graph is white colored.
	Alarm active: When the cursor overlaps an alarm range, the bar-graph and its numeric value turn into orange color.
	Active fault: When the cursor overlaps a fault range, the bar-graph and its numerical value turn into red color.

GAUGE

This is the graphic object used for electrical measures and whose representation of the measure with respect to a minimum and a maximum is important:

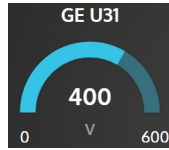

Note: The gauge fill part corresponds to the value of the measurement with respect to the minimum and maximum indicated below the gauge.

User Configuration Reminder

The protection levels configured for the gauge associated measure are directly represented on the gauge:

	<p>Representation of a minimum protection threshold configured as an alarm.</p>
	<p>Representation of a maximum protection threshold configured as a fault.</p>
	<p>It is possible to display up to two maximum and two minimum protection thresholds per gauge. If no protection is configured, no threshold is displayed on the gauge.</p>

States of the Gauge

	<p>Nothing to report: When the gauge fill part remains out of the alarm/fault ranges or no protection threshold has been configured, the gauge background is colored with the selected theme and the gauge numerical value is white colored.</p>
	<p>Alarm active: When the gauge fill overlaps an alarm range, the gauge fill part and its digital value turn into orange color.</p>
	<p>Active fault: When the gauge fill overlaps a fault range, the gauge fill part and its numerical value turn into red color.</p>

3D PICTURES

Some pages of supervisions display 3D pictures that change according to the state of the associated protections in each of these pages.

Engine/Battery

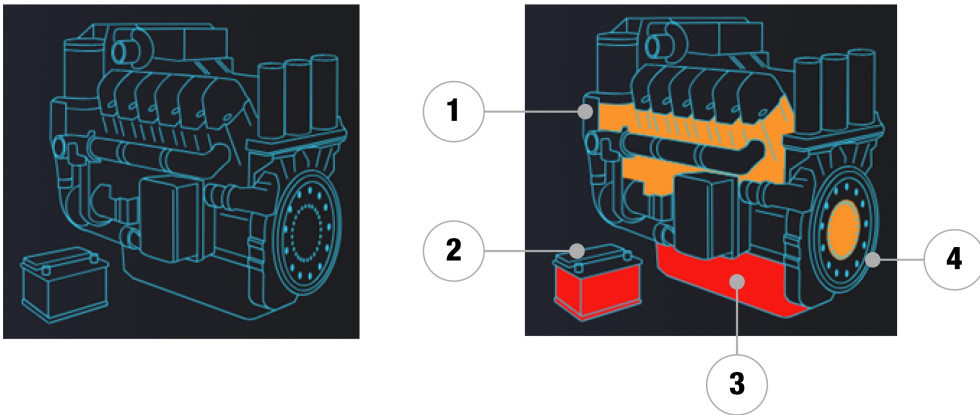

1. Indicates the presence of a water temperature alarm/fault.
2. Indicates the presence of a battery voltage alarm/fault.
3. Indicates the presence of an oil pressure alarm/fault.
4. Indicates the presence of an engine speed alarm/fault.

Alternator

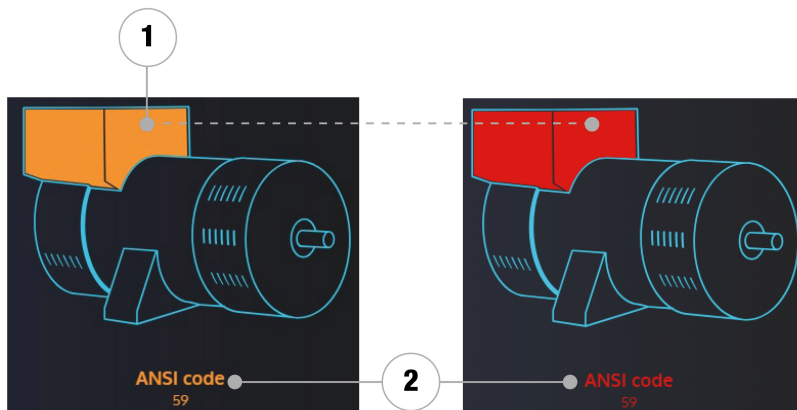

1. Indicates the presence of a generator electrical alarms/faults.
2. Indicates the ANSI code(s) of the alarms/faults present on the generator.

Note: The color of the fault has priority over the color of the alarm.

Mains

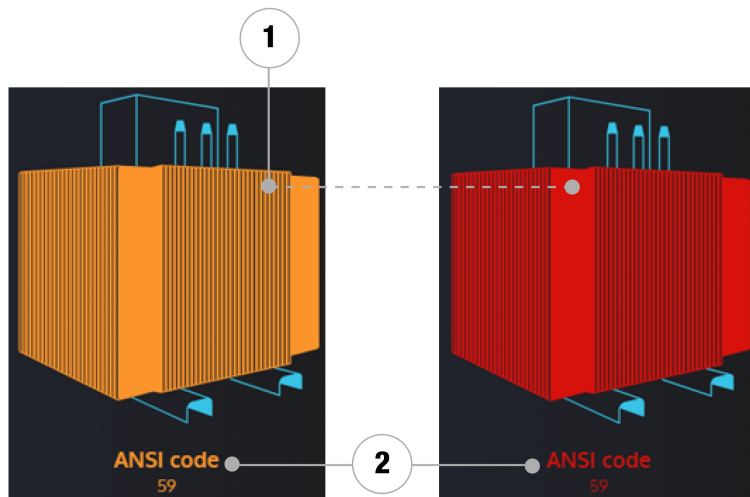

1. Indicates the presence of a mains electrical alarms/faults.
2. Indicates the ANSI code(s) of the alarms/faults present on the mains.

Note: The color of the fault has priority over the color of the alarm.

SYNCHROSCOPE

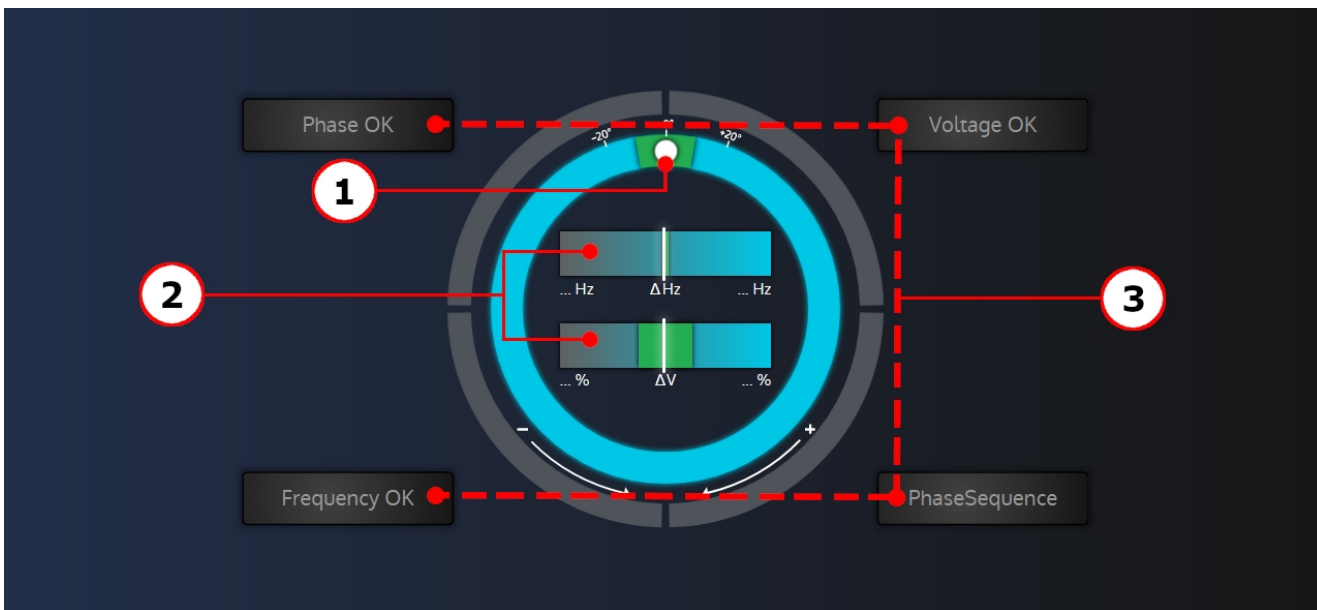



This is the graphical object used in the **"Synchronization"** page of **i4Gen**. It allows, during synchronization, to visualize the phase, frequency and voltage differences between the generator and the mains/bus-bar as well as the synchronization conditions.

1. The position of the white circle indicates the phase shift (from -180° to $+179^\circ$) between the generator/power plant and the mains/bus-bar. The green area displayed on the phase circle indicates the maximum phase deviation accepted to allow the circuit breaker to close.
2. In the bar-graphs located in the center of the synchroscope, the cursor position represents the frequency/voltage difference between the generator/power plant and the mains/bus-bar. The green area displayed on each bar-graph indicates the maximum frequency/voltage deviation accepted to allow the circuit breaker to close. If the frequency difference is too high, the cursor becomes red colored and the phase measure (white circle) is not displayed anymore.
3. The four dials around the phase circle represent the synchronization conditions. Each dial is:
 - Colored in grey if the condition is not respected.
 - Colored in green if the condition is respected.

POP-UP

i4Gen can display pop-up windows to give information to the user.

There are three kinds of pop-up windows:













	Notice: Display an information message.
	Warning: Display a warning message.
	Error: Display an error message.

ALARM/FAULT PAGE

	<p>Select the "alarms/faults/events" icon to open alarms/faults/events page and stop the controller's horn.</p> <p>When i4Gen is connected to the module, this page allows you to view the alarms/faults/events of the controller and acknowledge/reset the active alarms/faults.</p>
---	---

VISUALIZATION

Alarms/Faults/Events history

DATE	HOUR	TYPE	STATE	N°	LABEL	ANSI
02/05/20	15:56:43		OFF	4203	Battery maximum voltage	
02/05/20	15:56:23		ON	4203	Battery maximum voltage	
02/05/20	15:55:35		OFF	4250	Generator over frequency	81H
02/05/20	15:55:21		ON	4250	Generator over frequency	81H
02/05/20	15:54:22		OFF	4252	Generator over voltage	59
02/05/20	15:54:07		OFF	252	Emergency stop	
02/05/20	15:53:38		ON	252	Emergency stop	
02/05/20	15:53:38		ON	4252	Generator over voltage	59
02/05/20	15:53:38		ON	600	Isolated product (sees nothing on CAN bus)	
02/05/20	15:53:38		ON	5009	Manual mode	
02/05/20	15:53:38		ON	5006	Generator breaker opened	
02/05/20	15:53:38		ON	5002	Engine stop	

The alarms/faults/events history is displayed as a table, from the most recent alarm/fault to the oldest one.

Each line in history shows the following information:

1. Date of event activation.
2. Time of event activation.
3. Event type: alarm (orange), fault (red) or event (white).
4. Event status: On or Off (for events, only the On state is recorded).
5. The variable number corresponding to the event.
6. Event label.
7. Ansi code of the protection (if applicable).

Active alarms/faults/events

DATE	HOUR	TYPE	STATE	N°	LABEL	ANSI
02/05/20	16:01:21		ON	4203	Battery maximum voltage	
02/05/20	16:01:15		ON	4252	Generator over voltage	59

The current active alarms/faults can be displayed.

The red lines correspond to active faults and the orange lines correspond to active alarms.

RESET/ACKNOWLEDGE**Reset/acknowledge button****Actions:**

- Reset alarms/faults that are no longer active.
- Inform the **i4Gen** that alarms/faults have been acknowledged.

Alarm/fault acknowledgment status:

- When alarms/faults are active and have not been acknowledged, the alarm/fault panel blinks red/orange.
- When alarms/faults are active and have been acknowledged, the alarm/fault panel has a fixed color.

ERASE ARCHIVED DATA**Erase archived data****Action:**

- Erase controller recorded alarms/faults/events and archived data.

Note: This function is available only if connected with level 2 password.

FILTERS

Several filters are available to filter the display of the alarms/faults/events table.

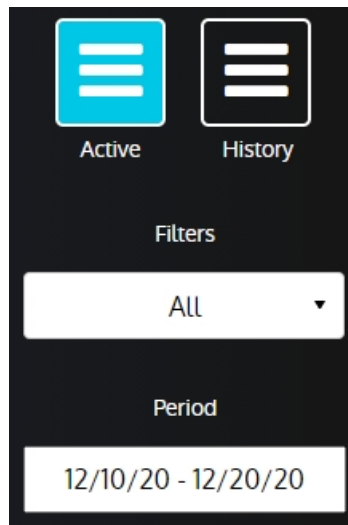

Example of filter configuration: display of active alarms from 12/10/2020 to 12/20/2020

Description of filters:

- Active/History: You can choose to display either the current active alarms/faults, or the alarms/faults/events history of the controller.
- Filters: You can chose to enable/disable several filters:
 - Select all: to enable/disable all filters
 - Events: to display or not the controller's events
 - Alarm: to display or not the controller's alarms
 - Fault: to display or not the controller's faults
 - Date: to display or not the period filter field

Note: You can mix up filters as you wish.
- Period: If the period filter is enabled, you can use this field to filter the alarms/faults/events according to a specific date range.

ABOUT PAGE

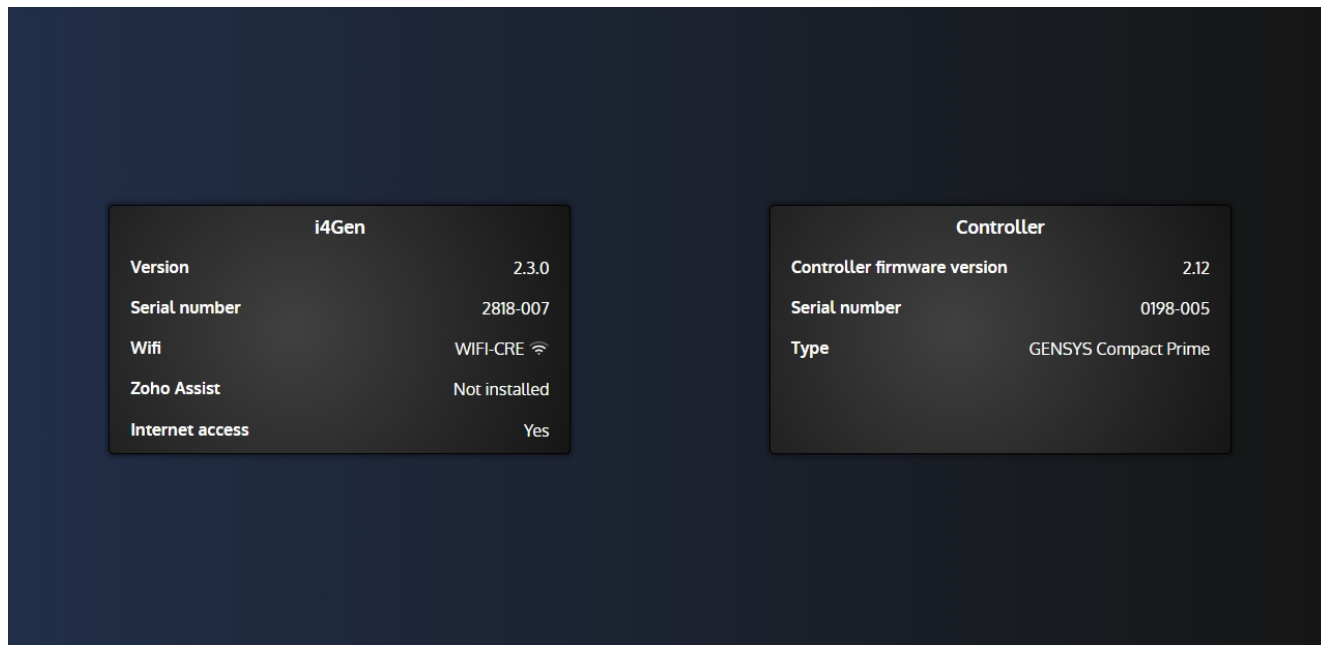
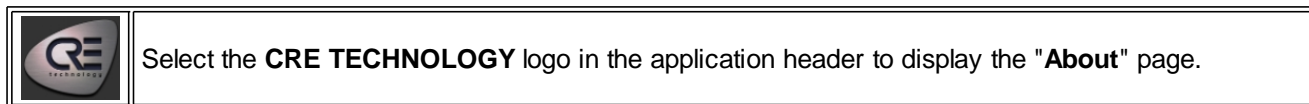

This page displays:

1. An **i4Gen** section with:
 - The software version.
 - The serial number of **i4Gen**.
 - The WIFI connection state (enabled or disabled or if **i4Gen** is connected to a WIFI network, its SSID and the signal strength).
 - The Zoho Assist installation state.
 - The Internet access: **i4Gen** can access Internet through:
 - an Ethernet connection
 - a WIFI network
 - a smartphone connected through USB in modem mode.

In all cases, the end device **i4Gen** is connected to should have an Internet access to share with it.

2. A controller section with:
 - The firmware version of the controller.
 - The serial number of the controller (if connected to a controller).
 - The type of controller connected to **i4Gen**.
 - The active options of the controller (optional)

HOME PAGE



Select home icon to open "**Home**" page.

Offline Mode

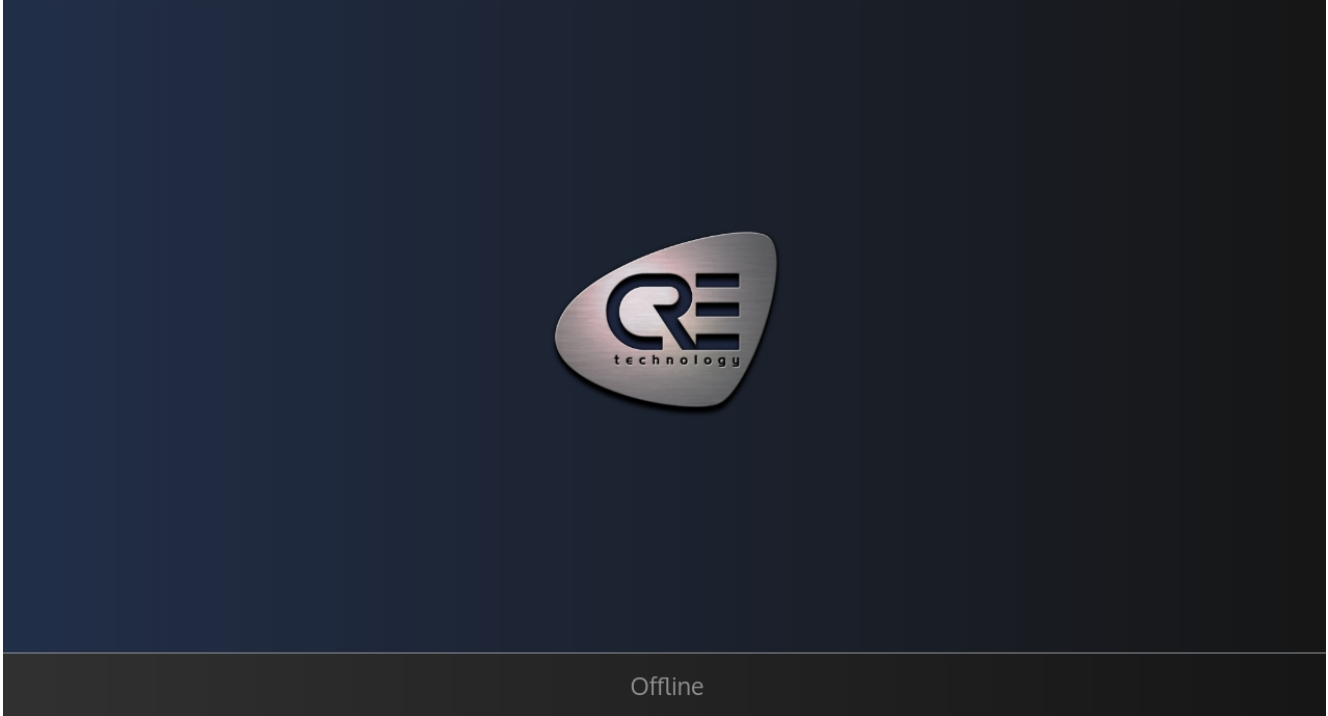

In offline, the home page simply shows **CRE TECHNOLOGY** logo.

Online Mode (Connected to a Controller)

In online mode, home page is a dynamic page whose content changes according to the controller's internal state machine.

PRODUCTION CURVES

First, make sure that the production curves are enabled in the **i4Gen** settings.



Select "**Production curves**" from "**Controller supervision**" Menu.

Note that the graph will only appear when there is atleast two points to display. Otherwise, it will display the following message: "No curves data, refresh the page to display new data".

 **WARNING**



The i4Gen will only record data as long as it is connected to a compatible controller. No specific user level is required so you can simply login as a level 0 user. The i4Gen will record as long as it is connected even if the password expiration triggers.

The Production curves page is always available, even if not connected to a controller as long as the feature is enabled.

INTERFACE



1. Graph zone where the curves are displayed. You can select a specific point by touching it on any curve. Its information (date and value) will be displayed near **2**.
2. Hide/display each available controller datas by using the checkboxes.
3. Allows to alternate between kVAR and kW display.
Stack mode allows to view the power production as a single element and see how much each type of source (generators, photovoltaic cells, Mains and batteries if applicable for your application) is contributing to the total power produced at any given time.
In Stack mode:
 - o The curves will always be stacked in the following order: batteries, Mains, generators, then photovoltaic cells.
 - o The curve that is on top of everyone else will always show the total power produced.
4. Filter the data displayed between two dates using a calendar to input each date.
Note that you if you wish to filter data within a same day, you can use the "Select Time" button to input a

time on top of the date in the calendar.

5. Filter the data displayed between two dates using the zoom bar.

Note that once you defined a certain zoom level by moving both cursors, you can swipe with your finger in the space between both cursors to change the date range of data displayed while keeping the zoom level.

SCADA



Select the scada icon to open the "**Scada**" page (available only for controllers that manage multi-controller applications: GENSYS COMPACT PRIME, MASTER COMPACT, MASTER COMPACT 1B, BTB COMPACT, PV COMPACT, BAT COMPACT).

The **Scada** page displays a complete diagram of the powerplant (including **CRE TECHNOLOGY** controllers). **i4Gen** automatically build the Scada display without any user intervention needed as long as few conditions are met:

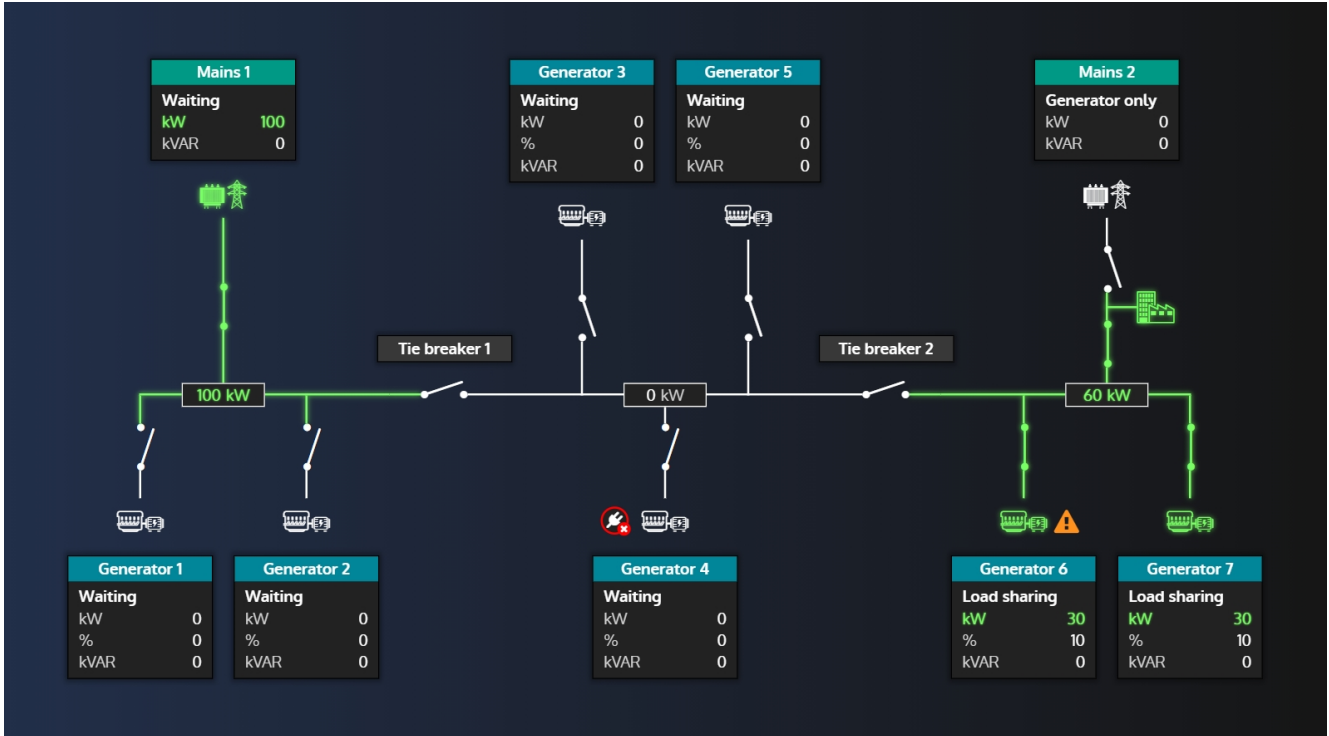

Conditions

To display the **Scada** view of a powerplant, certain conditions must be met:

- **i4Gen** must be connected to a controller.
- The number of controllers set must be greater than one and properly assigned for each controller of the powerplant.
- All the controllers of the powerplant must be connected via CAN bus.
- The controller which **i4Gen** is connected to must not have an active CAN bus fault.

Controller information

For each controller, the following information are available (may vary depending on the controller type):

- Power state
- Active power in kW and %
- Reactive power in kVAR.
- A warning sign  indicating the presence of an active alarm (orange blinking), an active fault (red blinking), or both (alternatly blinking orange/red).
- The type of voltage source represented by an icon and its "supplied" state (green = power supplied, white = not supplied).
- The breaker(s) and their state (opened/closed).

Bus information

There is additional informations available related to the bus bar:

- Tie breakers that seperate each segment of the powerplant (if any).
- Active power in kW for each segment.
- Supplied state of each wire of the bus bar (green = power supplied, white = not supplied).

EasyConnect

The **Scada** page can be used to easily/quickly switch connection between controllers.

In order for the function to be available, each controllers must be connected to an Ethernet switch and the Ethernet settings must be set accordingly.

To switch to another controller, simply click on the desired controller block.

The current connected controller is highlighted with its associated theme color.

Controllers matching one of the following conditions will not be available through EasyConnect:

- There is a network configuration mismatch between **i4Gen** and the target controller.
- Two controllers of the same type have the same product number and are on the same Ethernet network.

Thus, they will be signaled by a plug icon with a red cross: .

Note: If the controllers of two separated powerplants are connected to the same Ethernet network, the subnet mask of the controllers must be set in order to have the two powerplant in different sub networks. In that case, please contact your network administrator to make the correct configuration.

Example of a SCADA view of a photovoltaique and battery storage powerplant:

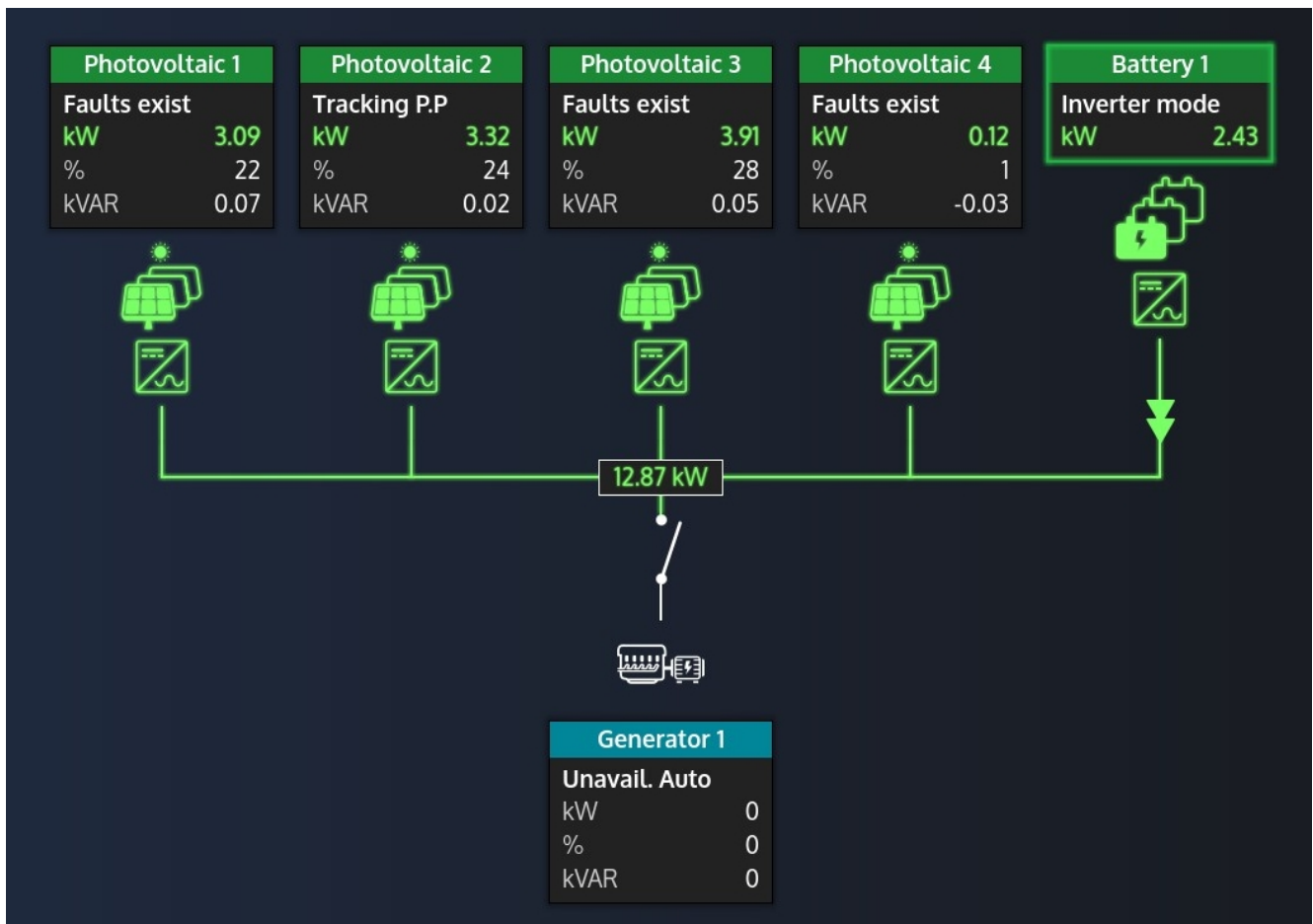

CONTROLLER SETTINGS



Select "**Controller settings**" icon to open the menu that gives access to all controller settings pages.

Note: the number of menu/parameters displayed changes according to the configuration mode (standard/advanced).

CONTROLLER DYNAMIC SETTINGS

The "Dynamic" menu group gives access to the pages that contain all the parameters you need to set while engine is running.

Note: the number of menu/parameters displayed changes according to the configuration mode (standard/advanced).

CURVES

The PID settings pages provide curves display to help you during PID adjustment.

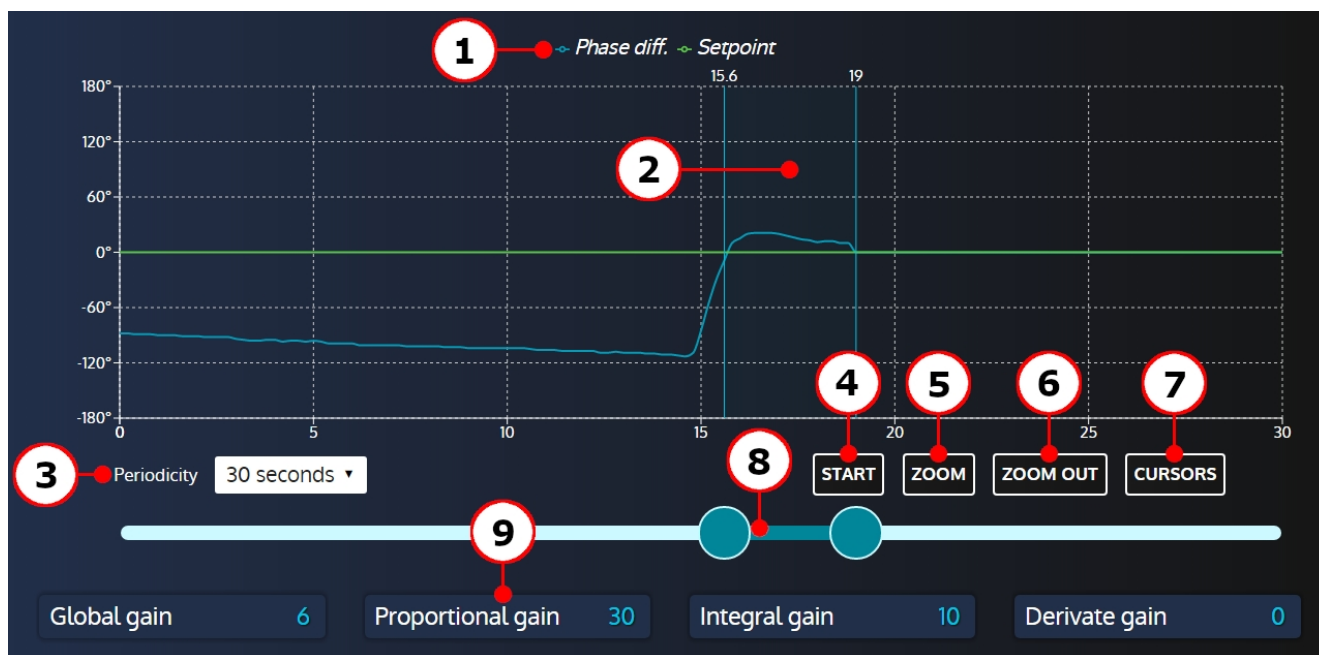

1. Curves legend.
2. Cursors zoom window.
3. Periodicity of the curve: 30 seconde, 1 minute or 2 minute.
4. Button to start/stop the curve recording.
5. Button to zoom in on the period between the two cursors.
6. Button to zoom out to the initial selected period.
7. Button to display/hide abscisse cursors.
8. Double slider to set the cursors window.
9. Parameters that affect the curve's measure.

PARAMETERS CONFIGURATION

The most of "**Controller Settings**" pages contains a list of parameters which are organized into different sections.

General	
Engine type	Diesel
Speed sensor type	Alternator
Number of poles pair	2
Number of teeth for pick-up	100
Oil pressure switch	Analog input 1
Coolant temperature switch	Analog input 2
Speed setpoint	1500 rpm
Speed setpoint (2)	1800 rpm
Idle speed	700 rpm

Content

SELECTABLE ITEMS	
	Parameter display. Select this area to open the editing window.
	Disabled parameter display (cannot be edited in this state). This parameter can be enabled by modifying another one on the same page.
	Read only variable display (supervision measure related to a parameter).
	Open an information pop-up related to the page/section.

EDITING WINDOWS

When a configuration variable is selected, an editing window opens to change the variable settings.

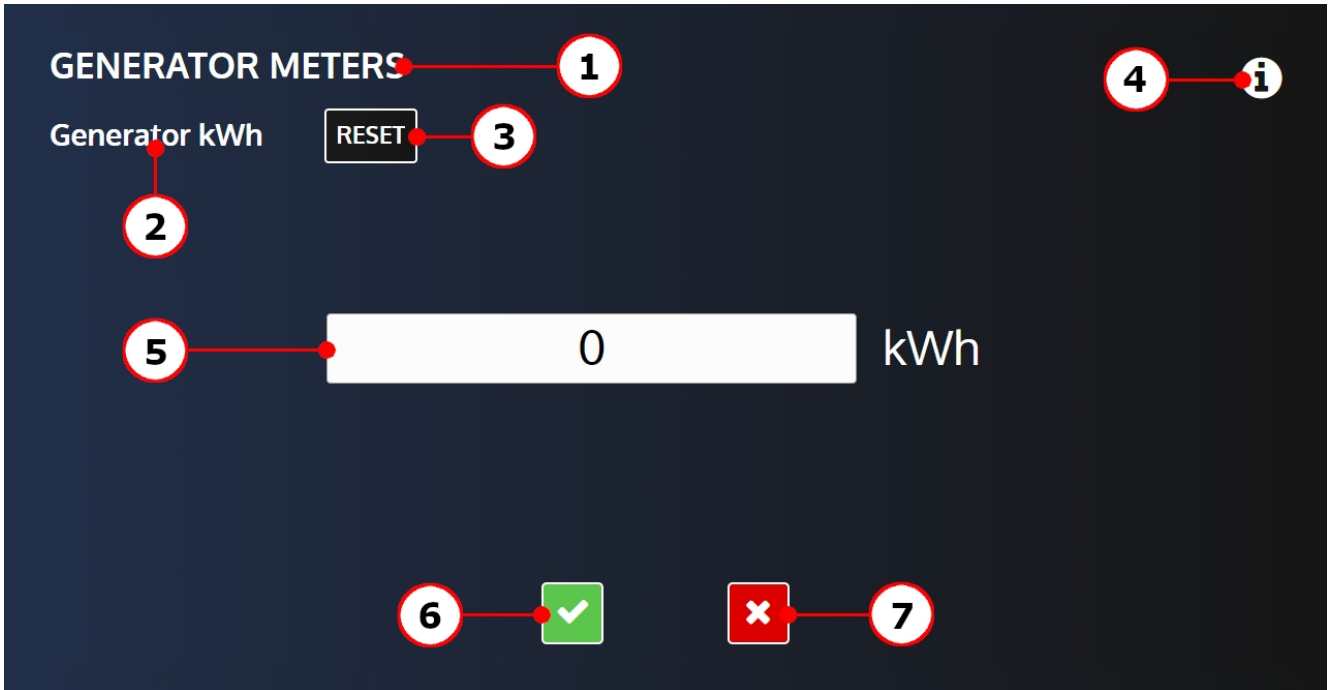

1. Title of the configuration section.
2. Label of the configuration variable.
3. Button linked to the configuration variable (optional).
4. Info button: Display the configuration variable number and a description of the variable.
5. Content: The content of the edit window vary depending on the type of variable.
6. Validation button:
 - Save your modification locally in Offline mode.
 - Send your modification to the controller in Online mode.
7. Cancel button: Cancel your modification.

NUMERIC

Input field to set the value of the parameter being edited. The unit of the parameter is displayed beside it.

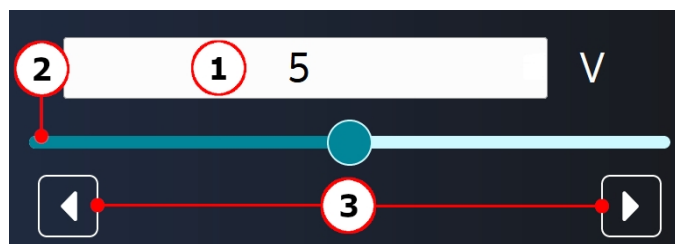

1. Current value and unit of the parameter being edited.
2. Configuration slider.
3. Increment/decrement arrows.

Selecting the input will open a numerical keyboard below it (if there isn't enough space to display the keyboard below, it will open on top):

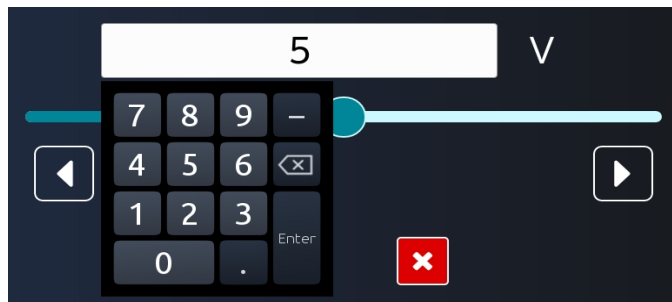

LIST

Some variables can be set through a drop-down list:



Select the list to open the drop-down menu and select an item to change the value.

DIGITAL INPUT

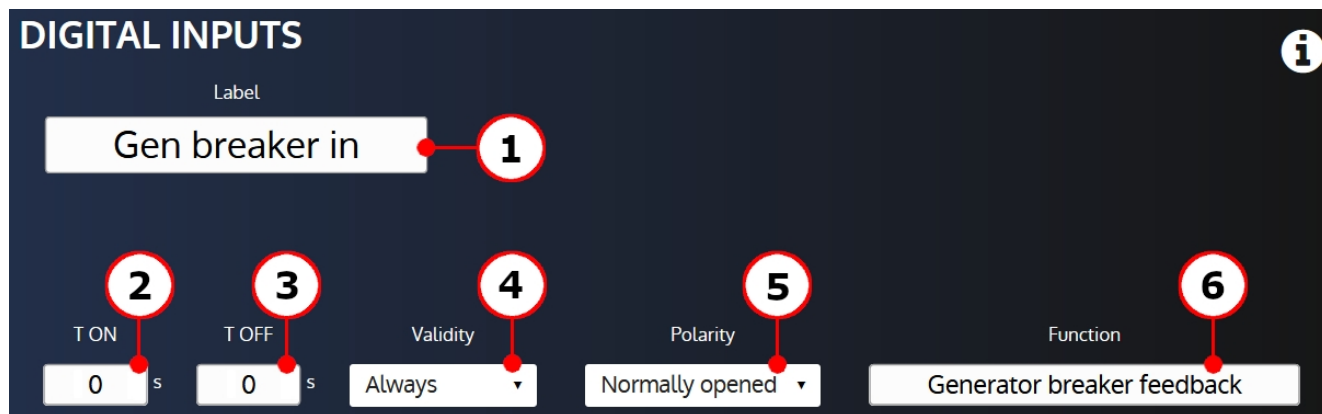

- The editing window of digital inputs allows you to configure:
1. Label: The digital input's label (limited to 14 characters).
 2. T ON: Delay before which the input becomes active.
 3. T OFF: Delay after which the input becomes inactive.
 4. Validity: Condition to take the digital input into account.
 5. Polarity: Digital input's polarity.
 6. Function: Digital input's function.

DIGITAL/RELAY OUTPUT

The editing window of digital/relay outputs allows you to configure:

1. Label: The digital/relay output's label (limited to 14 characters).
2. Polarity: Digital/relay output's polarity.
3. Function: Digital/relay output's function.
4. Pulse delay: Duration of the pulse high state. A pulse delay set to 0 correspond to a continuous activation.
5. Activation delay: Delay to wait before activating/deactivating the output.

TEXT

A text input is available to edit editable texts of the controller (limited to 21 characters):

PASSWORD

Two text inputs are available to edit a firmware password:

- Password: enter the new password in this input (limited to 8 characters).
- Confirm: enter the new password in this input in order to make a password verification (limited to 8 characters).

The "**Password**" and "**Confirm**" input content must be the same to validate the password change.

MODIFICATION BY VARIABLE NUMBER

The page titled "**Modification by variable number**" allows to search for a controller parameter through a search engine, and to change its value at your convenience:

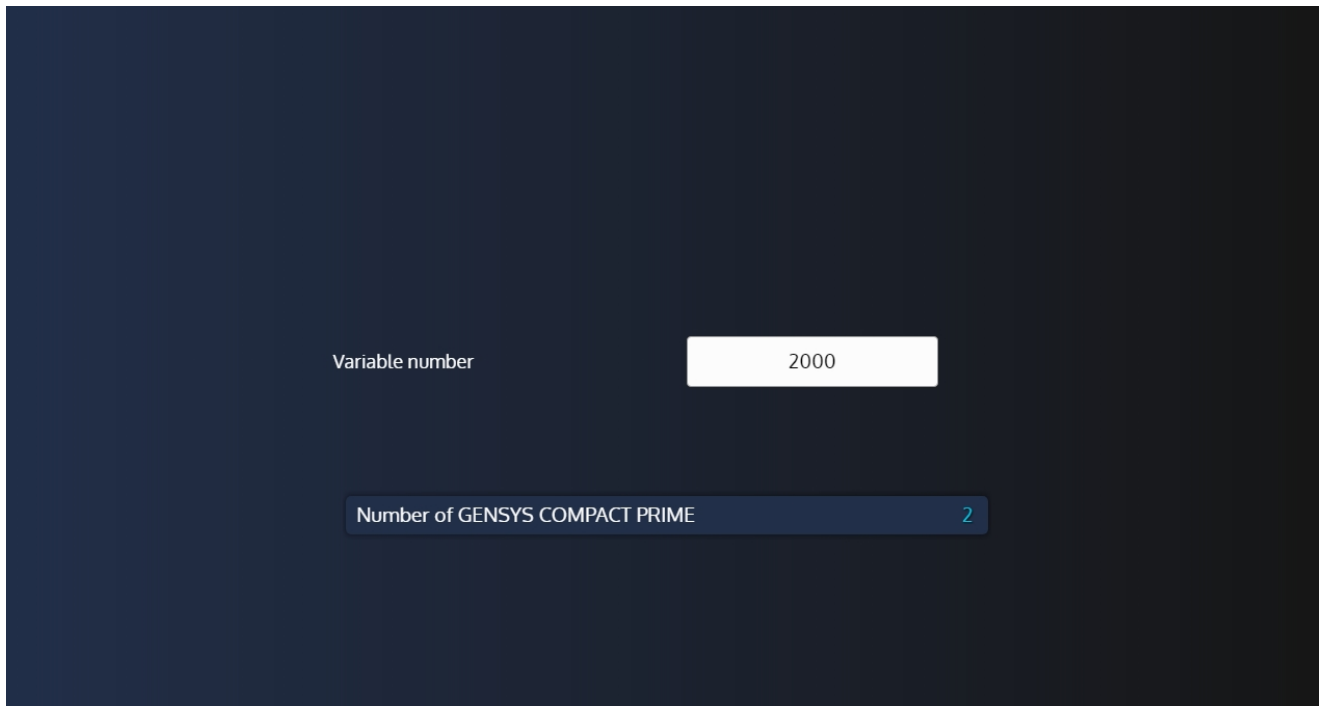

To change the value of a parameter:

1. Press the variable input field to open the search engine.
2. Search for the variable you want in the search engine.
3. Press the "+" button to select the variable you want to modify.
4. Press the parameter that has just been displayed to enter the editing mode.

Note: If the variable is not a parameter, it will still be displayed but greyed out and cannot be changed.

RESET FACTORY SETTINGS

Update controller firmware

The page System/Reset factory settings is available only in level 2 password.

This function allows you to reset controller configuration to factory settings:

1. Click on the "**Reset**" button.
2. If reset is successful, a success message is displayed.

UPDATE CONTROLLER FIRMWARE

Update controller firmware

The page System/Update allows you to update your controller firmware. Connect a USB key and then:

1. Click on the "**Update**" button to open the browser pop-up.
2. Browse and select the archive version you want to send to your controller.
3. Click on the browser "**Update**" button (and then press "**OK**" in the confirmation pop-up) to start the update.
4. Wait until all of update's steps are completed:
 - Updating firmware
 - Module initialization
 - Upload of language files
5. If the update is successful, a success message is displayed.

I4GEN SETTINGS



i4Gen" menu allows user to display and modify the **i4Gen** settings.
Press the touchscreen icon to open the menu that gives access to all **i4Gen** settings pages.

LANGUAGE

The "**Language**" menu allows you to change the application's textual language and the keyboard layout.

Display

The Display page allows you to modify the language of any text of the application:

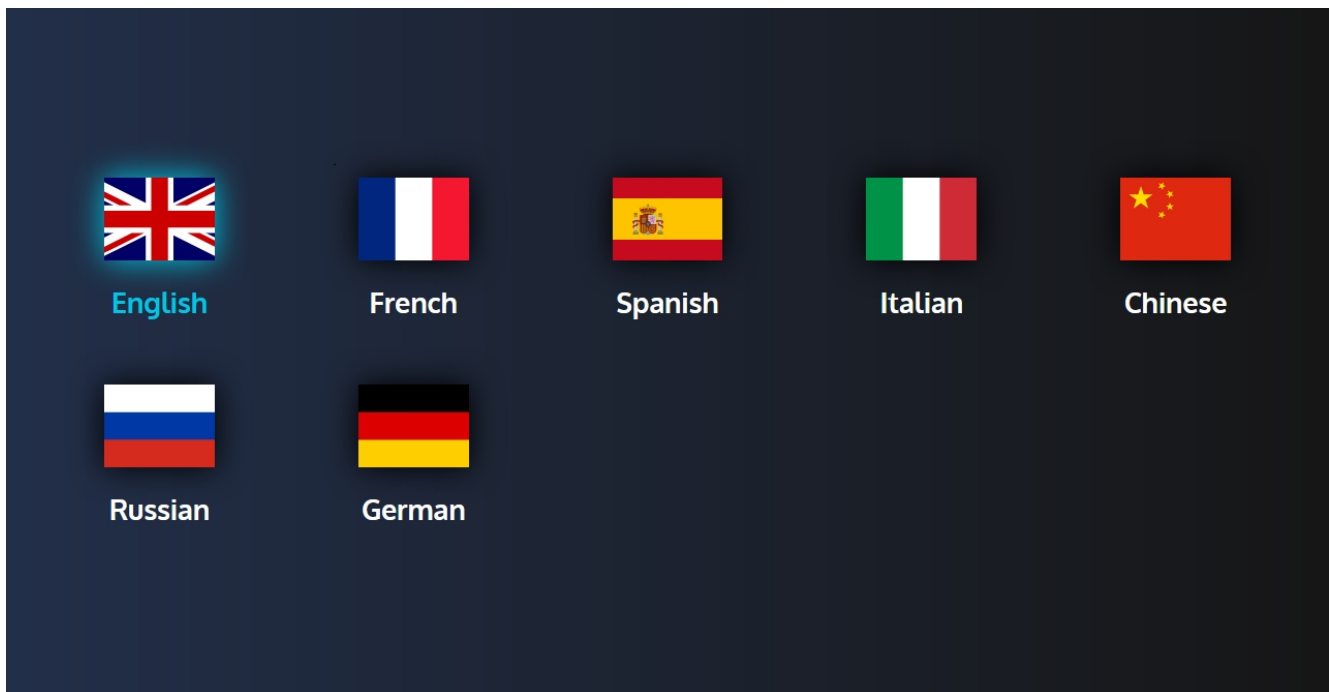

The available languages are:

- English
- French
- Spanish
- Italian
- Chinese
- Russian
- German

Keyboard

The Keyboard page allows you to switch the keyboard layout:



The available keyboard layout are:

- QWERTY (US)
- AZERTY (French)

SCREEN

The "**Screen**" page allows you to configure the **i4Gen** screen parameters:

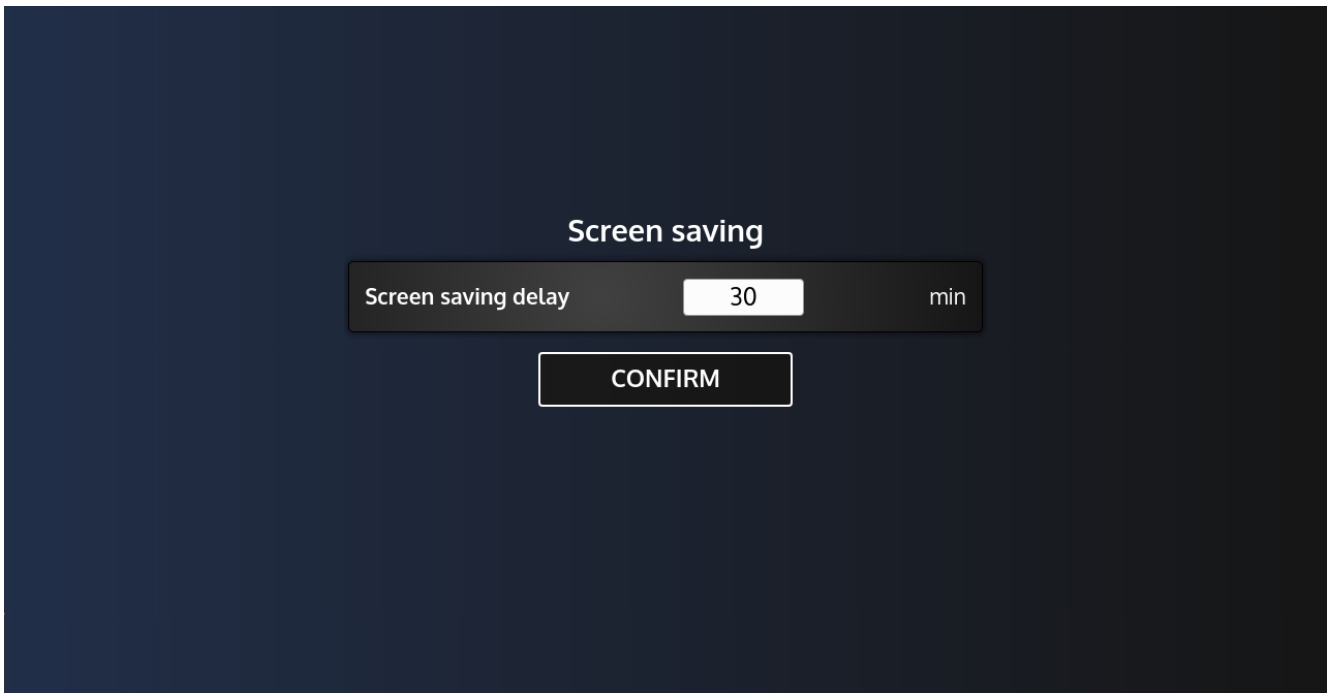

Screen Saver

The screen saver section is used to set the **i4Gen** screen saver.

- Screen saver delay: Allows you to configure the inactivity delay after which the screen saver appears.

CONNECTION

The "**Connection**" page allows you to configure the connection parameters of the **i4Gen**:

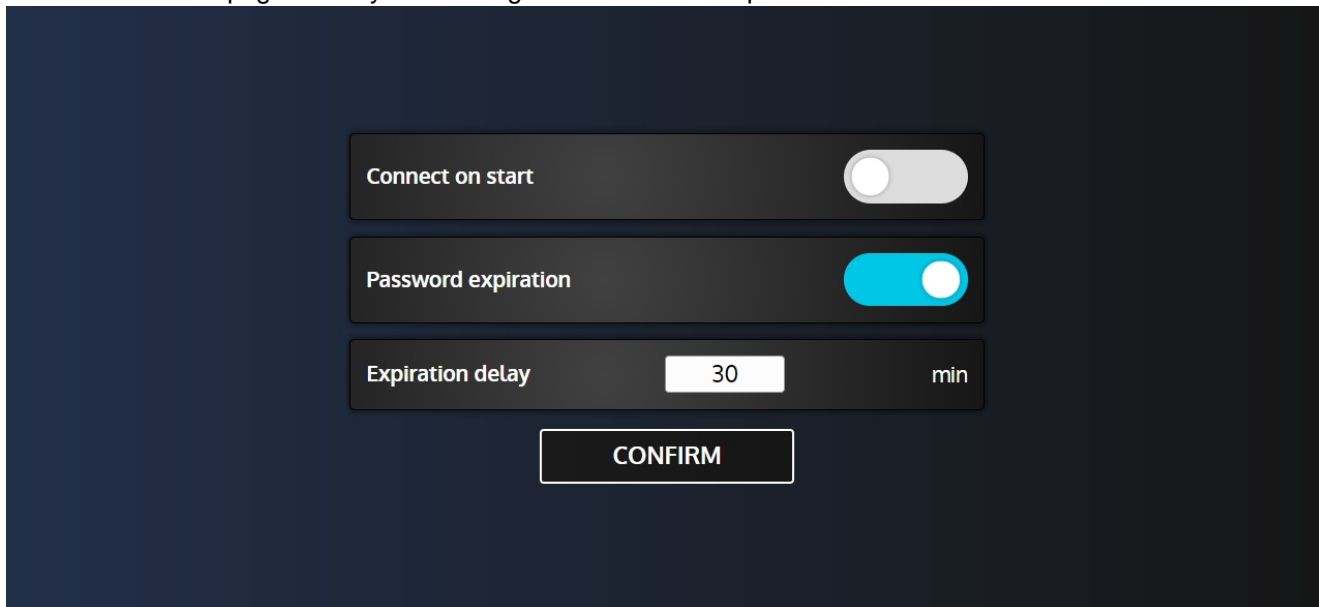

The screenshot shows a dark-themed configuration interface. It contains three rows of settings, each in a dark grey box. The first row has the label 'Connect on start' and a grey toggle switch. The second row has the label 'Password expiration' and a blue toggle switch. The third row has the label 'Expiration delay', a white input field containing the number '30', and the unit 'min' to its right. Below these settings is a white rectangular button with the text 'CONFIRM' in black.

Connect on Start

This parameter is used to activate/deactivate the automatic connection to a controller on **i4Gen** starting. By default, the **i4Gen** will attempt to connect to IP address 192.168.11.1. If the IP address has been modified and saved via the "**Preferences**" page, then the **i4Gen** will attempt to connect to that address.

Password Expiration

This parameter is used to enable/disable the password level expiration.

Expiration Delay

If the password expiration is enabled, this parameter is used to configure the delay after which the password will expire.

NETWORK

The "**Network**" menu retrieves and displays the **i4Gen** network configuration and allows you to modify it.

Ethernet IP settings / WIFI IP settings (only available in advanced mode)

These pages allow you to configure the ip settings of the network cards.

By default:

- The IP address of the Ethernet network card is 192.168.11.50 and the IP address of the controller is 192.168.11.1.
- The WIFI network card is set to DHCP.

There are two different types of configuration:

- **DHCP Configuration (automatic):** If the configured network is connected to a DHCP server, you can enable the "**DHCP**" setting to automatically assign an IP address to the device.
- **Manual Setup:** To manually configure the network settings, disable the "**DHCP**" setting, then fill in the "**IP address**" and "**Subnet Mask**" fields.

For most networks, it is not necessary to change the gateway and the DNS server settings. For complex networks, contact your network administrator to make the correct configuration.

Note:

- *Wifi IP settings can not be changed while **i4Gen** is connected to a Wifi network.*
- *The Ethernet card gateway has priority over the Wifi gateway. If the Ethernet card is used in a local network and you want to use the Wifi to give an internet access to i4Gen, please set the Ethernet IP settings gateway to 0.0.0.0.*

WIFI access point

This page allows you to connect your **i4Gen** to a wifi network.

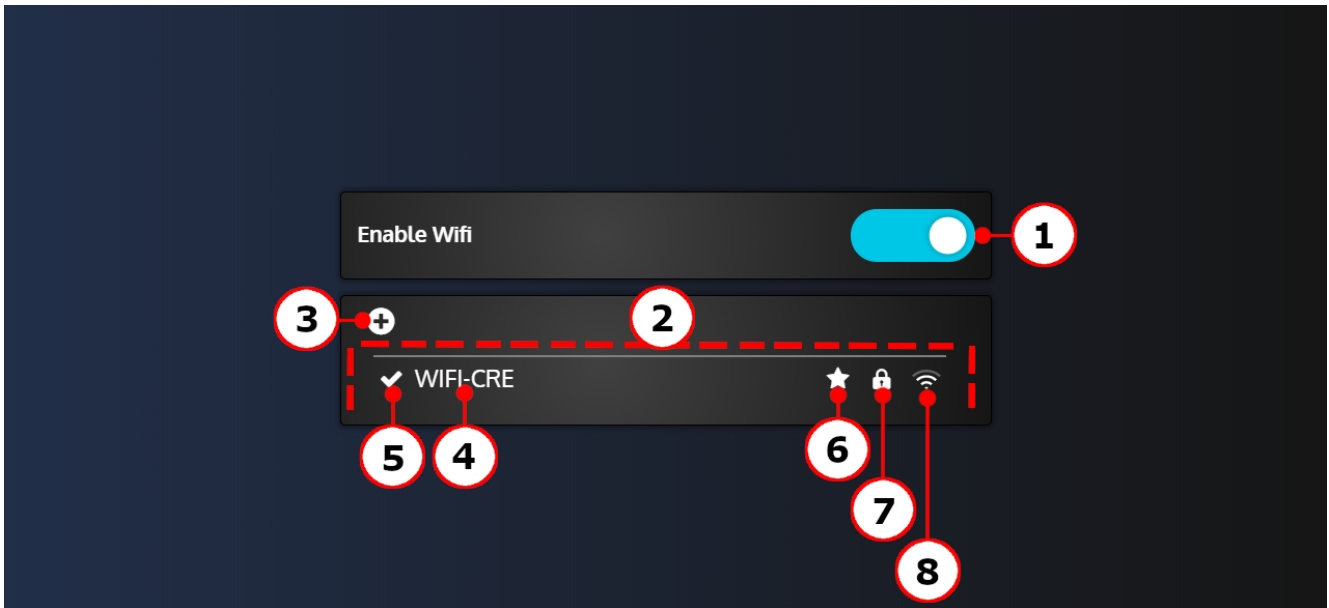

1. Used to enable/disable the WIFI.
2. List of available WIFI networks.
3. Used to add hidden WIFI networks using the **WIFI network management** window.
4. Display of an available WIFI network. Press on the network to open the **WIFI network management** window.
5. Means that you are currently connected to this network.
6. Means the network is saved.
7. Means the network is password protected.
8. Signal strength.

WIFI network management

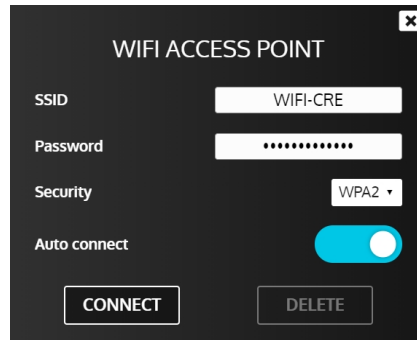

The screenshot shows a dark-themed dialog box titled "WIFI ACCESS POINT" with a close button (X) in the top right corner. It contains the following fields and controls:

- SSID:** A text input field containing "WIFI-CRE".
- Password:** A text input field with masked characters (dots).
- Security:** A dropdown menu currently set to "WPA2".
- Auto connect:** A toggle switch that is currently turned on (blue).
- Buttons:** Two buttons at the bottom: "CONNECT" and "DELETE".

- **SSID:** SSID of the WIFI network. Not editable for an existing network.
- **Password:** Password of the WIFI network.
- **Security:** Password encryption type.
- **Auto connect:** Enable this parameter to connect automatically to the network if it is available.
- **Connect:** Press this button to connect/disconnect to/from the WIFI network.
- **Delete:** Press this button to delete a saved network.

*Note: A WIFI network is automatically saved the first time you connect to it.
For WEP encrypted password, only 64-bit or 128-bit keys are supported. The password length is up to 10 hexadecimal characters for 64-bit keys and up to 26 hexadecimal characters for 128-bit keys.*

SERIAL PORT

The "**Serial port**" pages allow you to use **i4Gen** as a serial modbus gateway.

i4Gen can convert and route Modbus data between the serial lines and Ethernet RJ-45 connectors.

This can help to communicate between a Modbus RTU master device and the controller connected to **i4Gen** by Modbus/TCP.

i4Gen provides two RS232 serial port interfaces, a DE-9M connector (D-Sub male DB-9) and an RJ-45 COM port.

Once you are connected to the controller, **i4Gen** will open the communication between the serial ports and the controller.

Note: The DE-9M port is only available with i4Gen products that have been released in 2020 or later.

In the "**Serial port**" sub-menu, each page refers to a port configuration.

1. First you need to enable the corresponding port.
2. Then configure its Modbus RTU settings according to your Modbus master device.

Refer to the **Modicon Modbus Protocol Reference Guide** on www.modbus.org for more information about Modbus configuration.

3. Click on Confirm button to save your setting.
4. Connect your RS232 Modbus RTU device to **i4Gen**.
5. Connect **i4Gen** to the controller to launch the serial modbus gateway.

As long as you are connected, the gateway will automatically transmit all Modbus requests to the controller.

It is important to note that Rx signal is on the pin 2 of the connector and Tx on the pin 3. When wiring two devices together, make sure you're using a twisted cable (Rx pin from device 1 should end up in Tx pin of device 2 and Tx pin from device 1 should end up in Rx pin of device 2).

GND is on pin 5 and must always be wired.

FILE TRANSFER

The File transfer page allows you to save controller files on your USB flash drive and to load a configuration file to a controller.

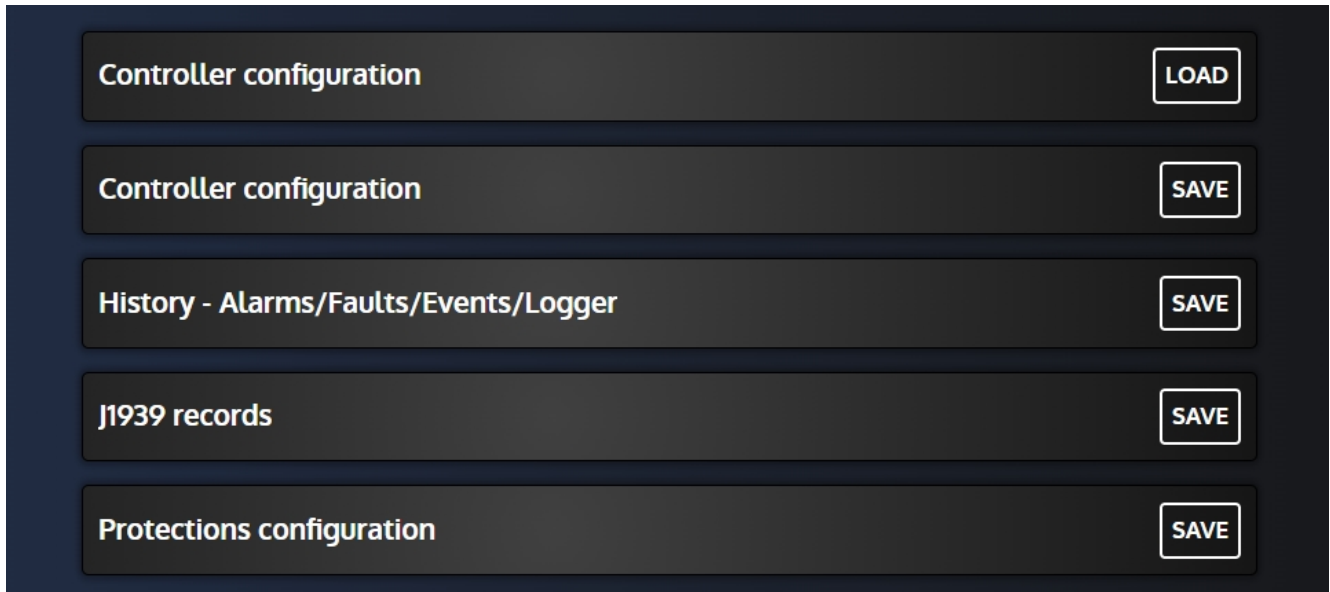

Saving a controller file on your USB flash drive

Connect a USB flash drive and then:

1. Click on the "**Save**" button to open the browser pop-up.
2. Select the folder in which you want to save the file.
3. Enter the name you want to attribute to your file in the "**File name**" input. If no name is entered, a default config file name is applied.
4. Click on the browser "**Save**" button to start the save.
5. If the save is successful, a success message is displayed.

Loading a configuration file to a controller (available only when a controller is connected)

Connect a USB flash drive containing a configuration file and then:

1. Click on the "**Load**" button to open the browser pop-up.
2. Browse and select the configuration file you want to load to the controller.
3. Click on the browser "**Load**" button to start the upload.
4. If the file has been successfully load, a success message is displayed.

REMOTE ACCESS

The "Remote access" page allows you to install/uninstall Zoho Assist to enable/disable a remote access to i4Gen.

How to create a Zoho Assist account

To create a Zoho Assist account, please go to <https://assist.zoho.com>

1. Enter your email address
2. Enter your password
3. Check the **I agree to the Terms of Service and Privacy Policy** checkbox
4. Click on **START MY FREE TRIAL**

A confirmation email will be send to your email address.

Once received, open the email and click on **Confirm your account**, then on the web page click on **VERIFY** to verify your email address.

You can now access your account clicking on **ACCESS YOUR ACCOUNT**. You have a trial period of 15 days. When the trial period is finished, you will have to make a subscription.

*Note: The remote access feature compatible with i4Gen is **Unattended Access**. Don't use the **Remote Support** feature.*

How to make a subscription



Click on the [BUY NOW](#) button to open the subscription form.

Subscription

1. Payment Cycle: Monthly Yearly (Get 2 months discount on yearly subscription) £ €

Plan	Units	Price
2. <input type="checkbox"/> Remote Support ⓘ <input type="radio"/> Standard ⓘ <input checked="" type="radio"/> Professional ⓘ <input type="radio"/> Enterprise ⓘ	Number of technicians: 1	€0
3. <input checked="" type="checkbox"/> Unattended Access ⓘ Standard	Number of devices (Unlimited technicians): 25	€10
Total		€10
Estimated amount to be paid per month*		€10

4. **UPGRADE**

*Additional taxes may apply.

1. Select the payment cycle you want (monthly or yearly). For a yearly subscription, you get a 2 months discount
2. Uncheck the **Remote Support** checkbox. This feature is not compatible with **i4Gen**
3. Check the **Unattended Access** checkbox and select the maximum number of devices on which you want to install Zoho Assist (from 25 to 3000)

- Click on the **UPGRADE** button to open the Billing & Address form and make the payment

How to deploy Zoho Assist on i4Gen

To deploy Zoho Assist on **i4Gen**, the unattended access installer (**Ubuntu/Debian 64 bits**) must be downloaded from the Zoho Assist website.

Please refer to the section **To download the unattended access installer in Zoho Assist** of the Zoho Assist user guide [Unattended Access Installation for Linux](#) chapter.

Once the unattended access installer has been downloaded, please follow the next steps:

- Put the Zoho Assist Installer on a USB stick
- Plug the USB stick on your **i4Gen**
- Open the **Remote Access** page
- If Zoho Assist is not installed on the device, a **INSTALL** button will be available. Click on this button to open a file browser
- Connect the device to Internet

⚠ WARNING

The device need to be connected to Internet while doing the installation, otherwise the device won't be detected by your Zoho Assist Account.

Do not remove the USB stick during the installation to avoid disrupting file transfer.

- Select the Zoho Assist installer (.deb) file and click on the **INSTALL** button.
- If Zoho Assist is successfully installed, a success popup should be displayed.

Note: If Zoho Assist was installed without being connected to Internet, the device won't be detected by your Zoho Assist Account. In that case, uninstall Zoho Assist and reinstall it being connected to Internet.

How to uninstall Zoho Assist from i4Gen

If you don't want to use the remote access feature anymore, you can uninstall Zoho Assist from your device:

- If Zoho Assist is installed on the device, a **UNINSTALL** button will be available. Click on this button to open a confirmation window
- Click on the **YES** button to confirm the uninstall of Zoho Assist
- If the uninstall is successful, a success popup is displayed
- In the devices list of your Zoho Assist account, you can delete the device from the list.

How to manage devices

To manage the devices list, please refer to the Zoho Assist user guide [Manage Devices](#) chapter.

*Note: the unattended access installer can't be installed/uninstalled to/from **i4Gen** using Zoho Assist website. It must be done using a USB stick.*

How to start a Zoho Assist Unattended Access session

Once Zoho Assist has been successfully installed on your **i4Gen**, an Unattended Access session can be started from your Zoho Assist account.

Please refer to the Zoho Assist user guide [Access Devices](#) chapter.

Unattended Access session can be started from Zoho Assist **web site**, **desktop** application, **iOS** application, **Android** application.

During an Unattended session, the following features are compatible with i4Gen:

- View features
- Session features
- Tools (Power options):
 - Reboot
 - Shutdown

*Note: While accessing an **i4Gen** remotely, please do not change its keyboard layout. If you do so, it may cause character mismatches between what you type on your PC keyboard and what the **i4Gen** will display. If the **i4Gen's** keyboard layout got changed during a Zoho Assist session, restart **i4Gen** via the Settings -> System -> Restart button and close your Zoho Assist session. You can resume the session once **i4Gen** booted and is back online.*

How to create users/groups

On your Zoho Assist Account, you can create users and groups and configure their permissions to give them access (or not) to your devices.

You can create as many users/groups as you want.

One user/group can access several devices.

For more information about creating users and groups, please refer to Zoho Assist documentation:

<https://www.zoho.com/assist/help/grouping-computers.html>

DATE/TIME SYNCHRONISATION

Enabling the "Automatically synchronize the date/time from the network" parameter allows **i4Gen** to automatically get the date and time from a time server through NTP. You can set the UTC timezone to display the time with the offset that you want.

Please note that an internet connection is mandatory for this feature to work.

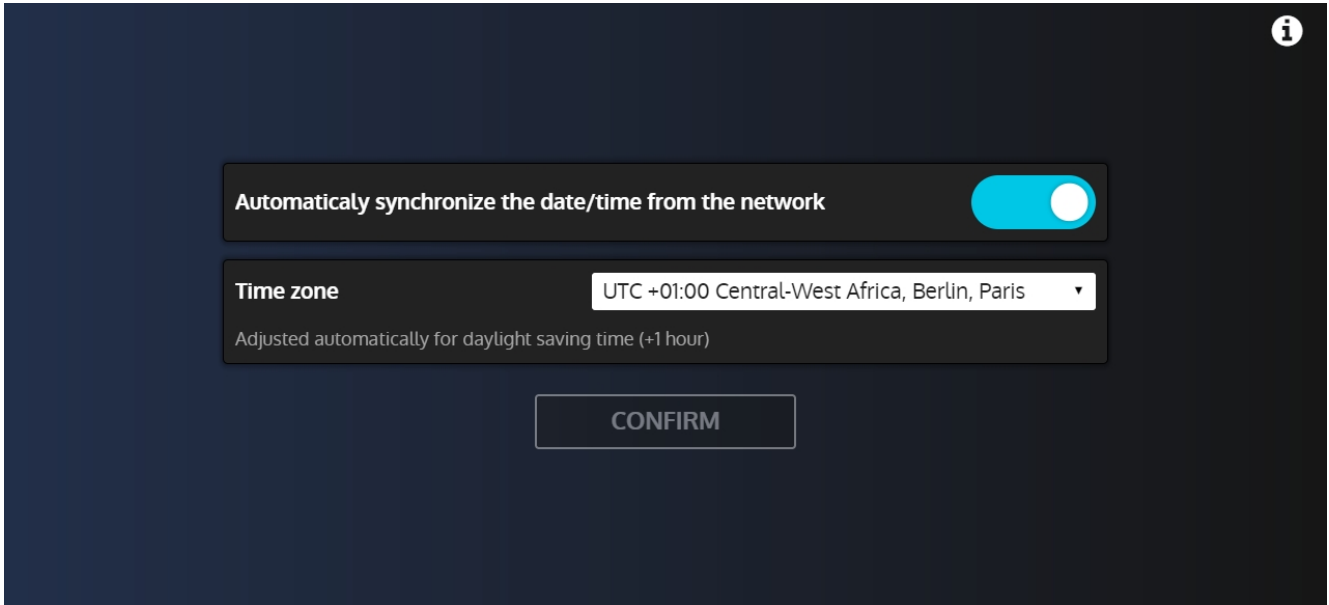

When connected to a controller with this feature enabled, **i4Gen** will continuously set the controller date and time; thus it is not possible to modify it manually in the menu **Controller settings/System/Date/Time**.

This feature is required for the email notifications to work properly; thus it will be enforced if email notifications are enable.

EMAILS

Once connected to a controller, **i4Gen** can send email notifications when an event happens. Events happening while **i4Gen** is not connected/attempting to reconnect or during a loss of Internet connection are not taken into account.

This functionality requires a controller version 2.12 or above. This page will be hidden if connecting to a controller with a lower version and **i4Gen** will not be able to send any email notifications.

Enabling this feature will automatically turn on the "Automatic date/time synchronisation from the network" feature since it is required to work (don't forget to set your UTC timezone). See [Date/time synchronisation](#). Please note that an Internet connection is mandatory for the functionality to work.

The maximum amount of recipients for a single event is limited to 5. **i4Gen** can't send events faster than once every 10 minutes. When an event occurs, if nothing has been sent during the last 10 minutes, an email will be sent instantly. After that, for a 10 minutes period, every event occurring during this time frame will be saved and sent all at once after 10 minutes. The cycle repeats until there is no events left to send. If nothing happened during the 10 minutes period following the sending of an email, the next one will be sent instantly.

CRE TECHNOLOGY recommends adding the email address **do_not_reply@i4gen.com** to your email client whitelist as **i4Gen** emails may be seen as spam because of its content.

The "**Emails**" page allow to change settings for email sendings:

Enable email sending

Enable/disable email notifications. **i4Gen** will then be able to send them once connected to a controller.

Event type

Define which type of event will trigger an email notification.

The currently supported events are:

- Alarms
- Faults
- Events

It is possible to mix up event types to send as you wish using the checkboxes inside the list.

Trigger on

Once the type of events are defined, it is possible to choose if it will trigger on activation only or on both activation and deactivation.

Mailing list

The "**Manage**" button allows to edit the list of recipients for email notifications:

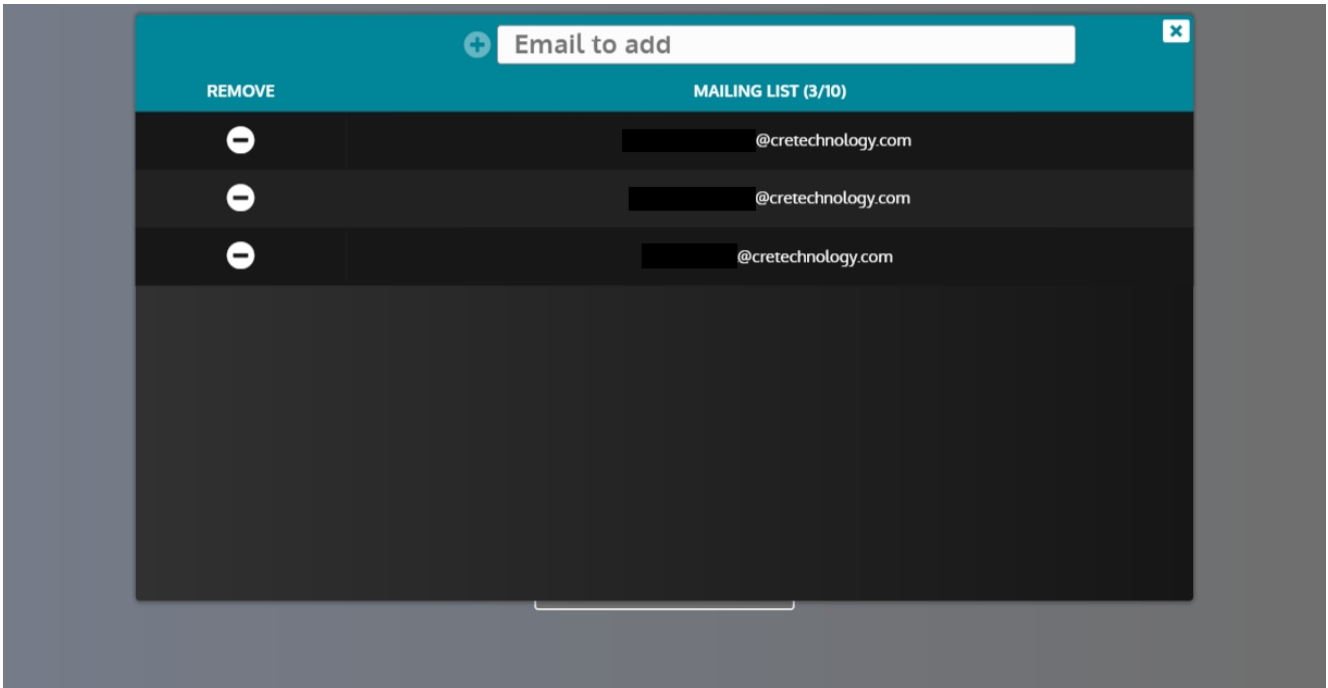

Using the + button you can add a new email address to the list.
Note that this address should be compliant to the RFC 3696.

The - button allows you to remove an address from the list.

Sender name

Define the name of the email sender (set to **i4Gen** by default).

Show email error notifications

To display a popup message when an email fails to send.

Send test email

Clicking the "**Send**" button will send a generic test email to the current mailing list allowing you to check that you're properly receiving emails from your **i4Gen**.

Email content

The email sent on event trigger contains the following information:

- Content: May contain one or multiple events with detailed informations
- Attachment: CSV file containing the alarms/faults/events history of the controller

Note that a maximum of 30 events can be reported in a single email.

To open the CSV file with Excel in a proper format, follow this steps:

1. Open a new Excel sheet.
2. Select the **Data** tab.
3. Select **From Text** in the **Get external Data** section.
4. Navigate to the CSV file you wish to open and click **Import**.
5. From the newly-opened window, choose **Delimited** and **File origin: 65001: Unicode (UTF-8)**. Then click **Next**.
6. Check the **Semicolon** box in the **Delimiters** settings. Then click **Next**.
7. Click **Finish**.

PRODUCTION CURVES

The **i4Gen** can record the power produced by your installation and display it in a graph. This functionality requires to be connected to a controller to be able to access and save datas.

The **i4Gen** can then display the total active and reactive power produced over time in a graph.

The following controllers are compatible with this feature:

- GENSYS COMPACT PRIME
- MASTER COMPACT/MASTER COMPACT 1B
- PV COMPACT
- BAT COMPACT

SETTINGS

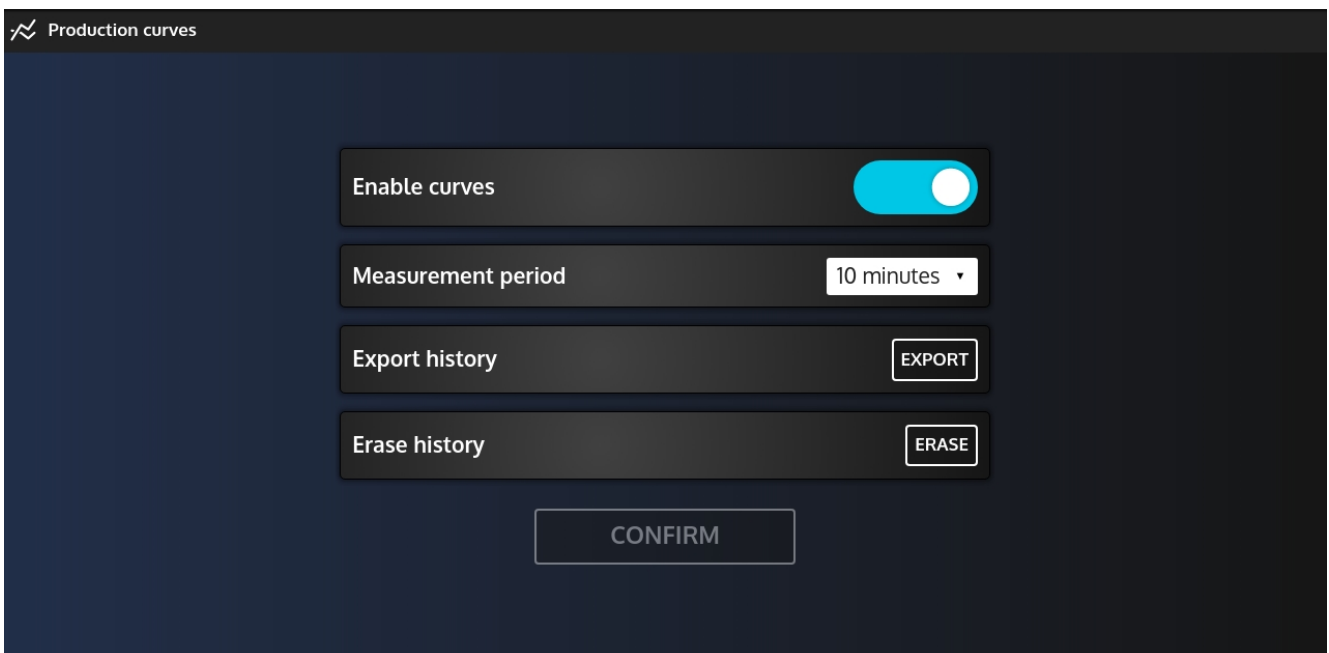

- **Enable curves:** Enable or disable this feature.
- **Measurement period:** Delay between each recording from the **i4Gen**.
- **Export history:** Export the production curves history on a USB key. The exported file will be a zip file containing all the saved datas from the **i4Gen** as csv files (each csv file contains 1 year of data and will be named accordingly i.e "ProductionCurves-2021-2022.csv").
The **i4Gen** can save up to 30 years of data before rotating files so you don't have to worry about having to export the history frequently.
- **Erase history:** Permanently delete all saved production curve data from the **i4Gen**. It is widely recommended to export saved datas before you do so.

WARNING



The **i4Gen** will only record data as long as it is connected to a compatible controller. No specific user level is required so you can simply login as a level 0 user. The **i4Gen** will record as long as it is connected even if the password expiration triggers.

RESTART

This page allows you to restart **i4Gen**.

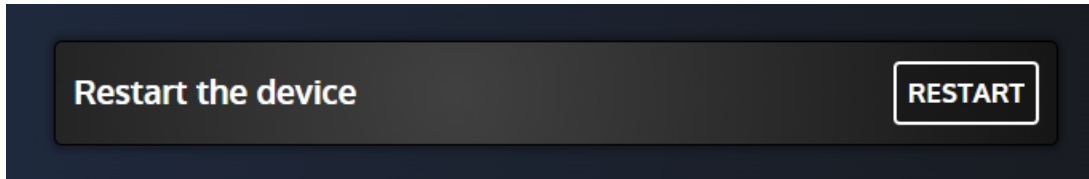

Press the restart button to reboot the device.

UPDATE

This page allows you to update the **i4Gen** application version.

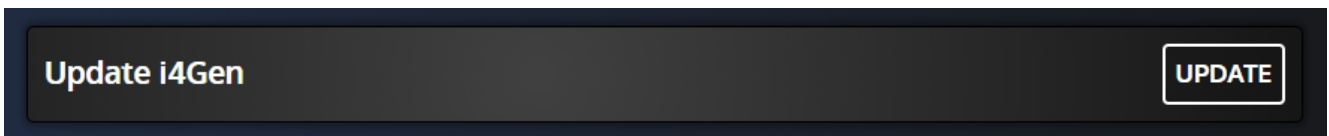

Update procedure

1. Connect a USB key containing the **i4Gen** update archive. Then press "**Update application**" button to open a browser pop-up:

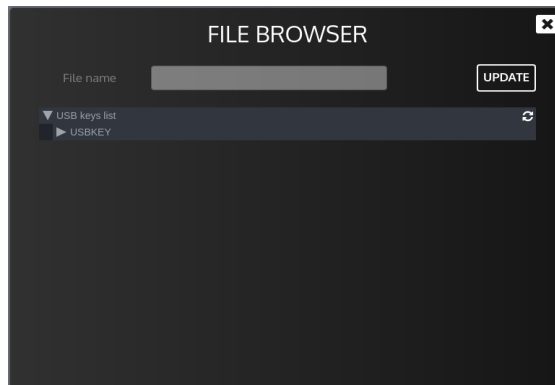

2. Browse on your USB stick via the folder tree and select the update archive. You can press the  button to refresh the **i4Gen** USB device display.
3. Press the "**Update Application**" button to check the contents of the archive. A confirmation window should appear on the screen, press "**Confirm**" to start the update.
4. Once the update is done, the **i4Gen** restarts automatically.

WARNING

Do not remove the USB key during the update to avoid disrupting file transfer.

DIMENSIONS

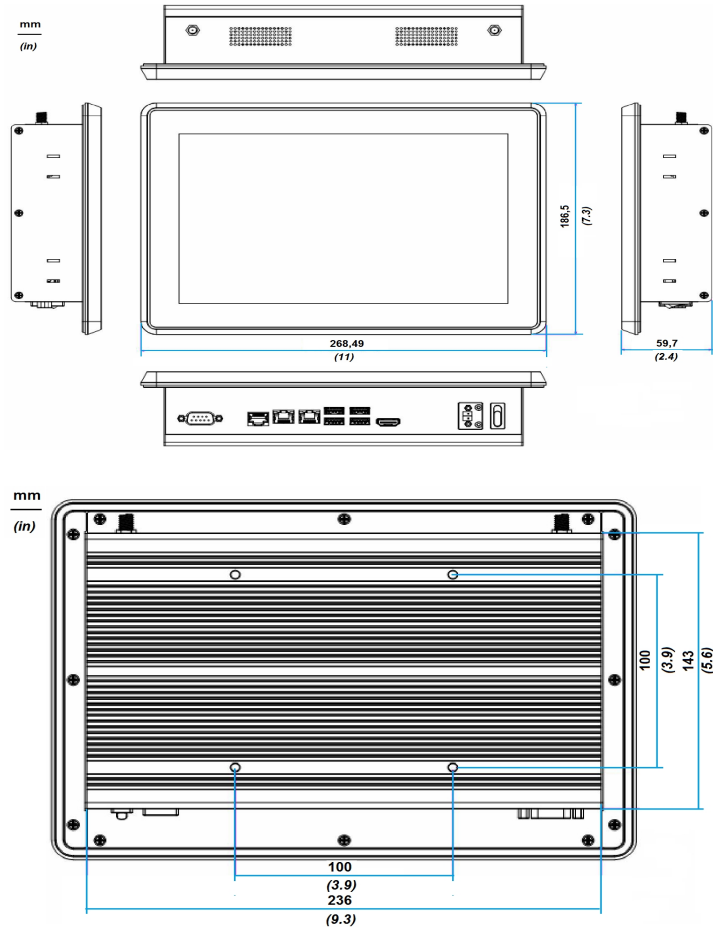

Note: Measure unit: mm (in)