



EASY PLC

Technical Documentation



*“Graphical logic editor for GENSYS 2.0
and MASTER 2.0 family”*

Part Number:
A70 Z2 9 0020-D-En

CRE TECHNOLOGY



130, Allée Victor Naudin
Zone des Templier
Sophia-Antipolis
06410 Biot
FRANCE



Phone: +33 (0)4 92 38 86 82

Fax: +33 (0)4 92 38 86 83

Website: www.cretechnology.com



Email: info@cretechnology.com

NOTE



Read this entire manual and all other publications pertaining to the work to be performed before installing, operating, or servicing this equipment. Apply all plant and safety instructions and precautions. Failure to follow instructions can cause personal injury and/or property damage.

Motors, turbines and any other type of generator must be equipped with protections (overspeed, high temperature, low pressure...) depending on the power plant.

Any changes of the normal use of the equipment can cause human and material damage.

For further information, please contact your CRE Technology distributor or the After-Sales Service Team.

All CRE Technology products are delivered with one year warranty, and if necessary we will be happy to come on site for product commissioning or troubleshooting. The company also provide specific trainings on our products and softwares.



Technical support: +33 (0)4 92 38 86 86 (office hours: 8.30AM-12AM / 2PM-6PM GMT+1).
Email: support@cretechnology.com



SKYPE: support-cretechnology.com



INFORMATION

You can download the most up-to-date version of this documentation and different other documentations relating to CRE Technology products on our Web site <http://www.cretechnology.com>.

CRE Technology believes that all information provided herein is correct and reliable and reserves the right to update at any time. CRE Technology does not assume any responsibility for its use.

Technical documentation history

Date	Version	Comments
March 2012	A	Initial revision.
August 2013	B	Updates for version 1.02: <ul style="list-style-type: none"> List of input/output variables updated according to GENSYS 2.0 v4.55a2. Java 7 compatibility. Directly send compiled equations to a GENSYS 2.0/MASTER2.0 module. Logical bitwise functions. New multiplexer with variable size. Zoom in/out using the mouse. Inputs/Outputs blocks can be modified using double click.
March 2014	C	Updates for version 1.04 : <ul style="list-style-type: none"> List of input/output variables updated according to GENSYS 2.0 v4.66. Comparison functions. Logical flip-flop (RS/D) functions. Positioning grid for blocs added. Management of equations level 1 and 2. Predefined functions library added. Logical inputs/outputs are automatically set to “used by equations” Automatically allow variables in write. Text files are now integrated into Easy PLC’s projects.
October 2015	D	Updates for version 1.04c: <ul style="list-style-type: none"> New predefined functions available.

Documentations available on CRE Technology Web site:

- A53 Z0 9 0020 – GENSYS 2.0 technical documentation.
- A53 Z0 9 0030 – GENSYS 2.0 variables (measurements, parameters, internal variables).
- A54 Z0 9 0020 – MASTER 2.0 technical documentation.

1 TABLE OF CONTENTS

1	Table of contents	4
2	List of figures	5
3	List of tables	6
4	Overview	7
5	Installation	8
5.1	System requirements.....	8
5.2	Software installation	8
5.3	Software installation troubles	9
6	Description	10
6.1	Main window.....	10
6.2	Equation sheet.....	11
6.3	Main menu and toolbar	11
6.3.1	Main menu.....	12
6.3.2	Toolbar description	14
7	Creating a project	16
7.1	Creating a new project.....	16
7.2	Managing files	16
7.2.1	Adding a file	16
7.2.2	Renaming equation sheets	17
7.2.3	Sorting files	17
7.2.4	Removing files.....	18
7.3	Equation execution condition.....	18
7.3.1	If.../Else condition.....	19
7.4	Designing an equation	20
7.4.1	Equation inputs.....	21
7.4.2	Equation outputs.....	22
7.4.3	Equation operators.....	24
7.4.4	Managing block connections	37
7.4.5	Predefined functions library	38
7.5	Text files	42
8	Compiling a project	44
8.1	Further information.....	45
9	Sending compiled equations	46
10	CRE Technology	48

2 LIST OF FIGURES

Figure 1: Installing with administrator privileges	9
Figure 2: Easy PLC main window.....	10
Figure 3: Equation sheet components.....	11
Figure 4: Menu and toolbar.....	12
Figure 5: Setting the equation level	16
Figure 6: Project properties.....	16
Figure 7: Adding an equation sheet	17
Figure 8: Renaming an equation sheet.....	17
Figure 9: Sorting equation sheets	18
Figure 10: Removing equation sheets	18
Figure 11: If/Else condition.....	20
Figure 12: Input selection	21
Figure 13: Input filtering.....	21
Figure 14: Output selection	23
Figure 15: Parameter used as an output.....	23
Figure 16: NAND block with 4 inputs.....	25
Figure 17: Filling internal variables of an operator.....	26
Figure 18: Block must be connected to an output.....	26
Figure 19: Multiply operator with 5 inputs.....	27
Figure 20: Connection to an INC operator.....	27
Figure 21: Modifying the number of inputs of a multiplexer	29
Figure 22: Block must be connected to an output.....	30
Figure 23: Filter block internal variables	30
Figure 24: Timer operator chronogram.....	31
Figure 25: Filter example.....	31
Figure 26: Setting the bit number.....	33
Figure 27: Configuration of a mask operator	34
Figure 28: Setting a bit shift	34
Figure 29: Configuration of a setbit operator.....	35
Figure 30: Chronogram of a delay comparator	36
Figure 31: Filling the internal variables of an operator	37
Figure 32: Creating a block connection	37
Figure 33: Connection with additional corners.....	38
Figure 34: Predefined functions library	38
Figure 35: Add a predefined function to your project	39
Figure 36: Add a function to the library	39
Figure 37: Main equation sheet.....	43
Figure 38: Compilation button.....	44
Figure 39: Compilation error	44
Figure 40: Project successfully compiled	44
Figure 41: Send file button	46
Figure 42: Configuration window.....	46
Figure 43: Connection	47
Figure 44: Sending	47
Figure 45: Successful Sending	47
Figure 46: Access to CRE Technology	48
Figure 47: CRE Technology distributors.....	49

3 LIST OF TABLES

<i>Table 1: File menu</i>	12
<i>Table 2: Edit menu</i>	13
<i>Table 3: Tools menu</i>	14
<i>Table 4: Help menu</i>	14
<i>Table 5: Toolbar commands</i>	15
<i>Table 6: Logic operators</i>	25
<i>Table 7: Arithmetic operators</i>	27
<i>Table 8: Comparison operators</i>	28
<i>Table 9: Special functions operators</i>	29
<i>Table 10: Bit access operators</i>	33
<i>Table 11: Comparators</i>	36
<i>Table 12: Connections possibilities</i>	38
<i>Table 13: Starting gas sequence</i>	41
<i>Table 14: Custom crank selection sequence</i>	42

4 OVERVIEW

Easy PLC is a software developed by CRE Technology to graphically create logic equations for the GENSYS 2.0/MASTER 2.0 product family (*). This way you can customize your product, create your own automatic sequences and adapt your module to the very specific needs of your application.

Easy PLC helps you design your equation without any knowledge of CRE Technology proprietary programming language.

Easy PLC software should be used with GENSYS 2.0 technical documentations to fully understand GENSYS 2.0 internal use of parameters and variables.

(*) Except GENSYS 2.0 LT modules which doesn't handle custom equations.

5 INSTALLATION

5.1 SYSTEM REQUIREMENTS

- **Supported Operating Systems:** Windows 8 or above, Windows 7, Windows Vista, Windows XP, Linux Ubuntu 11.10, Windows Server 2003, Windows Server 2008.
- **Java 2 Platform**, Standard Edition. Version 1.6 (Minimum), Version 1.7 or above (Recommended). Also compatible with *OpenJDK Runtime Environment (IcedTea6)*.
- **Processor:** 400 MHz Pentium processor or equivalent (Minimum); 1GHz Pentium processor or equivalent (Recommended)
- **RAM:** 128 MB (Minimum); 256 MB (Recommended)
- **Hard Disk:** Up to 500 MB of available space may be required.
- **Display:** 1024 x 768, 256 colours (Minimum).

5.2 SOFTWARE INSTALLATION

Easy PLC runs in a Java environment. Users must make sure that Java Runtime Environment 7 or above is installed on their computer. If Java is not installed on your computer, you can download it from <http://www.java.com> Web site.

If you're about to install **Easy PLC** V1.04 or above, you can skip the rest of this chapter. You just need to run **SetupEasyPLC.exe**.

For **Easy PLC** version prior 1.04, double click on **SetupEasyPLC.jar** and follow the instructions. You may get the message shown below. In this case, simply select "**Yes**".

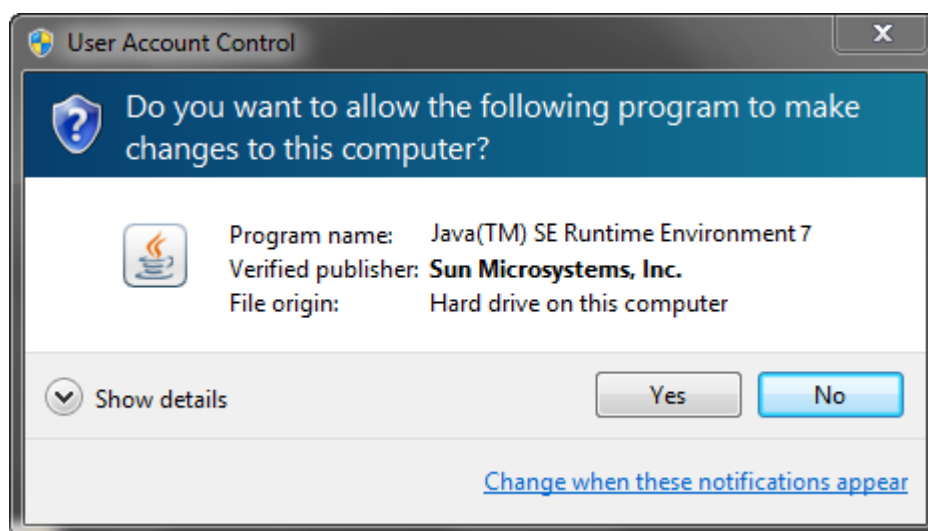

When installation is complete, you can launch **Easy PLC** using the links created in Windows menu or on your desktop.

5.3 SOFTWARE INSTALLATION TROUBLES

Under Windows Vista/7, you may need to right click on the **SetupEasyPLC** icon and select “Run as administrator” as shown below to install the software.

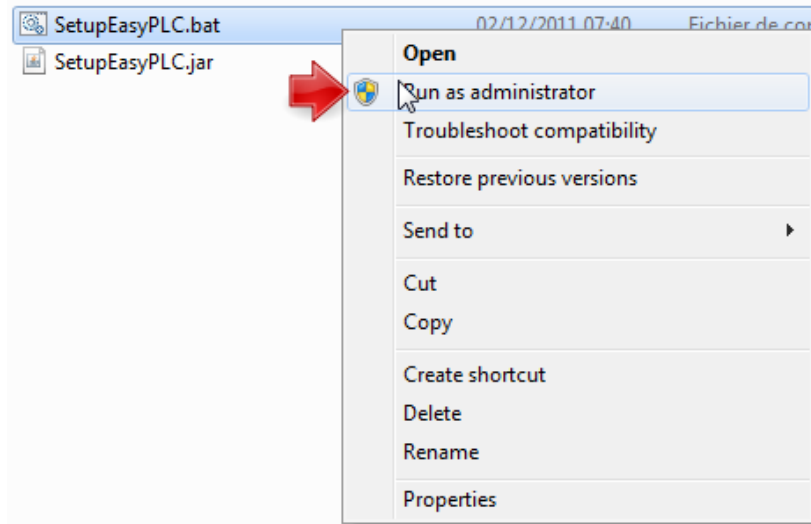

FIGURE 1: INSTALLING WITH ADMINISTRATOR PRIVILEGES

On some computers, JAR files cannot be launched directly (using double click). This is a Windows/Java compatibility problem that can be solved by using “.BAT” files instead of the “.JAR” files.

6 DESCRIPTION

6.1 MAIN WINDOW

The main window is displayed when you start **Easy PLC** software. A blank new project is automatically opened with a single equation sheet called *Default.cre* (only for version 1.02 and below). “CRE” is the file extension used to designate graphical equation sheets used under Easy PLC. Picture below shows this main window with the *TempProject* sheet opened. Each main section of the window is shown on the picture:

- Project tree: this is where you can manage (add/delete/rename) the files of the project.
- Equation sheet: this is where you will design your equations, enter optional comments and decide when this equation should be executed.
- List of operators: this is where you can select the operators you will use in your equations.
- Input/output section: this is where you will select the list of variables you want to see (input or output variables) and then see the corresponding list of existing variables so you can use them in your equations.
- Compilation section: this is where you will see if your project was successfully compiled or if errors were encountered during compilation process.

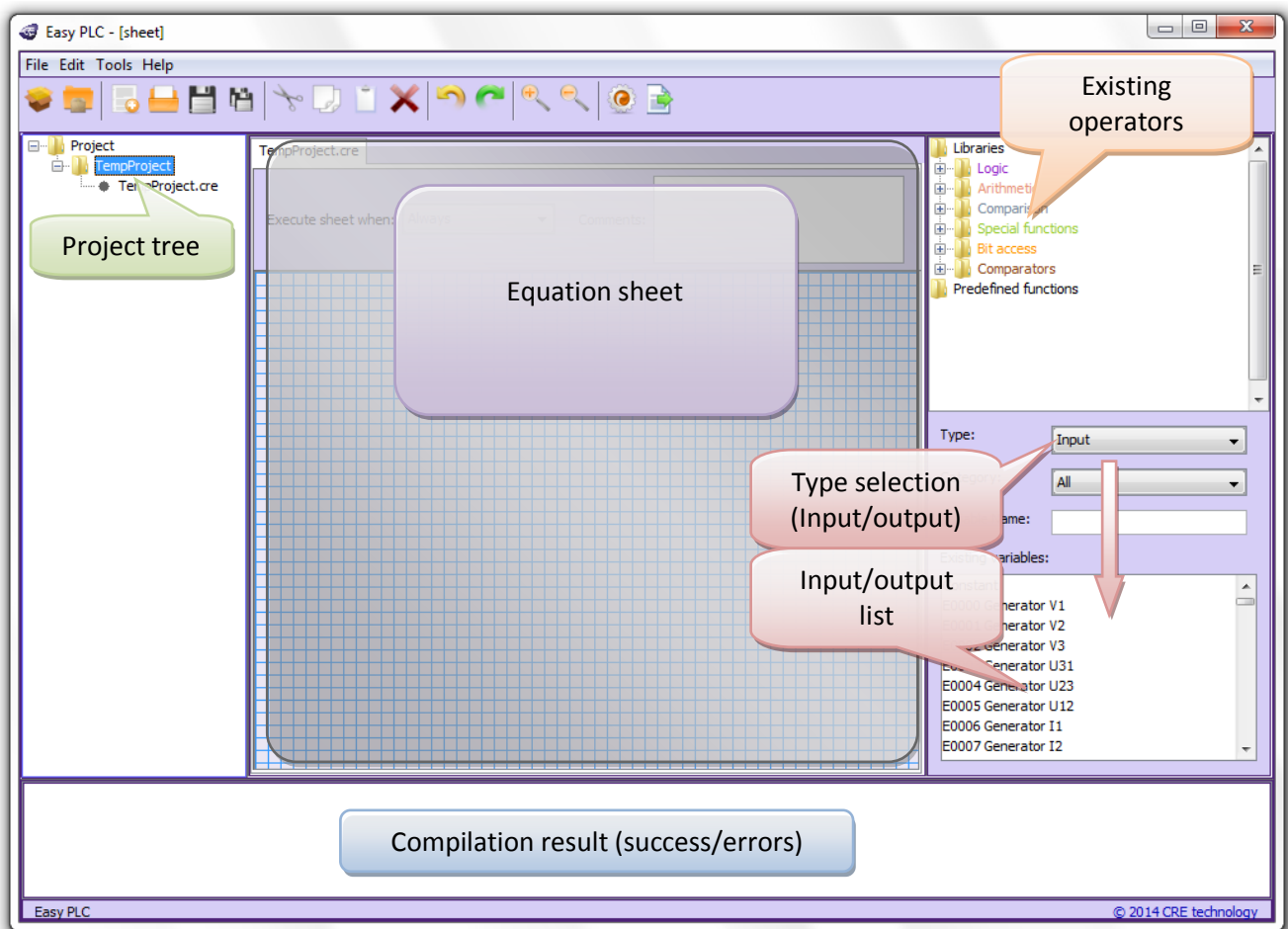

FIGURE 2: EASY PLC MAIN WINDOW

6.2 EQUATION SHEET

Picture below gives you more details concerning the equation sheet section of **Easy PLC** main window. Two small equations have been designed in this equation sheet to show you the different components you may use:

- Execution condition: here you can decide when equations drawn on the sheet should be executed. See specific chapter 7.3 for more details.
- Comments: here you can enter a small text to explain what the goal of your equations is.
- Equations: they are made of inputs (variables or constant values) combined with operators to make a specific test or calculation stored into an output. See specific chapter 7.4 for more details.

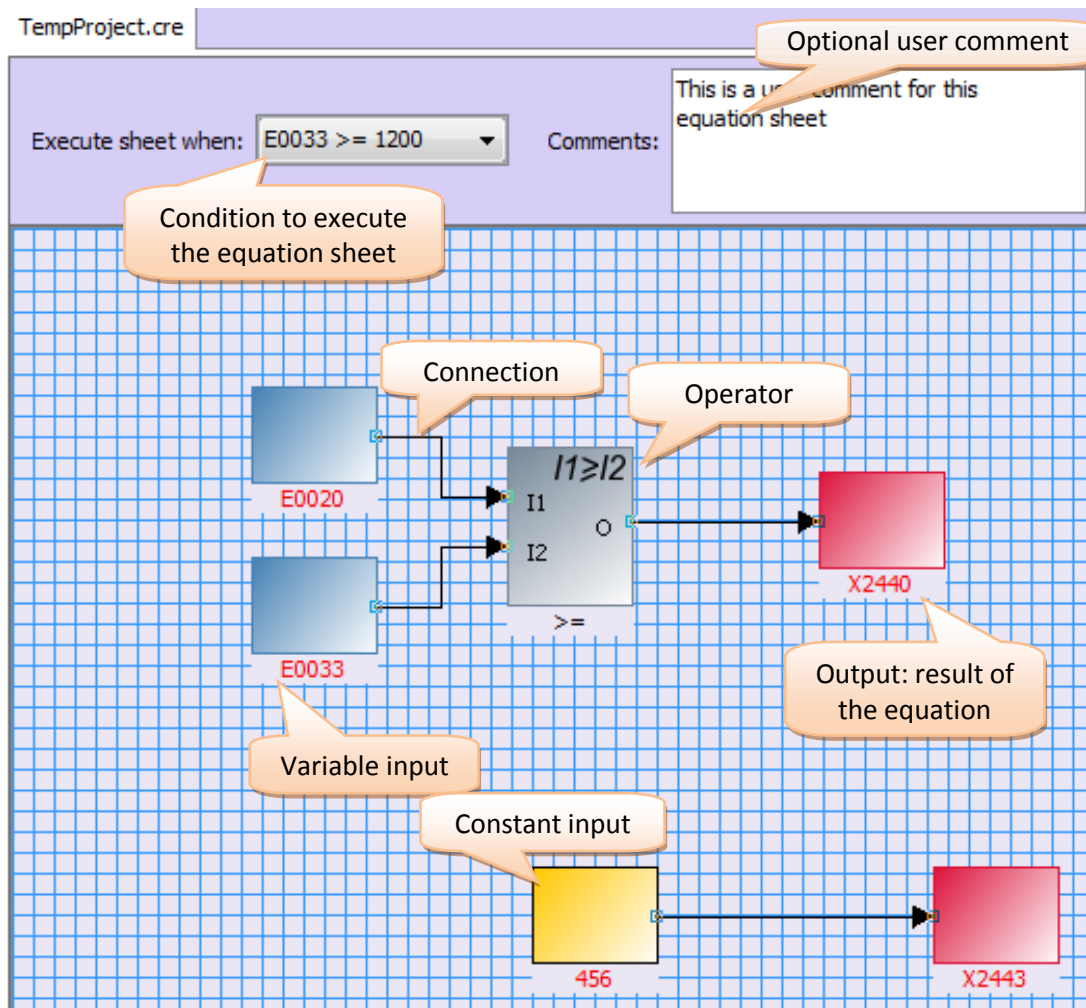

FIGURE 3: EQUATION SHEET COMPONENTS

Easy PLC includes a positioning grid for blocs. It's possible to set up its type, the grid scale and if the blocs should stick or not to it (see §6.3.1).

6.3 MAIN MENU AND TOOLBAR

Picture below shows you **Easy PLC** main menu and toolbar. This is where you will find general commands to create, save, compile and print your project. This section details each command available in this menu and toolbar.

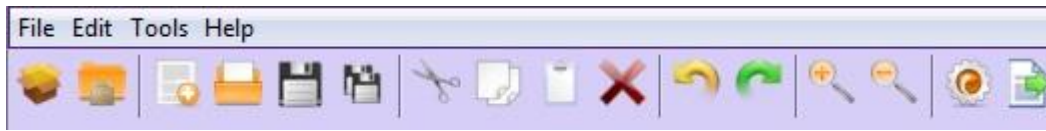

FIGURE 4: MENU AND TOOLBAR

6.3.1 MAIN MENU

File menu	
Command	Description
New project	Starts a blank new project. If a project was already open, you will be asked if you want to save it before beginning to design the new project.
Open project	Opens an existing project previously saved on your computer.
New file	Adds a new blank equation sheet to the current project. A dialog box opens so you can enter the name of this new sheet.
Open file	Opens an equation sheet from another existing project. This sheet is not copied into the current project, but you can copy its content (or a part of it) and paste it into one of the current project's sheets.
Add file	Add an existing equation sheet to the current project.
Save	Saves the current equation sheet.
Save as	Save the current equation sheet using another name. In this case, the equation sheet saved under another name is not part of the current project. For example, if you select a sheet called "Equation_1" and save it as "NewName", then sheet "NewName" is not included into the current project, but "Equation 1" still is.
Save all	Saves the current project and all of its equation sheets.
Close project	Closes the whole project and all equation sheets.
Compile	Saves all the project and try to compile it. If errors are found, a text is displayed on the bottom of the main window. Otherwise, the resulting text file is shown into your notepad. This text file can be saved on your computer to be later sent to your CRE Technology modules.
Print preview	Shows how a printed copy of the project will look like.
Print project	Prints all the equation sheets of the current project.
Print current sheet	Prints only the active sheet actually displayed in the main window.
Quit	Leaves the program. You will be asked to save your project if necessary.

TABLE 1: FILE MENU

Edit menu	
Command	Description
Undo/Redo	Cancel your last action/Reproduce a cancelled action
Cut/Copy/Paste	Cut/copy/paste your selection (single block, connected blocks...)
Delete	Delete the current selection (block, group of blocks, connection...)

TABLE 2: EDIT MENU

Tools menu	
Command	Description
Language	Changes Easy PLC display language
Zoom	Select your zoom in/zoom out ratio for the current equation sheet
Variables management	<p>Here you can add variables to be listed in the “predefined variable” lists (input/output). This can be useful if your Easy PLC version doesn’t show variables existing in a newer version of your targeted GENSYS 2.0 module. Variable name must be entered in the form :</p> <p style="text-align: center;"><i>Eⁿⁿⁿⁿ Name of your choice</i></p> <p>Where <i>nnnn</i> is the 4 digit number of the variable to add as shown in the example below.</p> <div data-bbox="722 1303 1220 1904" data-label="Image"> </div> <p>Use with caution: Easy PLC will not check if the variable you add is supported by your module or not.</p>

Tools menu	
Command	Description
Grid properties	<p>Allow you to modify the grid scale and if components (operators/blocks) will stick or not to the grid.</p> <p>Scale possible values are between 10 and 40.</p>

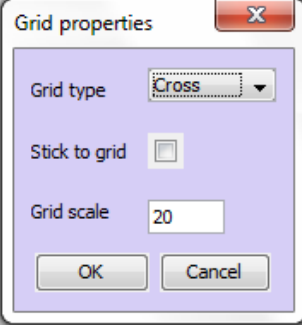







TABLE 3: TOOLS MENU

Help menu	
Command	Description
Help	This menu will open a PDF version of this manual
About	Display the version number of your Easy PLC software

TABLE 4: HELP MENU

6.3.2 TOOLBAR DESCRIPTION

The toolbar proposes shortcuts to the main commands available in the main menu. Table below describes the commands associated to each toolbar icon.

Toolbar commands		
Icon	Command	Description
	New project	Starts a blank new project. If a project was already open, you will be asked if you want to save it before beginning to design the new project.
	Open project	Opens an existing project previously saved on your computer.
	New file	Adds a new blank equation sheet to the current project. A dialog box opens so you can enter the name of this new sheet.
	Open file	Opens an equation sheet from another existing project. This sheet is not copied into the current project, but you can copy its content (or a part of it) and paste it into one of the current project's sheets.
	Save	Saves the current equation sheet.
	Save all	Saves the current project and all of its equation sheets.











Toolbar commands		
Icon	Command	Description
	Cut	
	Copy	Cut/copy/paste the current selection (single block, connected blocks...).
	Paste	
	Delete	Delete the current selection (block, group of blocks, connection...).
	Undo	Cancel your last action/Reproduce a cancelled action.
	Redo	
	Zoom in	Zooms in or out the current equation sheet to adapt the display to your needs (global view/zoom on partial part of an equation). You can also zoom in/out using your mouse wheel together with the Ctrl key: <i>Ctrl+Scroll_Up</i> to zoom in, <i>Ctrl+Scroll_Down</i> to zoom out.
	Zoom out	
	Compile	Saves all the project and try to compile it. If errors are found, a text is displayed on the bottom of the main window. Otherwise, the resulting text file is shown into the software. This text file can be saved on your computer to be later sent to your CRE Technology modules.
	Send file	Sends the selected text file to a GENSYS 2.0/MASTER 2.0 module.

TABLE 5: TOOLBAR COMMANDS

7 CREATING A PROJECT

A project is a set of equation sheets. Each equation sheet can contain one or more simple equations designed using inputs, operator blocks and output connected together.

You can also add text files to a project. Equations from these text files will be added to the result of the compilation of your equation sheets (see chapters 7.5 and 8 for further details).

This chapter describes how to manage equation sheets and how to design equations. It will detail all existing functionalities that may be useful to create your own project.

7.1 CREATING A NEW PROJECT

Easy PLC allow you to generate equations level 1 and 2. When you create a new project, you will first be asked to select the equations level for this project.

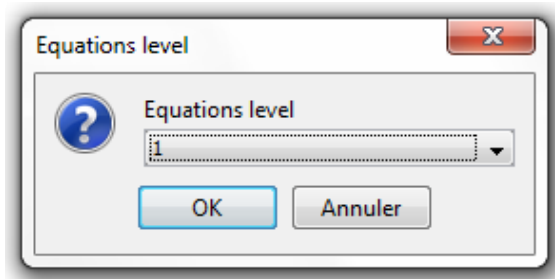

FIGURE 5: SETTING THE EQUATION LEVEL

If you open an existing project designed with an Easy PLC version older than v1.04, equation level is automatically set to 1.

You can also change this level later by right clicking on your project and selecting **Properties**.

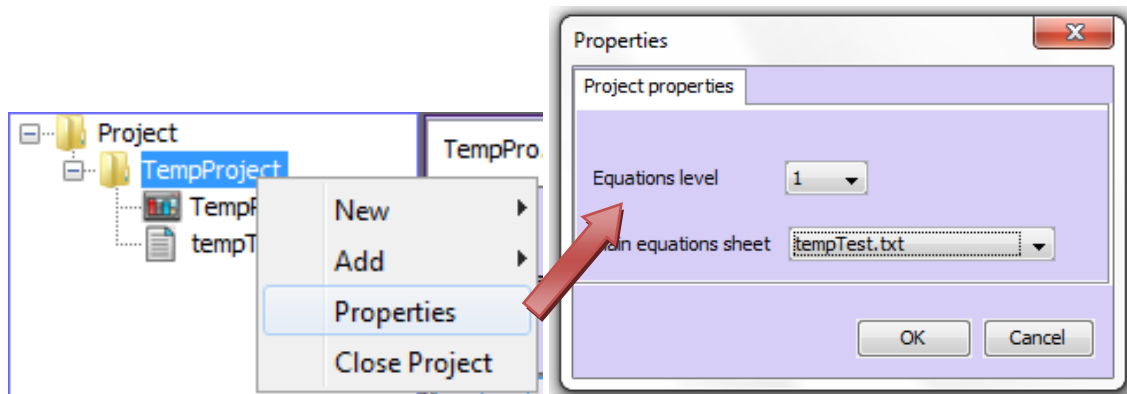

FIGURE 6: PROJECT PROPERTIES

7.2 MANAGING FILES

This chapter explains how to add, delete and rename files (equation sheets and text files) from a project. A single project can contain up to 50 equation sheets.

7.2.1 ADDING A FILE

To design multiple or complex equations, it may be necessary to create a project with multiple equation sheets (and/or text files) for a better visibility of each function. There are two ways to add a file to the

current project. Both can be accessed through a contextual menu by using a right click of your mouse on the project tree situated on the left panel of **Easy PLC** main window.

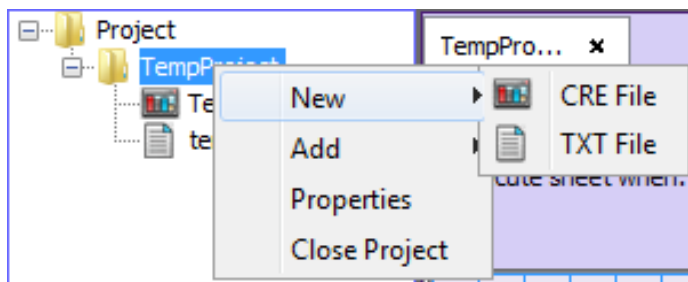

FIGURE 7: ADDING AN EQUATION SHEET

There you can choose between two options:

- **New file** will add a blank equation sheet or a blank text file to the current project. A dialog box opens so you can give a name to this new file.
- **Add file** lets you navigate through your computer to find an equation sheet or a text file previously saved using **Easy PLC**. This way you can import a file from another project. The file is copied inside the current project: if you modify it, only the new copy of the current project is modified, the original file remains unchanged.
- **Properties**, project's properties (see chapter 7.1).

7.2.2 RENAMING EQUATION SHEETS

You can change the name of your files at any time. To do so, right click on the file's name inside the project tree on the left of **Easy PLC** main window, select **Rename** in the contextual menu that appears and enter the new name in the dialog box.

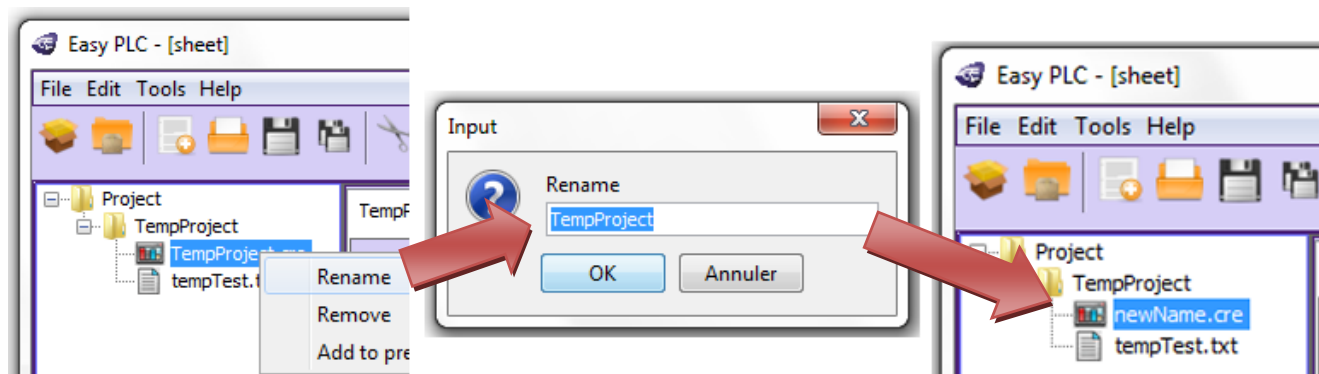

FIGURE 8: RENAMING AN EQUATION SHEET

7.2.3 SORTING FILES

Equations will be treated in your target module (e.g. GENSYS 2.0) in the same order as they are sorted in your project tree. If you need to change this order, you can simply drag and drop a file's name in the project tree as shown in the two pictures below.

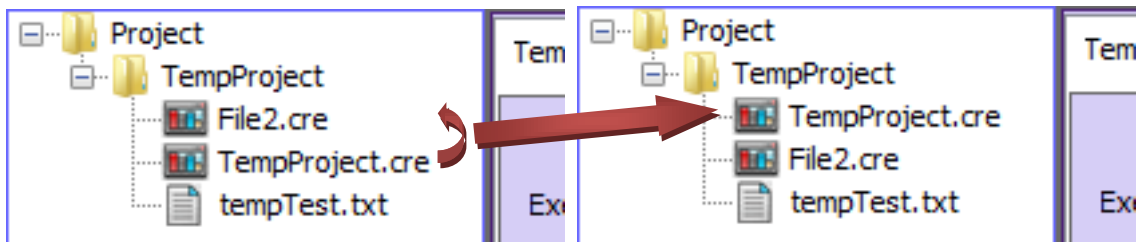

FIGURE 9: SORTING EQUATION SHEETS

7.2.4 REMOVING FILES

If you want to completely remove a file from your project, right click with your mouse on the file's name in the project tree, then select **Remove** in the contextual menu that appears. A dialog box will open to confirm that you want to remove this equation sheet.

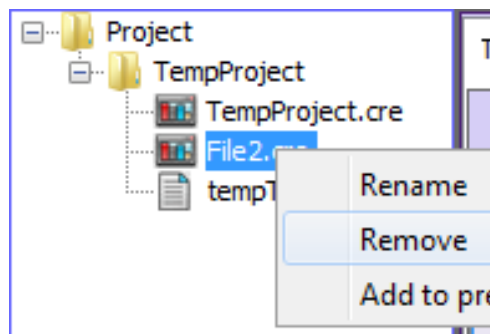

FIGURE 10: REMOVING EQUATION SHEETS

7.3 EQUATION EXECUTION CONDITION

Easy PLC lets you add an execution condition for each equation sheets of the project. This means that the content of a sheet will be executed:

- **Always**, meaning at each target PLC cycle (i.e. every 100ms for the GENSYS 2.0 family internal PLC).
- **Variable**, meaning only when a specific condition is met. For example only when variable E2440 is greater than 3.
- **Never** (Useful to disable a sheet without removing it from your project).

An execution condition can be a comparison between a variable and a constant value, or a comparison between two variables. For example:

- $E2440 > 3$.
- $E2057 = 6$.
- $E2071 \# 0$ (i.e. E2071 **different from** 0).
- $E2440 \leq E2441$ (i.e. E2440 lower than or equal to E2441).

To enter a specific condition for the current equation sheet, first select **“Variable”** in the field **“Execute sheet when”**. A dialog box appears that lets you define the different items of your executing condition (variable, comparison sign, variable or constant value). Pictures below show how to execute a sheet only when variable E2440 is different from 3 (i.e. not equal to 3).

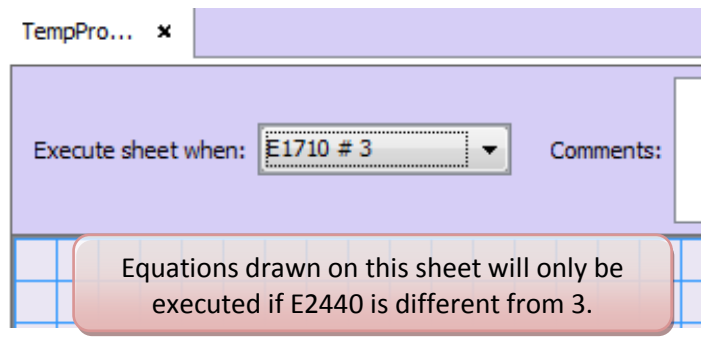
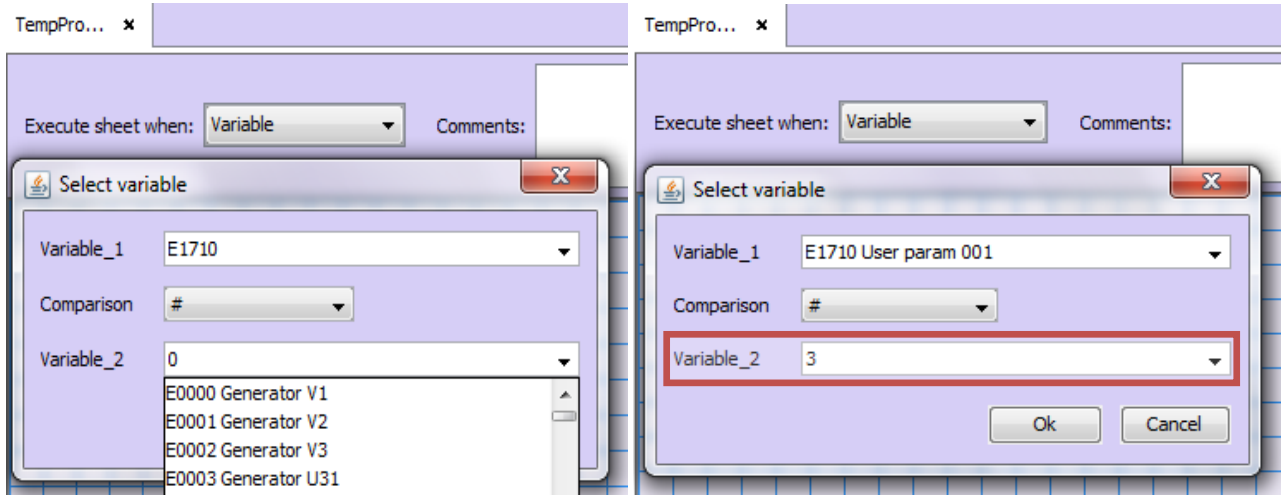
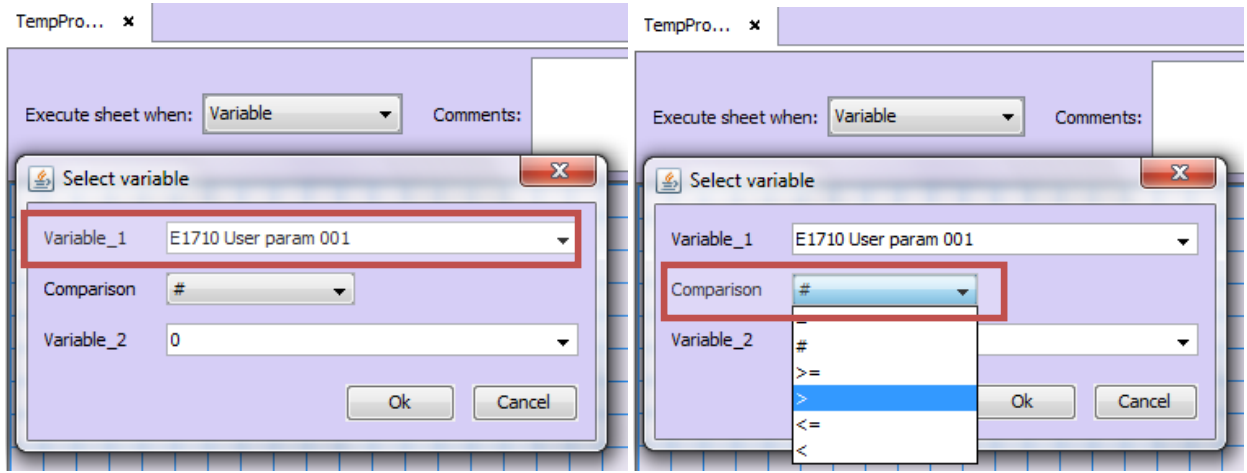
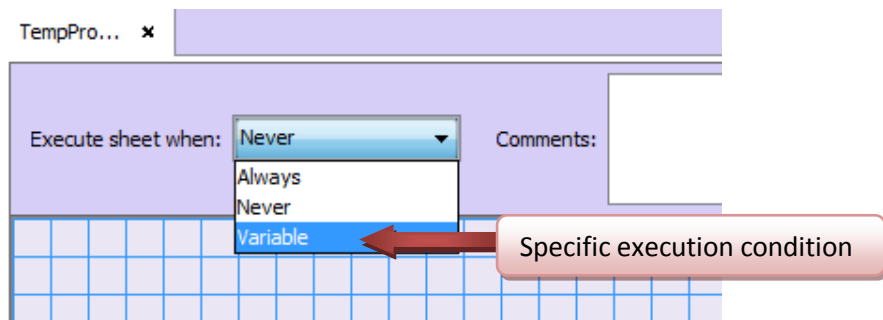

7.3.1 IF.../ELSE CONDITION

If you ever need to use conditions like *If.../Else...*, then you will have to use 2 equation sheets. The first one will be used to draw equations that need to be executed when the **condition is TRUE** (If...) and the second sheet will be used to draw equations that need to be executed when the **opposite condition is TRUE** (Else...).

For example with the following program:

```

If E1710>3 Then
    Execute equation A
Else
    Execute equation B
End If
    
```

<-- Meaning when E1710 is lower than or equal to 3

In this case, create 2 equation sheets with the following execution condition:

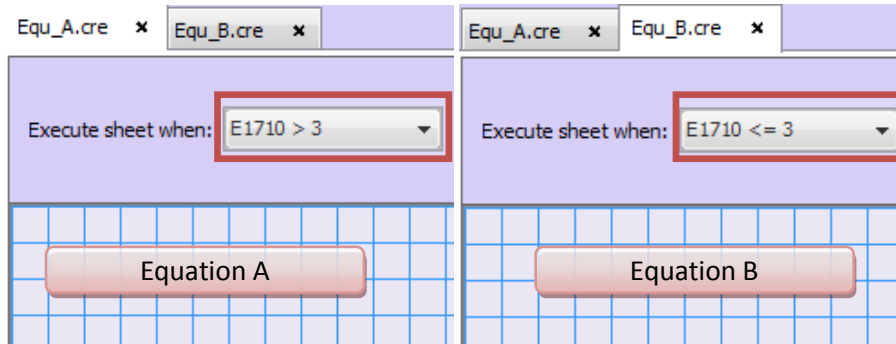
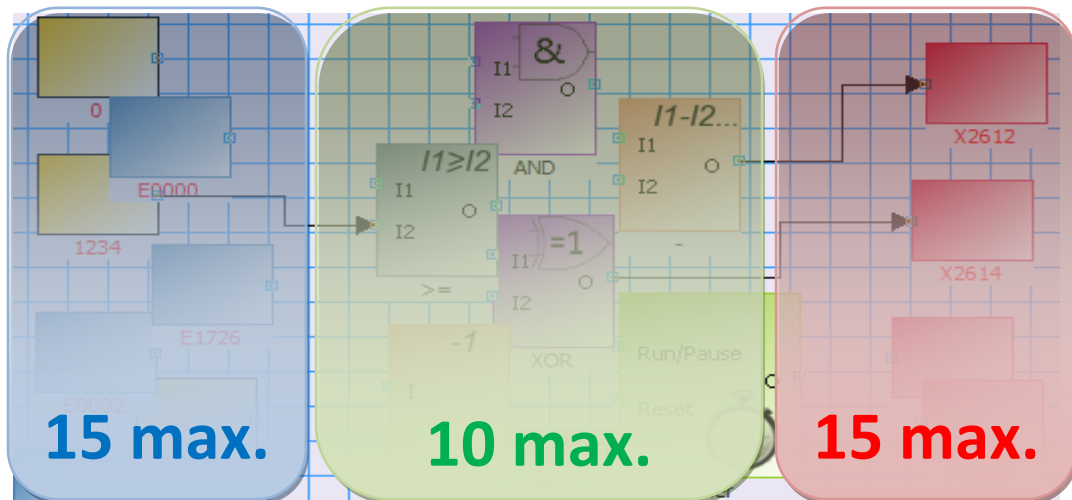

FIGURE 11: IF/ELSE CONDITION

7.4 DESIGNING AN EQUATION

An equation sheet contains one or more simple equations. An equation is a set of inputs (constant values or GENSYS 2.0 internal variables), operators (logic, arithmetic...) and outputs (GENSYS 2.0 internal variables). Each equation sheet can contain up to:

- 15 inputs (constant or variable inputs).
- 15 outputs.
- 10 operator blocks.



You can add Input/Constant/Output/Operator blocks on the current equation sheet using a double click on the block or using drag & drop. You can also add an operator using a double click on the equation sheet.

7.4.1 EQUATION INPUTS

Inputs are data that are used inside an equation to perform a calculation, a comparison or any other simple operation. Inputs can be of two types:

- Constant inputs are constant values that cannot be changed by the end user.
- Variable inputs are all the internal variables handled by your target module. For example all GENSYS 2.0 measurements (kW, oil pressure, CANopen inputs...), parameters (kW setpoint, overspeed protection setpoint, cool down duration...) and calculation data (Power status, load sharing setpoint, logic output status...) can be used as data inputs for your equations.

To use any input in your equation, first select “Input” in the **Type** field of the right panel. This will give you a list containing “Constant” plus all existing variables as shown below.

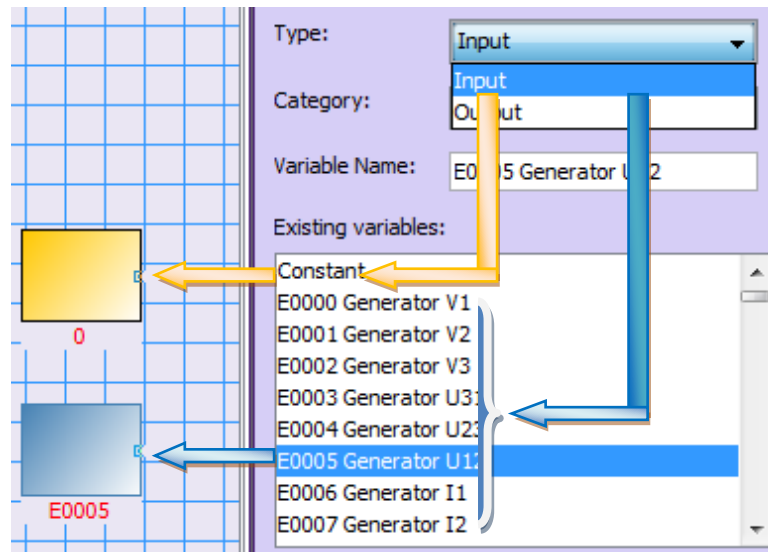

FIGURE 12: INPUT SELECTION

The list of available inputs is quite long. You can filter it by selecting a **Category** or typing a part of the input name you are looking for. For example if you want to use a variable containing “kW” in its name, then type kW in the **Variable name** field as shown below. Clear this field to get the complete list again.

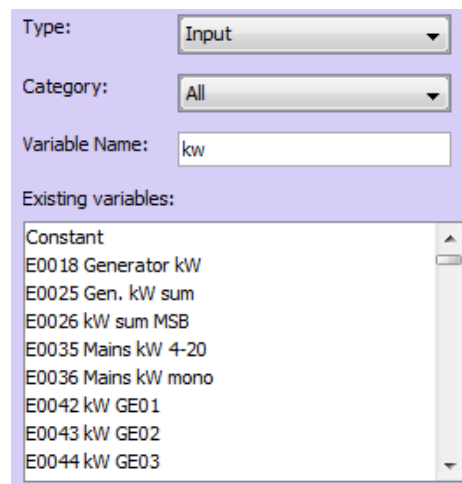

FIGURE 13: INPUT FILTERING

You can now choose the desired input and add it to the equation sheet using your preferred method:

- Drag selected input with your mouse and drop it in the current equation sheet.
- Double click on the desired input in the “Predefine variable list: it will be automatically added into the equation sheet.

NOTE:

Constant input value can be changed by double-clicking on a constant block placed in the current equation sheet as shown below.

You can also modify the input block (or output block) variable by double-clicking on it and replacing its actual name by another existing input variable (or output variable).

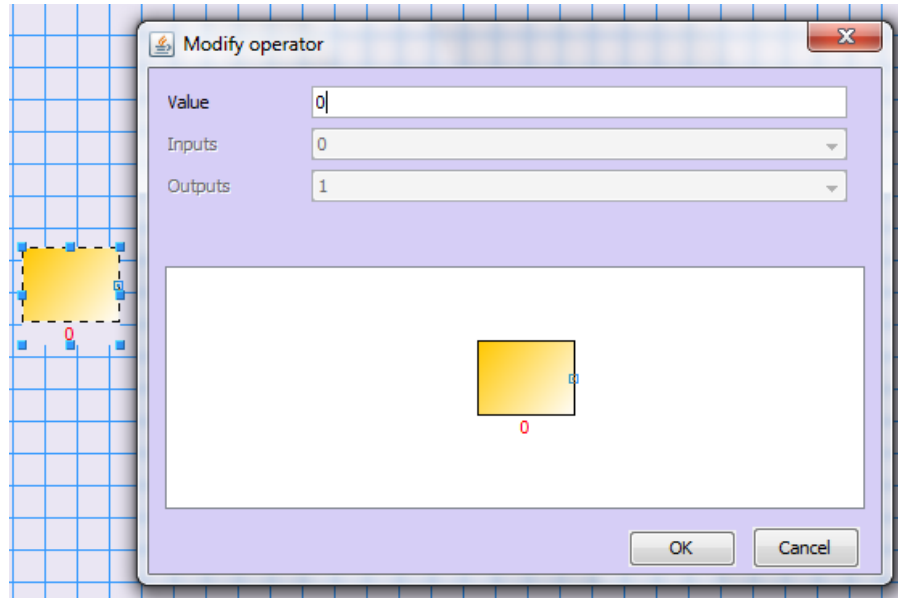

IMPORTANT:

Equations can only handle 16 bits signed integer data. This means that:



- *Constant value must be an integer value (e.g. 1234 but not 45.67).*
 - *Constant value must be set between -32768 and +32767.*
 - *Data displayed by the target module as real values are internally treated as integer values (e.g. Battery voltage E0041 which is displayed on GENSY 2.0 LCD screen as 24.0V is seen as equal to 240 by GENSY 2.0 microprocessor).*
- Contact CRE Technology or your local distributor for training courses concerning your module's internal PLC and equation programming.*
-

7.4.2 EQUATION OUTPUTS

Outputs will contain the result of your equations. As for inputs, you must first select "Output" in the **Type** field of the right panel to get the list of all existing outputs as shown by the picture below.

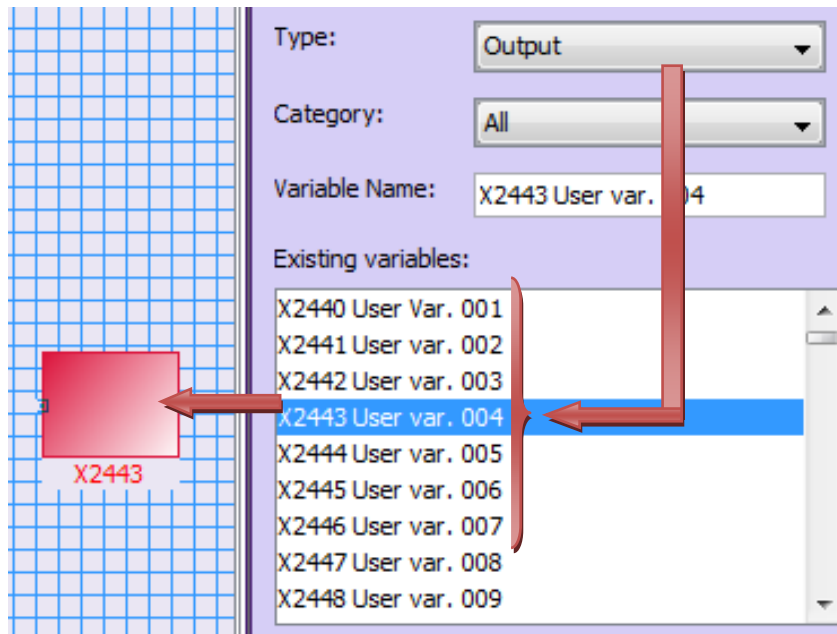

FIGURE 14: OUTPUT SELECTION

Select the desired output and add it to the current equation sheet as you did for the inputs (double click on the output name or drag and drop it with your mouse).

You will usually want to use outputs from the following categories:

- **User variables** and **user parameters** (free for the end user).
- **Spare outputs** C1 to C5 (X2020 to X2024)
- CANopen outputs (CANopen remote logic and analog outputs).

Use **Category** field to filter the output list and reduce it to the desired output category.



WARNING:

Most existing outputs are already calculated and used internally by the target module (GENSYS 2.0, MASTER 2.0...). It is dangerous to use such outputs for your own equations. Contact CRE Technology or your local distributor for training courses concerning your module's internal PLC and equation programming.

1/ Writing into a configuration parameter:

Outputs can be internal variables (for example E2440 which is a user variable) or may also be configuration parameters if you wish to dynamically change your module. For example you can change the language used on your module's LCD screen depending on a selector button connected on a logic input (E2810 = input J10 in the example below) of your module. In this example, "Local language" parameter E1156 will be the output of your equation.

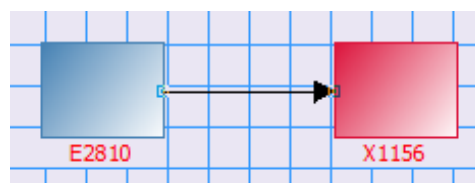

FIGURE 15: PARAMETER USED AS AN OUTPUT

Parameters are factory set to **Read only** as default in your target module. In this example parameter E1156 should be switched to **Read/Write** so the equation can effectively write into this parameter. Starting from version 1.04, **EasyPLC** automatically sets such parameters as “write enabled”. In older Easy PLC versions this must be done manually on your target module. To do so, refer to your module’s technical documentation.





7.4.3 EQUATION OPERATORS

Easy PLC contains different categories of operators that can be combined together to design your equations. Operators are listed in the top right panel of **Easy PLC** main window. You can add operators on the current equation sheet using 3 methods:

- Drag and drop an operator from the right list into the equation sheet.
- Double click on the operator’s name in the top right list.
- Double click on an empty space of the equation sheet and select the desired operator in the dialog box that appears.

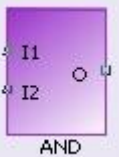
Operators are classified in 4 different categories as described in the tables below.

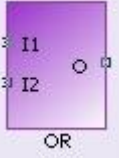
Note: Always connect all operator inputs. If a connector input (or output) is left unconnected, then an error will be issued during compilation.

Logic operators		
Operator	Name	Function
	AND⁽¹⁾	Output is set to 1 if all inputs are different from 0, otherwise output is set to 0
	NAND⁽¹⁾	Output is set to 0 if all inputs are different from 0, otherwise output is set to 1
	OR⁽¹⁾	Output is set to 1 if at least one input is different from 0. Otherwise output is set to 0.
	XOR⁽¹⁾	Output is set to 1 if only one input is different from 0. Otherwise output is set to 0.
	NOT	If input is 0 then output is set to 1, otherwise output is set to 0.





Logic operators		
Operator	Name	Function
	Reverse	Output is equal to Input*-1.
	Rising Edge ^{(2) (3)}	Output is equal to 1 when input switches from a null or negative value (≤ 0) to a value greater than zero (>0).
	Falling Edge ^{(2) (3)}	Output is equal to 1 when input switches from a positive value (>0) to a null or negative value (≤ 0).
	RS flip-flop ⁽²⁾⁽³⁾	<p>Output is set to 1 when input S is positive and input C switches from a negative to a positive value.</p> <p>Output is set to 0 when input R is positive and input C switches from a negative value to a positive value.</p> <p>R input has priority over S input. If both S and R inputs are positive and input C switches from a negative (≤ 0) to a positive value, then the output is set to 0.</p> <p>A negative value is lower or equal to 0. A positive value is greater or equal to 1.</p> <p>/Q output is the complement of Q: If Q is equal to 1 then /Q is equal to 0; If Q is equal to 0 then /Q is equal to 1.</p>
	D flip-flop ⁽³⁾	<p>When input C switches from a negative value to a positive value then output Q is set to the current value of input D.</p> <p>A negative value is lower or equal to 0. A positive value is greater or equal to 1.</p> <p>/Q output is the complement of Q. if Q is equal to 1 /Q is equal to 0 and if Q is equal to 0, /Q is equal to 1.</p>

TABLE 6: LOGIC OPERATORS

Notes concerning logic operators:

- (1) You can double click on these blocks to increase the number of inputs as shown below.

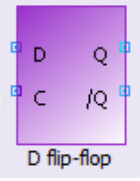
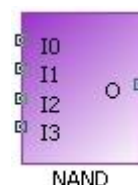

FIGURE 16: NAND BLOCK WITH 4 INPUTS

- (2) These operators require the use of additional variables for internal calculation purpose. Double click on the block and select a free user variable to be used as temporary calculation.

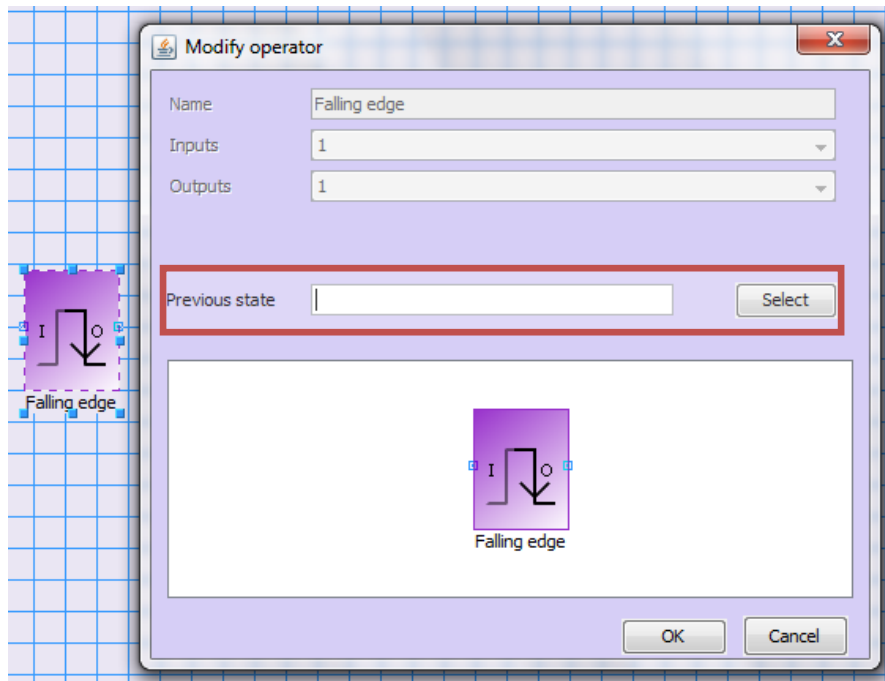

FIGURE 17: FILLING INTERNAL VARIABLES OF AN OPERATOR

(3) These operators must be directly connected to an output block.

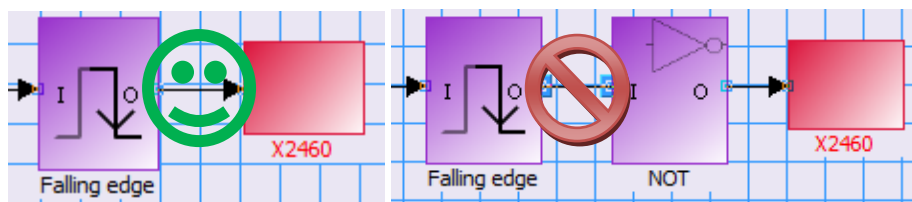

FIGURE 18: BLOCK MUST BE CONNECTED TO AN OUTPUT.

Arithmetic operators		
Operator	Name	Function
	Plus ⁽¹⁾⁽³⁾	Output is the sum of all inputs.
	Minus ⁽¹⁾⁽³⁾	Output is equal to I1 minus all other inputs (e.g. for a 3 inputs block, output is equal to I1-I2-I3).
	Multiply ⁽¹⁾⁽³⁾	Output is the product of all inputs.



Arithmetic operators		
Operator	Name	Function
	Divide ⁽³⁾	Output is equal to I1/I2.
	Increment ^{(2) (3)}	Input variable is increased by 1.
	Decrement ^{(2) (3)}	Input variable is decreased by 1.

TABLE 7: ARITHMETIC OPERATORS

Notes concerning arithmetic operators:

- (1) You can double click on these blocks to increase the number of inputs as shown below.

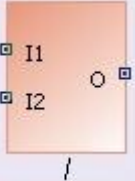
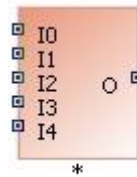

FIGURE 19: MULTIPLY OPERATOR WITH 5 INPUTS

- (2) Blocks **INC** and **DEC** have no graphical output. In fact, their input is also their output. This means that you can only connect a variable input to these blocks. Do not connect a constant input or the output of another block.

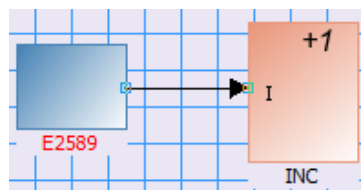

FIGURE 20: CONNECTION TO AN INC OPERATOR

(3) IMPORTANT:

Equations can only handle 16 bits signed integer data. This means that:



- *Calculation cannot handle values below -32768 or above +32767. For example, "20000+25000" will not result in a value of 45000: an overflow will occur and the result will be erroneous.*
 - *Divisions result in integer values. For example, "8/10" will give "0" as a result.*
- Contact CRE Technology or your local distributor for training courses concerning your module's internal PLC and equation programming.*

Comparison operators		
Operator	Name	Function
	Equal	Output is set to 1 if I1 is equal to I2. Otherwise, output is set to 0.
	Not equal	Output is set to 1 if I1 is different than I2. Otherwise, output is set to 0.
	Greater than	Output is set to 1 if I1 is greater than I2. Otherwise, output is set to 0.
	Greater or equal	Output is set to 1 if I1 is greater than or equal to I2. Otherwise, output is set to 0.
	Lower than	Output is set to 1 if I1 is lower than I2. Otherwise, output is set to 0.
	Lower or equal	Output is set to 1 if I1 is lower than or equal to I2. Otherwise, output is set to 0.

TABLE 8: COMPARISON OPERATORS

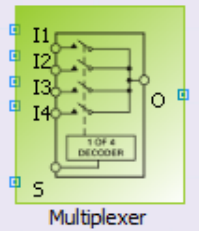
Special functions operators		
Operator	Name	Function
	Multiplexer⁽¹⁾	<p>Output is set equal to one of the “n” Ix inputs depending on the value of input S (Select) as described below:</p> <ul style="list-style-type: none"> • If S is equal to 0, then Output = I1. • If S is equal to 1, then Output = I2. • If S is equal to 2, then Output = I3. • If S is equal to 3, then Output = I4. • Otherwise, Output is not modified.

Special functions operators		
Operator	Name	Function
	Timer ^{(2) (3)}	Output is set to 1 when RUN/PAUSE input has been set to 1 during TOP number of equation cycles without any RESET. See detailed description below.
	Filter ^{(2) (3)}	This block can be used as a simple filter for analog signals. See detailed description below.

TABLE 9: SPECIAL FUNCTIONS OPERATORS

Notes concerning special function operators:

(1) Since 1.02 version, you may:

- Let non connected inputs for this operator. However, it is necessary to have a least one input connected plus the selector signal. If a constant is connected to the selector, an error is shown during the compilation.
- Modify the number of inputs (From 2 to 8) by double-clicking on the component as shown on the screenshot below:

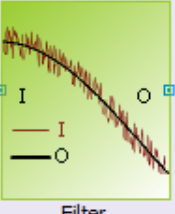
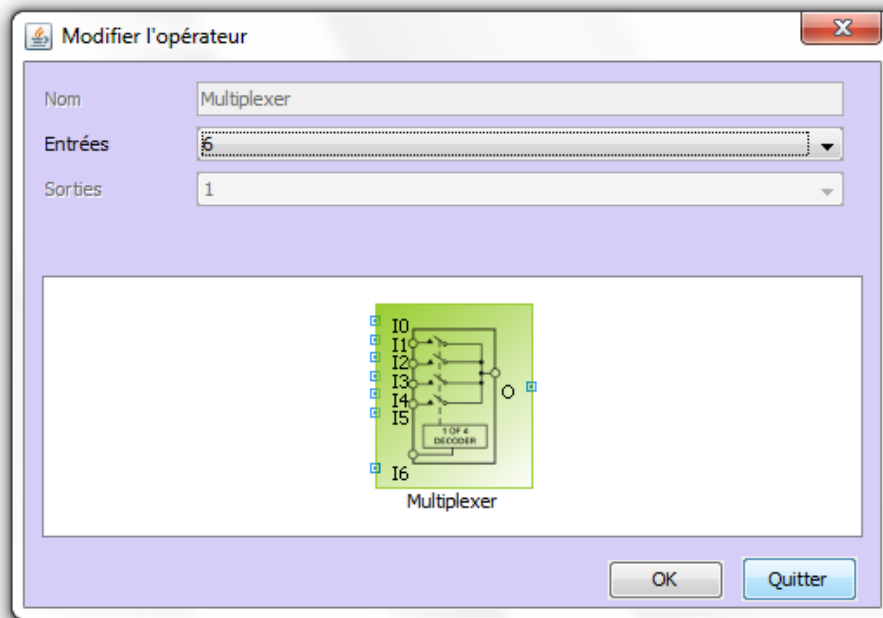

FIGURE 21: MODIFYING THE NUMBER OF INPUTS OF A MULTIPLEXER



IMPORTANT:

It is not possible to use two multiplexers in the same equation. Whether by a direct link (the output of one multiplexer directly connected to an input of another multiplexer) or by an indirect link (two multiplexers in the same blocks chain even if they are not directly tied together).

(2) These operators must be directly connected to an output block.

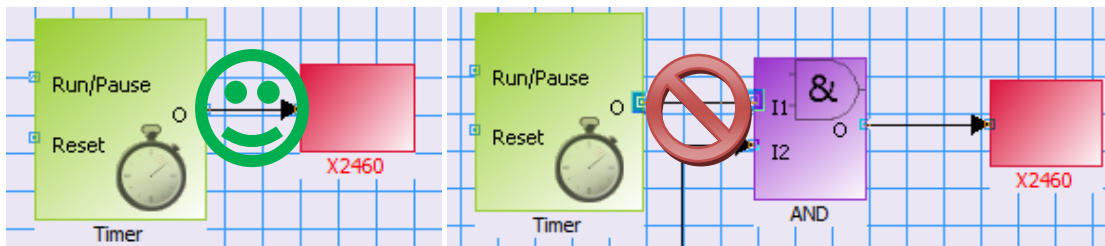

FIGURE 22: BLOCK MUST BE CONNECTED TO AN OUTPUT

(3) These operators require the use of additional variables for internal calculation purpose. Double click on the block and select free user variables to be used as temporary calculation.

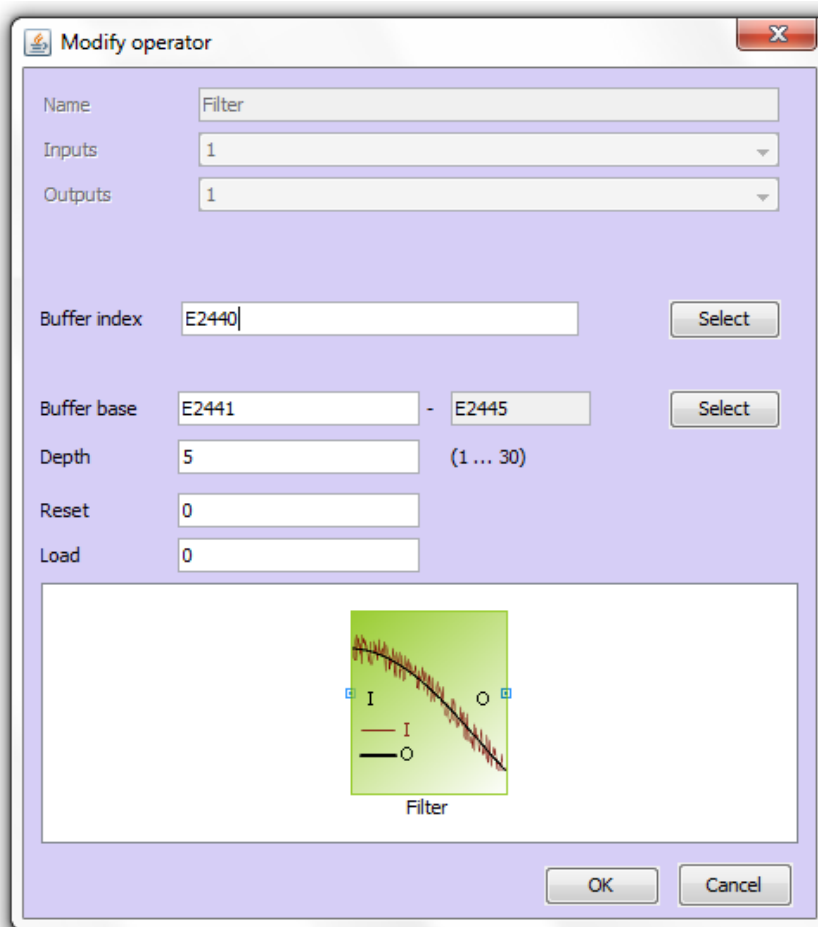

FIGURE 23: FILTER BLOCK INTERNAL VARIABLES

1/ Timer operator

Timer operator increases an internal variable called **COUNTER** each time the **RUN/PAUSE** input is different from 0. When **RUN/PAUSE** is equal to 0, internal variable **COUNTER** is not changed. The duration of this timer is set by internal value **TOP**. When **COUNTER** reaches value **TOP**, then output **O** is set to 1.

When **RESET** input is different from 0, then both **COUNTER** and **O** are reset to 0.

Internal variable **COUNTER** must be defined by double clicking on the timer operator. A dialog box appears to let you choose the variable to be used.

Chronogram below shows a timer operator that encounters the following events:

- 1) **RESET**. Output and internal values are set to zero.
- 2) Successive **RUN** and **PAUSE** periods until **COUNTER** reaches **TOP** value and output **O** is set to 1.
- 3) A new **RESET** is applied which makes **COUNTER** and **O** switch back to 0.

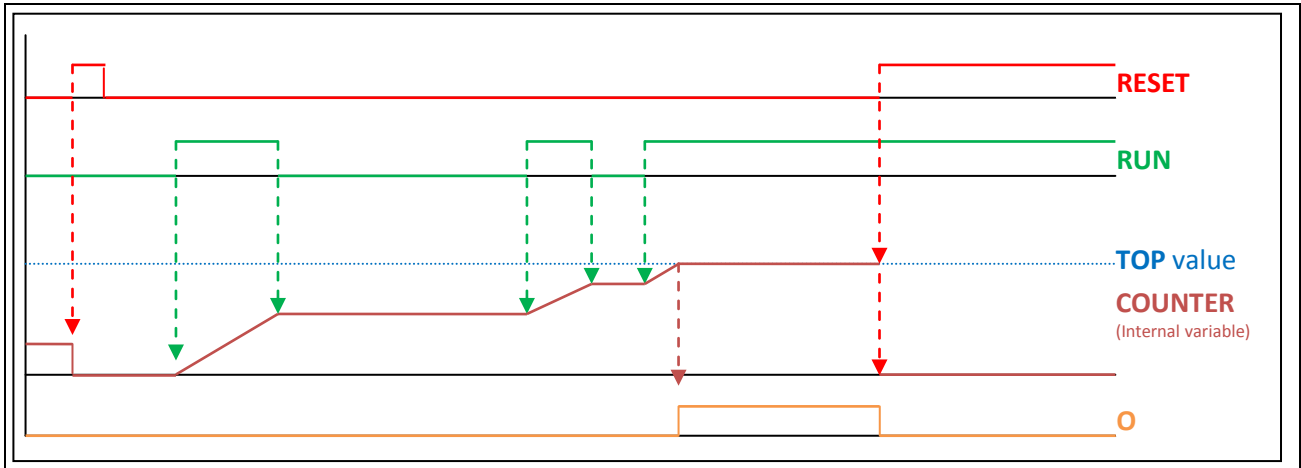

FIGURE 24: TIMER OPERATOR CHRONOGRAM

NOTES: * As an example, when used in an equation sheet that is always executed (i.e. each 100ms inside a GENSYS 2.0 family product), a timer continuously run (**RUN** always equal to 1) with a **TOP** value of 125 will take 12.5 seconds ($125 \cdot 100\text{ms}$) to set its output **O** to 1.

*Timer operator can also be used as a counter. In fact, this operator counts the number of PLC cycles where **RUN** input is different than 0.

2/ Filter operator

Filter operator is a simple low pass filter that can be used for analog signals (typically for noisy analog senders' measurements). The filtering level can be adjusted depending on your needs. Picture below shows an example of signal filtering using a **DEPTH** value of 10 and 25.

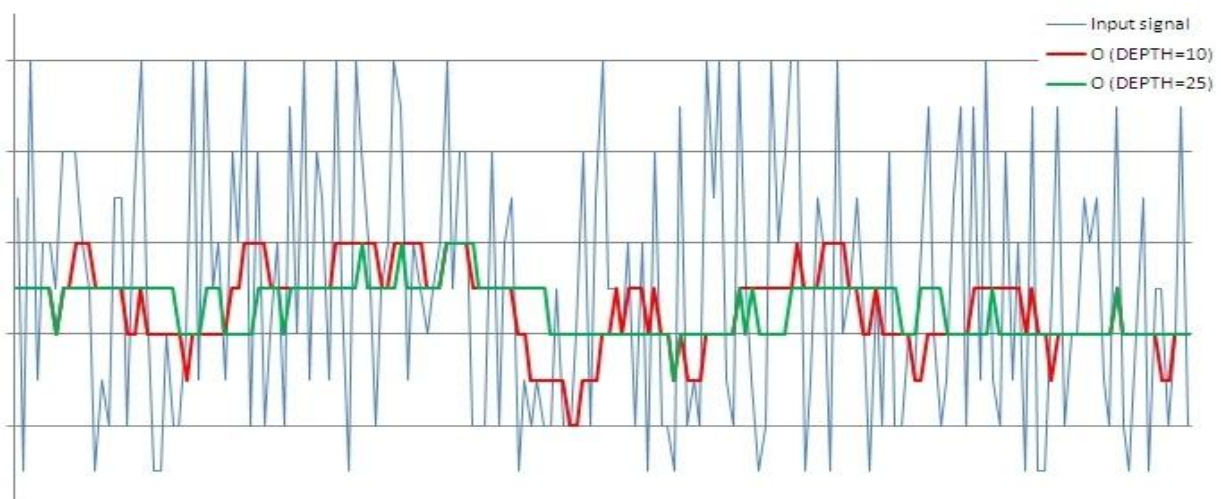
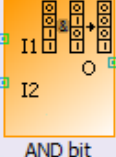
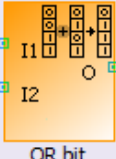
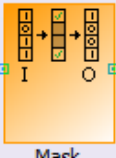
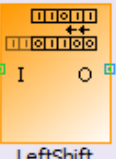
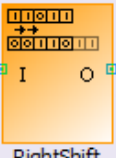

FIGURE 25: FILTER EXAMPLE

Filter operator uses internal variables to perform signal calculations. Double click on the filter block and select internal variables to be used:

- **DEPTH** defines the filtering level applied to the input signal. The higher **DEPTH** is, the more the input signal will be filtered. **DEPTH** value can be set between 1 and 30 (see note below).
- **BUFFER INDEX** is a variable used for the filter internal calculation. Select a free user variable.
- **BUFFER BASE** is the first of consecutive variables used for internal calculation. For example if **DEPTH** is set to 3 and **BUFFER BASE** is set to E2441, then 3 consecutive variables starting from E2441 (i.e. E2441, E2442 and E2443) will be used as an internal buffer for the filtered signal calculations. In this example, it means that you shouldn't use E2442 and E2443 in another equation as they will be used by this filter block.
- **RESET**: you can select a variable to control the **RESET** of the filter, or leave it to 0 if you don't need this feature. If **RESET** signal is different than 0, then filter output is set to 0.
- **LOAD**: you can select a variable to **LOAD** the filter with the current input value, or leave it to 0 if you don't need this feature. If **LOAD** signal is different than 0 (and **RESET** is set to 0), then filter output is set to the current input value.

*NOTE: Keep in mind that PLC calculation uses 16 bits signed integer data. This means that all calculations and values are limited between -32768 and +32767. In the case of a filter block, average value of the input signal I should never be above value $32767/DEPTH$ or below $-32768/DEPTH$, otherwise calculation errors will occur. For example if you set **DEPTH** value to 30, input signal mean value should be kept below $32767/30=1092$ (integer value).*

Bit access operators		
Operator	Name	Function
 <p>AND bit</p>	AND_Bit ⁽¹⁾	The output is the result of a bitwise AND between the two variables connected to the inputs.
 <p>OR bit</p>	OR_Bit ⁽¹⁾⁽⁵⁾	The output is the result of a bitwise OR between the two variables connected to the inputs.
 <p>Mask</p>	Mask ⁽²⁾	The output is the result of a mask applied to the connected input. Mask value is set by the user (see note).
 <p>LeftShift</p>	LeftShift ⁽³⁾	The output takes the value of the connected input shifted to the left by "n" bits (16 by default).
 <p>RightShift</p>	RightShift ⁽³⁾	The output takes the value of the connected input shifted to the right by "n" bits (16 by default).

Bit access operators		
Operator	Name	Function
 SetBit	SetBit ⁽⁴⁾⁽⁵⁾	Sets bit “n” of the selected output to 0 or 1 depending on the input’s value (0 or different from 0).

TABLE 10: BIT ACCESS OPERATORS

Notes concerning bit access operators:

- (1) You may set up the number of bits to which the operation will be applied. For example, if you are only interested by the five least significant bits, double click on the operator to show the configuration window (illustration below) and set the “Size” value to 5.

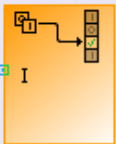
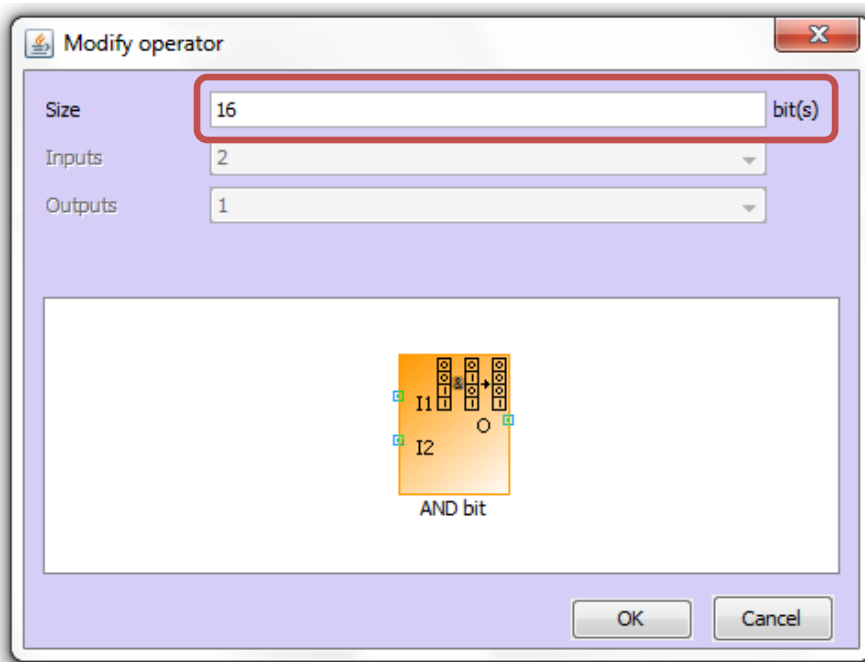

FIGURE 26: SETTING THE BIT NUMBER

- (2) To change the numeric value, double click on the operator to show its configuration window :

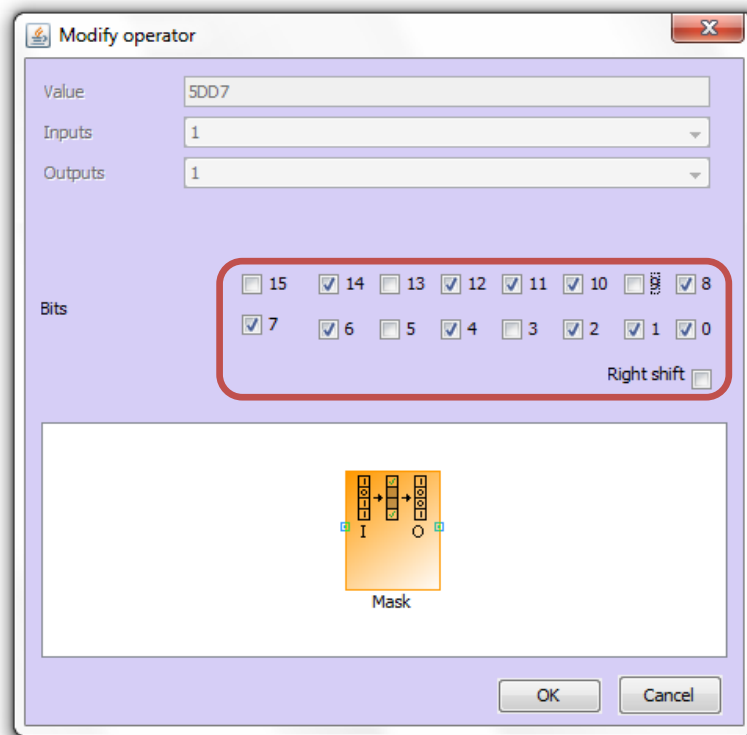

FIGURE 27: CONFIGURATION OF A MASK OPERATOR

Next you have to select the bits you are interested in. The corresponding value is shown in hexadecimal. Finally, you can choose to check the option **Right shift** which shifts the result of the mask.

For example, if your mask is: 1100 0010 1110 0100 and the shift option is checked, the result of the mask will be shifted by 2 bits to the right.

- (3) To change the number of bits to shift the input, double click on the operator to show its configuration window:

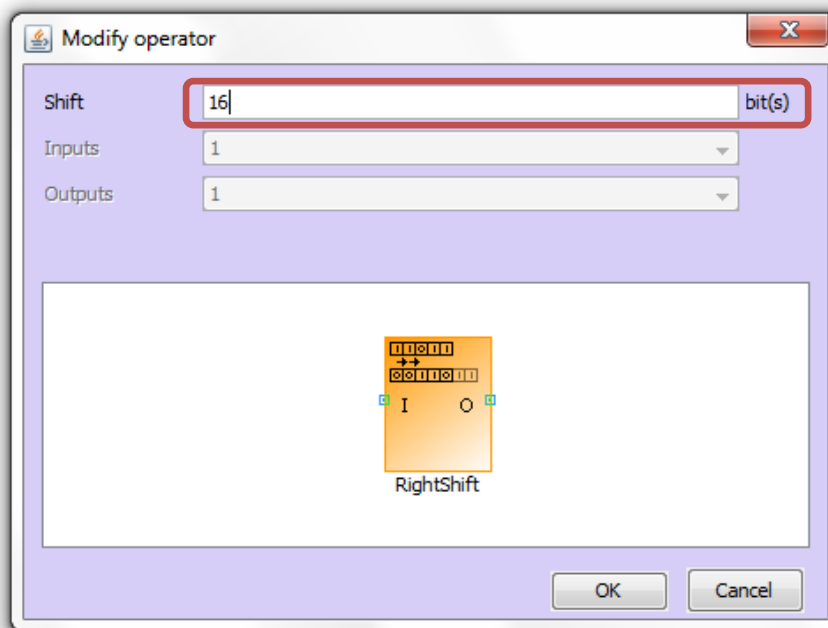

FIGURE 28: SETTING A BIT SHIFT

Change the value "16" by the desired number of bits.

- (4) To choose the output variable and the bit you want to modify, double click on the operator to show its configuration window:

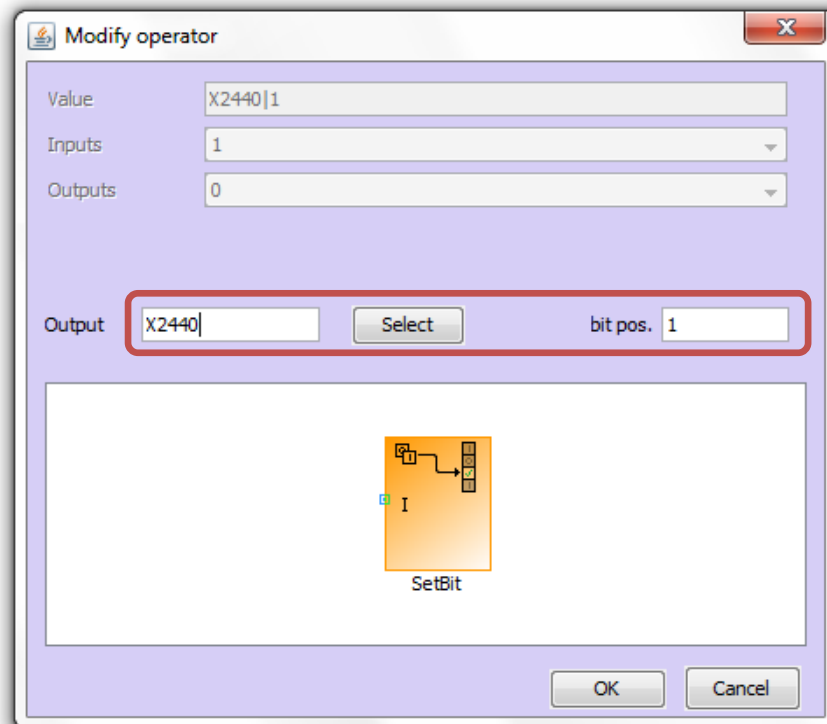
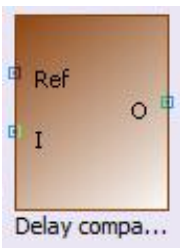

FIGURE 29: CONFIGURATION OF A SETBIT OPERATOR

Then, fill in the **Output** and **bit pos.** fields. You can directly type the name of the output variable if you know it, or you can click on the **Select** button to access to a list of output variables. The output's bit selected will be set to 1 if the value of the input is different from 0. Else, it's set to 0.

- (5) You can't connect a constant as an input of these blocks or place them in the middle of an equation. Only input variables are allowed. Moreover, the output of an OR_bit can only be directly connected to an output variable.

Comparators		
Operator	Name	Function
	<p>Delay comparator (1) (2)(3)</p>	<p>Output is initially set to 0. When the I input is greater than the Ref input, a counter (its value is set by the user) is started. If the I input stays greater than the Ref input during all the duration of the counter, then the output is set to 1. Otherwise output is kept to its current value and the counter is reset.</p> <p>Once the output is equal to 1 and if the I input is lower than the Ref input, then the internal counter is started. If the I input stays lower than the Ref input during all the duration of the counter, then the output is set to 0. Otherwise it is kept to its current value and the counter is reset.</p>



Comparators		
Operator	Name	Function
 <p>Range comp...</p>	Range comparator ⁽³⁾	The output is equal to 1 if the I input is between Hi input's value and Lo input's value. Otherwise it is set to 0.
 <p>Hysteresis c...</p>	Hysteresis comparator ⁽³⁾	The output is equal to 1 when the I input is greater or equal to Hi input's value. The output is equal to 0 when the I input is lower or equal to Lo input's value.

TABLE 11: COMPARATORS

(1) This chronogram explains how works the delay comparator :

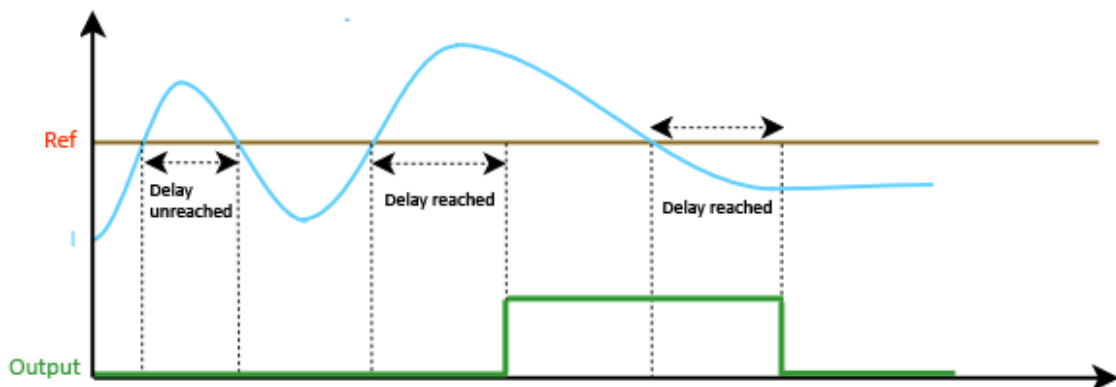

FIGURE 30: CHRONOGRAM OF A DELAY COMPARATOR

(2) This operator contains internal variables which must be initialized.

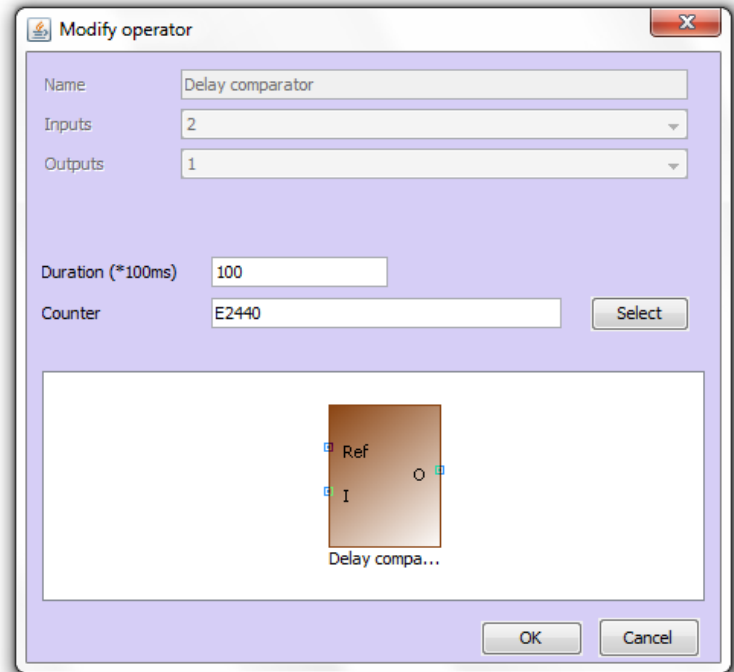

FIGURE 31: FILLING THE INTERNAL VARIABLES OF AN OPERATOR

(3) This operator must be directly connected to an output bloc.

7.4.4 MANAGING BLOCK CONNECTIONS

Once all needed input, output and operator blocks are placed on the equation sheet you can connect them together using your mouse: click on a connection square and drag the connection to its opposite connection point as shown below.

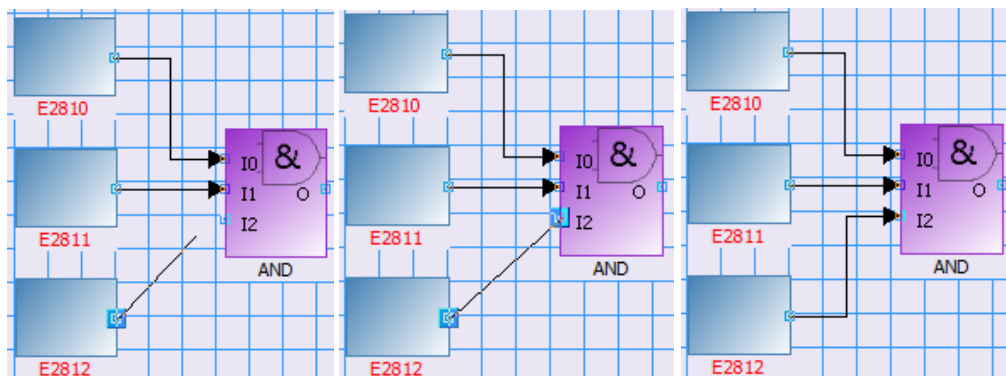

FIGURE 32: CREATING A BLOCK CONNECTION

Table below details the different action you can do on your connections:

Action	How
Move	Click on the connection, select the vertical part and drag it with your mouse.
Delete	Click on the connection and press <i>Delete</i> key on your keyboard.
Add a corner	Select the connection and right click where you want to add a corner. A new square will appear to show the new corner. You can now drag it where desired.
Remove a corner	Select the connection and right click on the corner you want to delete.

TABLE 12: CONNECTIONS POSSIBILITIES

Picture below shows a connection with additional corners.

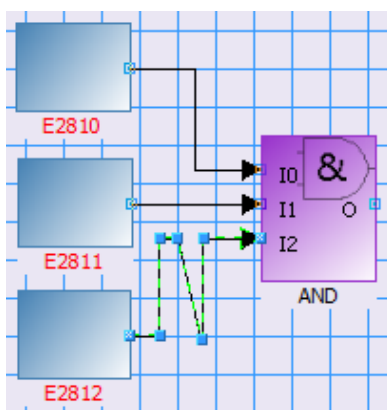

FIGURE 33: CONNECTION WITH ADDITIONAL CORNERS

7.4.5 PREDEFINED FUNCTIONS LIBRARY

1/ Principle

Easy PLC has a predefined functions library. You can see it just below the operator's one.

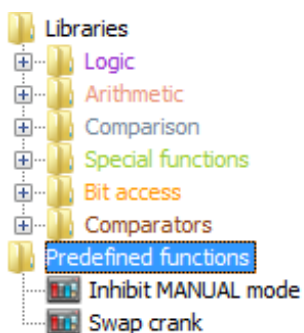

FIGURE 34: PREDEFINED FUNCTIONS LIBRARY

It contains basic functions that you can include in your project just by double clicking on them.

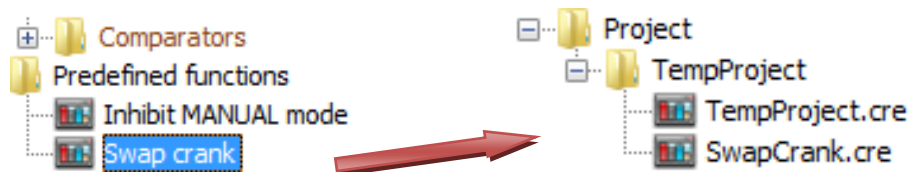

FIGURE 35: ADD A PREDEFINED FUNCTION TO YOUR PROJECT

Also, you can import your own functions to this library. Just right click on the equation sheet in the project tree that contains the function(s) you want to add to the library and select the option **Add to predefined functions**.

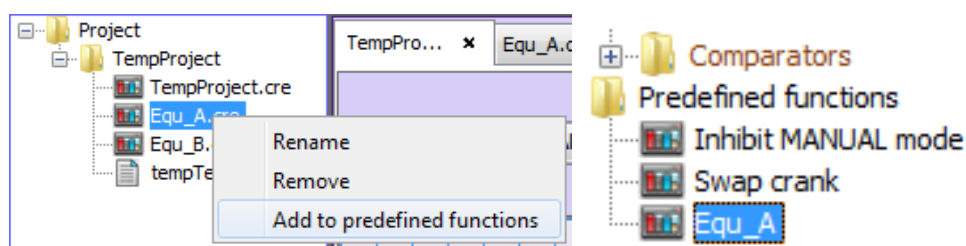

FIGURE 36: ADD A FUNCTION TO THE LIBRARY

It's interesting to add your own functions to the library because you can re-use them in future projects without having to re-draw the equations or find them among your older projects. You just need to get your function from the library by double clicking it and the corresponding equation sheet will be added to your project.

2/ Functions description

Find below a description of available functions.

Note that some of them are using user parameters/variables and logical/analog inputs or outputs. To prevent any conflict, verify that they are not used anywhere else when including a function to your project.

Fixed load management

This function allows you to apply a fixed kW setpoint when a logical input is activated on the GENSYS2.0 (only the engine related to this GENSYS2.0 will switch in this mode, others will still remain in load sharing). This setpoint can be driven by a potentiometer or a user parameter.

Settings:

- Set a GENSYS2.0 logical input function as "Select Pnom2" (E2513) using CREConfig software.
- The user parameter E1711 (connected on S input of the multiplexer) allows to select the setpoint with a potentiometer (E1711 = 0) or a parameter (E1711 = 1). In this last case, E1710 value should be set to the desired setpoint.
- In the case of using a potentiometer, the analog input spare 1 is used (E0031). Calibrate it using CREConfig software.

Fuel tank management

This function allows you to trigger an automatic filling of the fuel tank when the fuel level is below a certain threshold (E4086). Once this threshold is reached, the valve is opened and the pump is activated. When the high fuel level (E4087) is reached, the pump is stopped and the valve is closed.

Settings:

- In the equation sheet, set the first constant in the top left corner which allows you to select the analog input for the fuel level sensor:
 - ♦ 1 = analog input spare 1
 - ♦ 2 = analog input spare 2

In both cases, calibrate the analog input chosen using CREConfig software.

- Adjust fuel level values X4086 and X4087 to your needs (20 and 85 by default. Here, we supposed thresholds are in percent. It could be in liters or anything).
- The “Delay comparator” block adds a delay between the valve and pump activation. Adjust it to your needs.
- The valve control is done by the C1 output (X2020) and C2 output (X2021) is used for the pump control.
Set these output as “Used by equations” using CREConfig software.
- Note that the user variable E2440 and E2441 are used.

Force auto mode

This function allows you to force the GENSYS2.0 in auto mode (test/semi-auto and manual mode are inhibited) when a logical input is activated.

Note that this function is only valid in a single engine power plant.

Settings:

- Set logical input J6 function as “Used by equations” using CREConfig software.

Start in auto mode

This function allows you to switch GENSYS2.0 in auto mode when it is powered up.

Settings:

- Note that the user variable E2448 is used.

Switch to manual on GE fault

This function allows you to switch GENSYS2.0 in manual mode when a generator fault occurs. Manual mode will be kept forced until the fault is acknowledged and reinitialized.

Defaults triggering a hard/soft shutdown action are considered as generator fault.

Gas sequence

This function allows you to do the following start sequence:

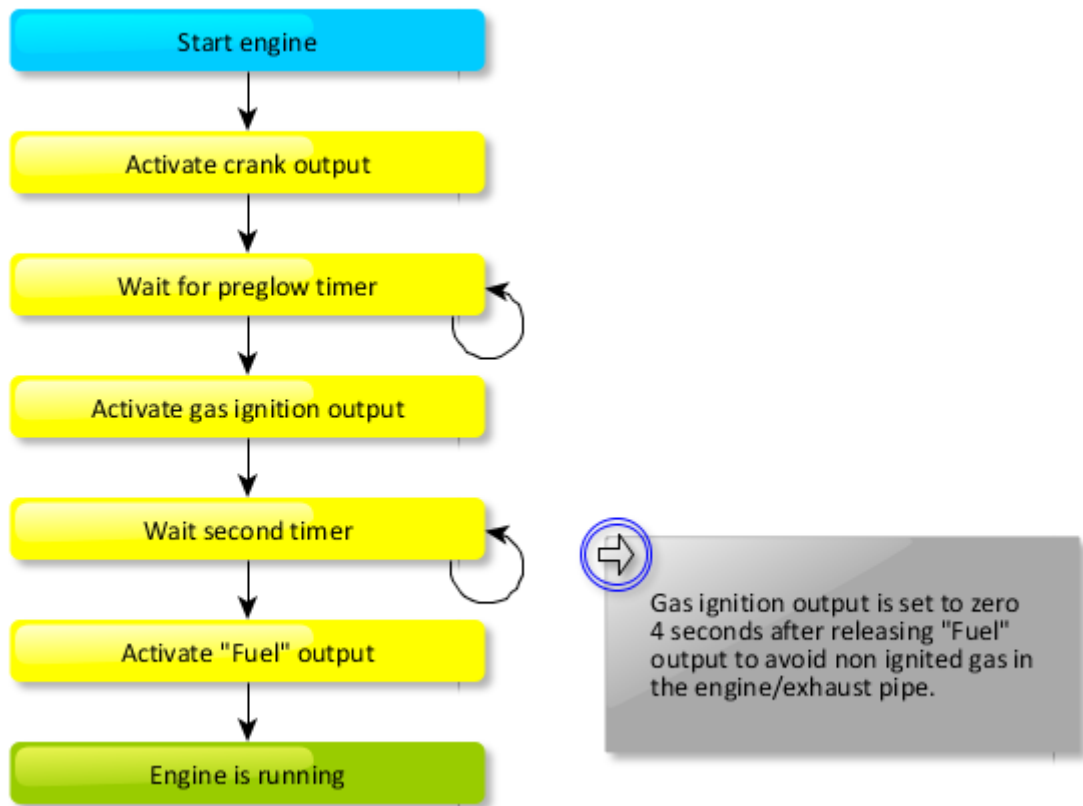

TABLE 13: STARTING GAS SEQUENCE

Settings:

- Set A1 output function to “Crank” and A2 and C1 output function to “Used by equations” using CREConfig software.
- Set user parameters E1712 (preglow timer), E1713 (second timer) and E1714 (timer to release gas ignition output when “Fuel” output is set to 0).
- Note that user variables E2442 to E2447 are used.

Link CANopen logical inputs and GENSYS2.0 virtual inputs together

These functions allow you to link the logical inputs of a CANopen module and the virtual inputs of the GENSYS2.0 together 8 by 8 (this function is for GENSYS2.0 modules version 4.66a5 and previous).

Settings:

- Set CANopen messages using CREConfig software.
- Set virtual inputs using CREConfig software.

Alternate sequence to manage multiple cranks (Swap crank)

This function allows you to modify the default crank selection sequence during the starting sequence in the case of 2 cranks:

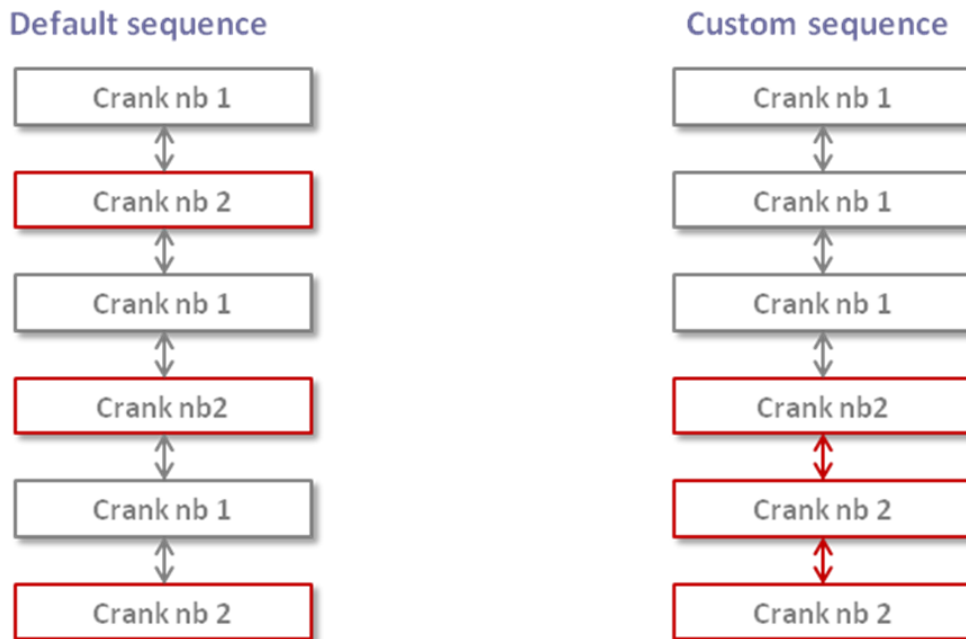

TABLE 14: CUSTOM CRANK SELECTION SEQUENCE

Settings:

- In the equation sheet, set the first constant in the top left corner (6 by default). It is the total number of start attempts. This number will be divided by 2 to share attempts between both cranks.
- The logical input J15 (E2815) is used to select the crank order. It is possible to replace it by a user variable/parameter. Set this input function as "Used by equations" using CREConfig software.
- The C1 output (X1260) is used for the second crank.
- Note that the user variable E2449 is used.

7.5 TEXT FILES

Text files can be added to an **Easy plc**'s project. They are useful to simply add content that isn't doable with the software or to add complements to the result of the compilation of the equation sheets.

Warning, equations generated during the compilation are formed like this: equations from equation sheets + equation from text files. This means that if a text file is above an equation sheet in the tree project, the Equations it contains will ne be placed before the equations from the equation sheet which is below during the compilation.

The final text file generated by **Easy PLC** is included in the project. It's also defined as the main text file for this project (the equations that this file contains will not be added to the result of the compilation).

It's easy to see which file is the main equation sheet in the tree project because of its icon which is the same as the one from the compile button:

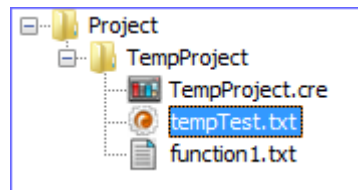

FIGURE 37: MAIN EQUATION SHEET

This file isn't editable from the software. If you edit it (by using the notepad for example) and then you compile your project, the change you made to the file will be erased. It's preferable to add a new text file to the project that contains what you want to add (remember to position the file at right place in the project tree).

If you want to modify the main text file of a project for any reasons, please make a copy of it modify this one.

It's possible to change the main text file of a project by right clicking on it in the project tree and then select **Properties** in the contextual menu that shown (see chapters 7.1).

If there is no main text file defined (e.g. this is the case when you compile your project for the first), the text file you select when saving the result of the compilation will automatically be set as main text file for this project.

8 COMPILING A PROJECT

Once all equations are designed, project must be compiled to get the final file that will be used by your target module. Compilation process is started using menu **File/Compile** or **CTRL+F5** or using the dedicated button on the toolbar as shown below.

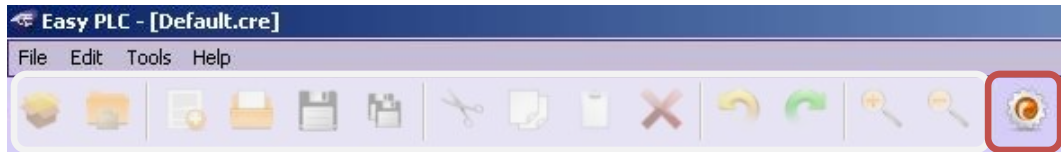

FIGURE 38: COMPILATION BUTTON

Before compilation is launched, **Easy PLC** will save the complete project and equation sheets. You may be asked for a project name if the project was never saved before. Then project will be checked for eventual errors such as missing connections or missing internal block parameters. Compilation result is shown in the status bar at the bottom of **Easy PLC** main window.

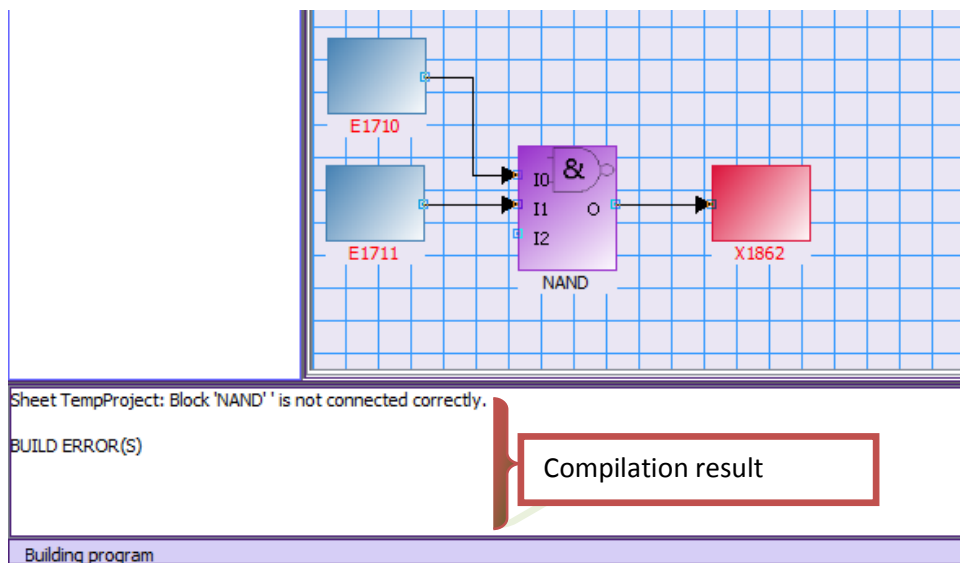

FIGURE 39: COMPILATION ERROR

When the project is successfully compiled, a dialog box opens up so you can save the resulting TXT file in your computer. This TXT file can now be sent into your target module: refer to your CRE Technology module's technical documentation to do so.

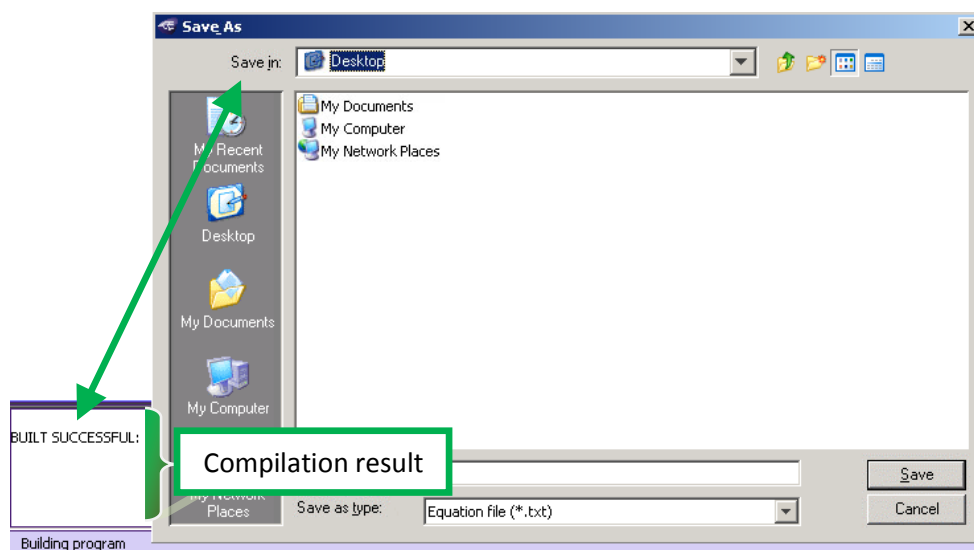

FIGURE 40: PROJECT SUCCESSFULLY COMPILED

8.1 FURTHER INFORMATION

Below are some advices to help you make sure your equations work fine in your CRE Technology product (GENSYS 2.0/MASTER 2.0 families). This list is not complete: refer to the technical documentation of your product or contact CRE Technology or your local distributor for technical support and advanced training courses.

- 1) Check variables used as internal operator variables to make sure you do not use the same variables in different operators.
- 2) As far as possible, test your equations one at a time in your module rather than loading a complex project at once: it will be easier for you to fine tune each equation and make sure it works as expected.
- 3) Do not write into any parameter or variable if you are not sure of the way to use it!
- 4) If your equations use physical logic inputs (J terminals) or logic outputs (C terminal), these inputs/outputs are automatically set as “used by equation” by **Easy PLC**.
- 5) If you use equations to modify configuration parameters of your module (Parameters E1nnn/X1nnn, E4nnn/X4nnn these parameters are set as Write enable (Read/Write) by **Easy PLC** so your equations can effectively write into them through the **PARTIAL PARAMETERS** section of your text file. The content of this section is added by your product to the **PARAMETERS** section. This allows you to write in variables without deleting all the content of the **PARAMETERS** section (for further information, please contact CRE Technology).

9 SENDING COMPILED EQUATIONS

Once your project is compiled, you are supposed to have saved the resulting text file which contains all the equations intended for the product (if you got no error during the compilation). You can now send this file directly to the module without using any other software:

Start sending file by pressing **Send file** button in the toolbar as shown in the following figure.



FIGURE 41: SEND FILE BUTTON

A configuration window opens:

- Fill in all fields to be able to start sending.
- If one of the fields isn't filled in or any error occurs during the connection or when the file is being sent, an error describing what happened is displayed.

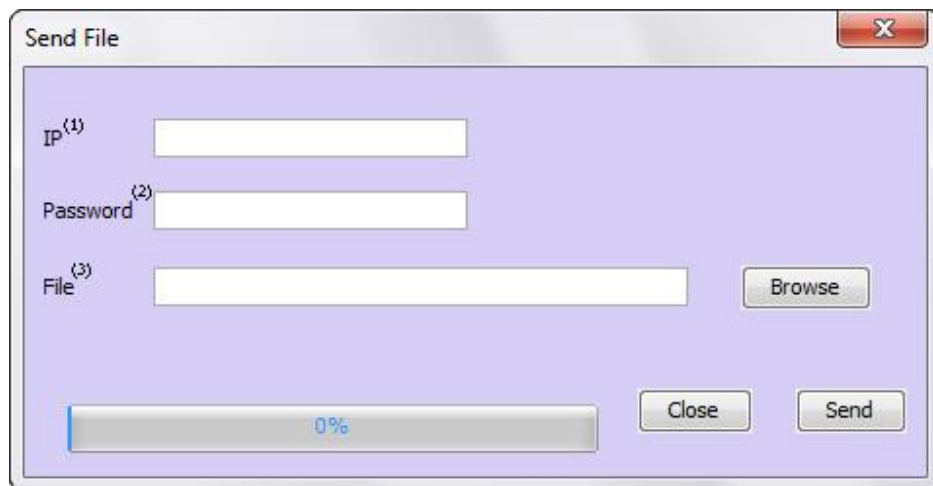

FIGURE 42: CONFIGURATION WINDOW

- (1) IP address of the product. If you don't know how to get it, please refer to manuals A53Z090020 and/or A53Z090014. If the IP address is false or the product is not connected, an error is displayed.
- (2) User password. *I.e.* the password you use to log into the module's web site or with **CRE Config** software (level 1 or level 2 password). Obviously you need to use a password according to the level of equations you are using in your project. If the password is false, an error is displayed.
- (3) The file containing the equations.

Note:

Use "Browse" button to specify the path of the text file you want to send to the module.

Once all the fields are filled, click on the **Send** button to send the file to the target. You will get this message:

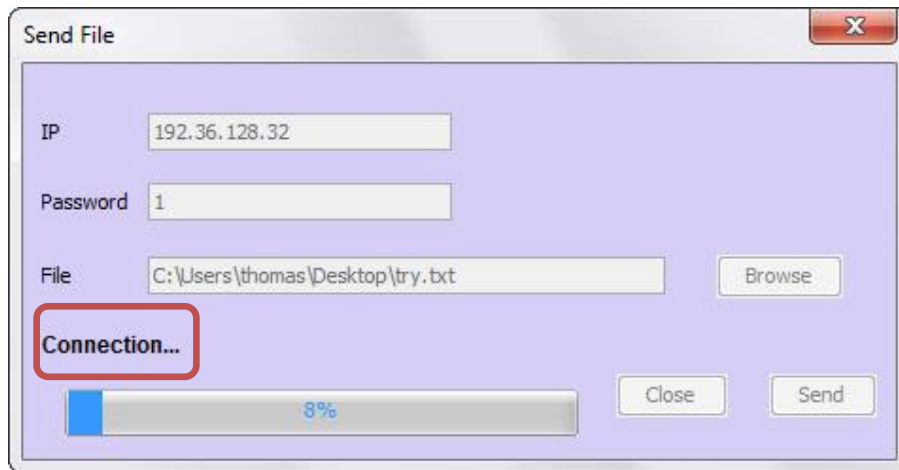

FIGURE 43: CONNECTION

The file transfer starts when the connection to the product is established. A message saying that the download of the file started is displayed. This action can take several minutes (1 or 2 minutes in general).

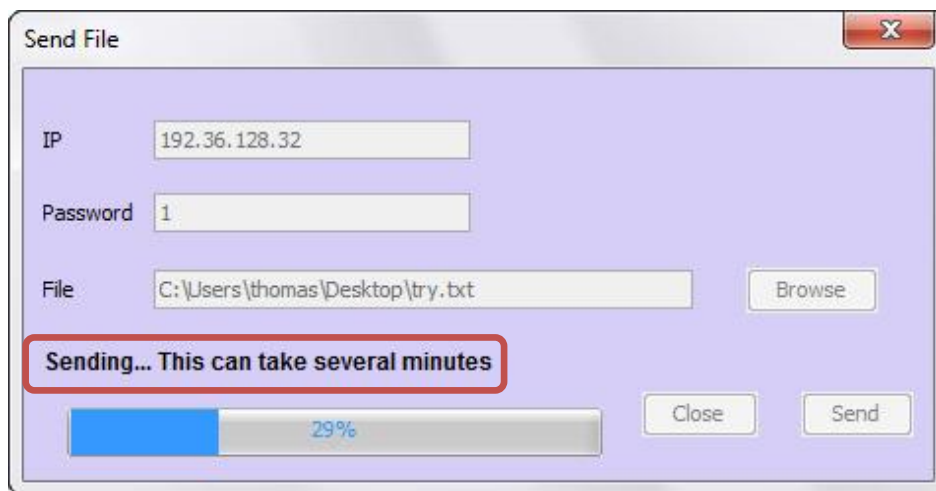

FIGURE 44: SENDING

Finally, an information window displays the free memory when the file is received.

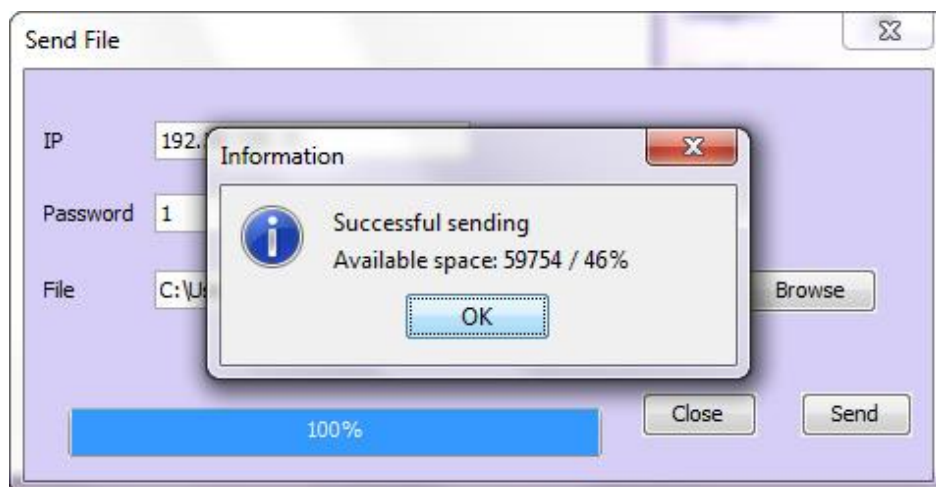

FIGURE 45: SUCCESSFUL SENDING

Now you can close both windows. Note that you don't need to restart your product when you send equations in it.

10 CRE TECHNOLOGY



130, Allée Victor Naudin
Zone des Templiers
Sophia-Antipolis
06410 Biot
FRANCE



Phone: +33 (0)4 92 38 86 82

Fax: +33 (0)4 92 38 86 83

Website: www.cretechnology.com



Email: info@cretechnology.com



Technical support: +33 (0)4 92 38 86 86 (office hours: 8.30AM-12AM / 2PM-6PM GMT+1).

Email: support@cretechnology.com



SKYPE: support-cretechnology.com

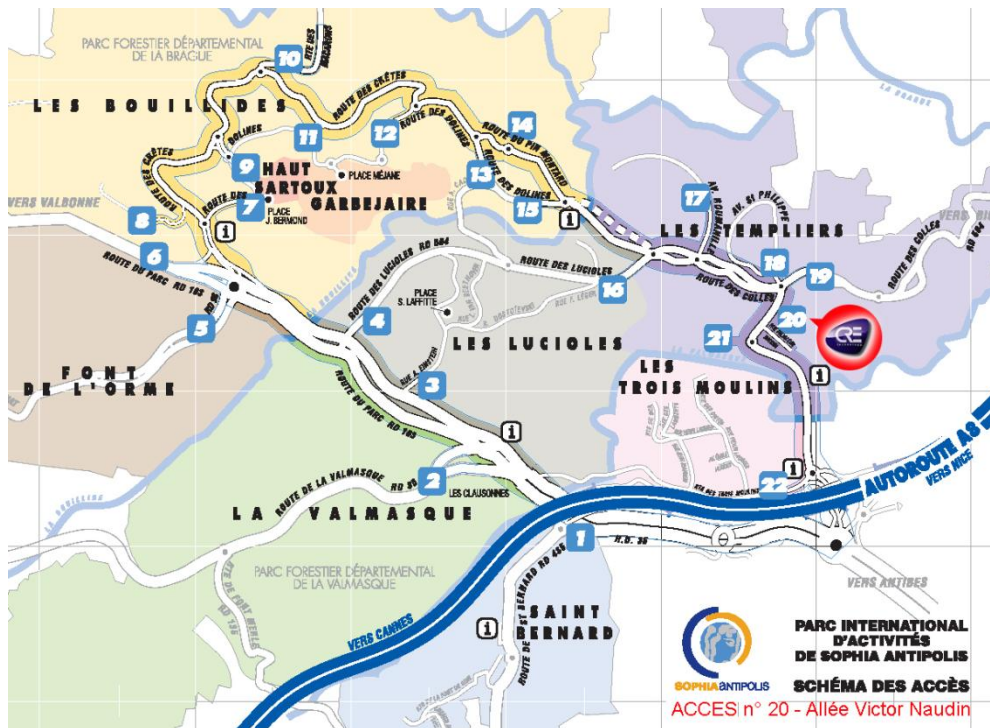

FIGURE 46: ACCESS TO CRE TECHNOLOGY

Check our entire distributors list around the world on www.cretechnology.com tab "DISTRIBUTORS"



FIGURE 47: CRE TECHNOLOGY DISTRIBUTORS

CRE Technology retains all copyrights in any text, graphic images, and software owned by CRE Technology and hereby authorizes you to electronically copy documents published herein solely for the purpose of transmitting or viewing the information.

© copyright
all rights reserved