

“

*Renewable  
energy at the  
heart of your  
production  
plants*

”

The logo for CRE TECHNOLOGY, featuring the letters 'CRE' in a large, bold, stylized font, with the word 'technology' in a smaller, lowercase font below it. The logo is set against a white background within a dark blue diamond shape.

**CRE**  
technology

The background is a collage of images related to renewable energy and industrial control. It includes a close-up of a green industrial motor, a large array of solar panels under a blue sky with clouds, and a close-up of a control panel with buttons labeled 'ENTER', 'OPEN', and 'CLOSE'. The collage is overlaid with a grid of dark blue and grey diamond shapes.

# RENEWABLE & HYBRID POWER PLANTS CONTROL SOLUTIONS

## **Optimal Management of Renewable & Hybrid Power Plants with CRE TECHNOLOGY Controllers**

CRE TECHNOLOGY has innovated a specialized range of products designed for the efficient management of renewable energy sources integrated with generators and/or grid systems. Our COMPACT controllers, coupled with the i4Gen color touchscreen Human-Machine Interface (HMI), present the most effective solution to meet all your hybrid power plant requirements. Our COMPACT controllers come equipped with a host of essential functions and protections for hybrid plant control, all native to the system and requiring

only straightforward configuration. These controllers not only provide hardware I/O expansion but also offer extensive programming capabilities to handle additional sequences. Key to our offering, the COMPACT controllers boast robust communication features, facilitating control via an external centralized Programmable Logic Controller (PLC) or Energy Management System (EMS). Standard features include ModBus TCP read/write capabilities (RTU available as an option). Additionally, any sequences or functions to be managed by the PLC or EMS can be selectively deactivated in the COMPACT controllers, ensuring flexible and tailored control solu-

# RENEWABLE & HYBRID CONTROLLERS RANGE

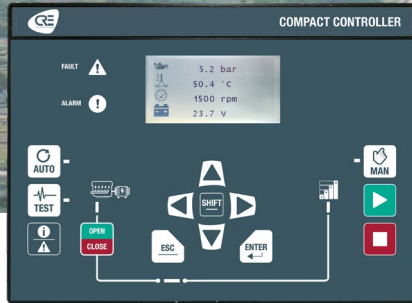

**GENSYS COMPACT PRIME**  
ADVANCED GENERATORS CONTROLLER

The GENSYS COMPACT PRIME is a sophisticated generator controller designed to operational efficiency. This controller offers a comprehensive suite of features:

- **Automated Engine Start & Stop Sequences:** Simplifies the process of initiating and ceasing generator operation.
- **J1939 CANbus Communication:** Ensures integration with electronic engines, enhancing performance monitoring and control.
- **Generator Protections:** Includes both mechanical and electrical safeguards to ensure reliable and safe operation.
- **Parameters Monitoring and Display:** Easy control and display of mechanical and electrical parameters.
- **Synchronization Capability:** Allows the synchronization of up to 32 generators (with grid, batteries, PV, wind...), ensuring cohesive operation and energy distribution.
- **kW/kVAR Load Sharing:** Features load/unload ramp transfer for optimal load management.
- **Dynamic Generator Management:** Adjusts the number of generators in operation based on load variations and photovoltaic or wind power production changes. This is achieved through its advanced CANbus communication with other hybrid controllers, ensuring a steady reserve power supply.

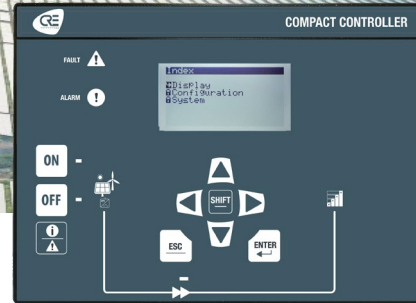
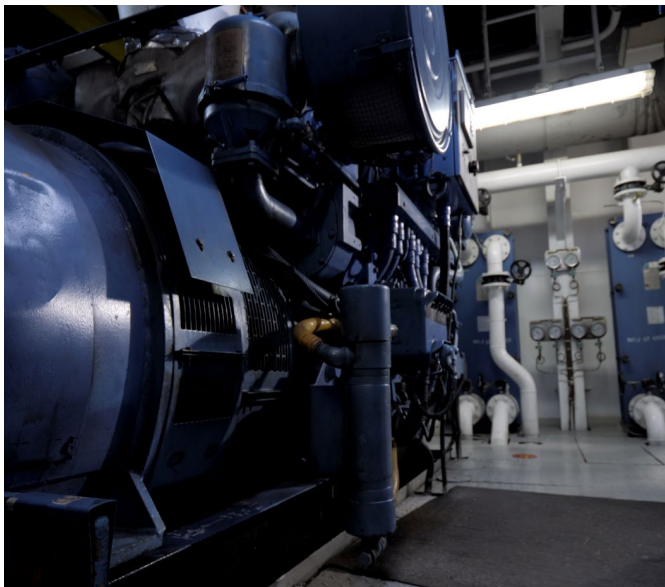

**HYBRID COMPACT**  
ADVANCED PV/WIND TURBINE INVERTERS CONTROLLER

The HYBRID COMPACT is a specialized controller for photovoltaic and wind turbines inverters, offering comprehensive control and monitoring features:

- **Flexible Inverter Control:** Capable of managing either a single photovoltaic or wind turbine inverter or multiple inverters via a proprietary centralizing device.
- **Broad Communication Compatibility:** Supports ModBus TCP & RTU communication (with adapter for RTU) with a wide range of inverters including brands like ABB, Afore, AP Systems, Canadian Solar, Danfoss Solar, Delta, Deye, Fronius, Goodwe, Hoymiles, Huawei, Kaco, Outback Power, Qcells, Schneider, Solax Power, Solis, Sungrow...
  - > For Sunspec compatible inverters, the controller offers automatic recognition without the need for ModBus table configuration.
  - > For non-Sunspec inverters, a configurable ModBus table is available.
- **Parameters Monitoring and Display:** Enables the acquisition and display of the inverter's electrical parameters, either via ModBus TCP/RTU or using the product's own voltage and current inputs for redundancy and accelerated data acquisition.
- **Photovoltaic and wind Power Limitation Management:** Adjusts photovoltaic or wind power based on application needs, such as maintaining minimum power on generators, complying with grid setpoints, or limiting batteries charging current.
- **Reactive Power Control:** Allows the control of photovoltaic or wind reactive power, either through a configurable fixed power factor or by sharing reactive power between photovoltaic or wind inverter and other sources.
- **Safety Features:**
  - > Immediate shutdown of photovoltaic or wind production in the event of reverse power to the generators, in order to maintain production.
  - > Includes manual control of the inverter production relay.
- **Communication Loss Management:**
  - In the event of communication loss with the inverter:
    - > The controller can open the inverter production relay
    - > Or switches the generators to droop mode to ensure continued operation, reverting to isochronous mode once communication is restored
- **Inverter Electrical Protection:** Ensures the safety and longevity of the inverters.

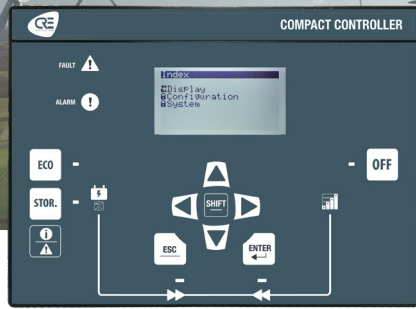

## BAT COMPACT ADVANCED STORAGE BATTERY INVERTERS CONTROLLER

The BAT COMPACT is a state-of-the-art controller for storage battery inverters, offering a wide range of functionalities:

- **Flexible Inverter Control:** Capable of managing a single storage battery inverter or multiple inverters through a proprietary centralizing device.
- **Extensive Communication Compatibility:** Features ModBus TCP and RTU communication (with adapter for RTU) compatible with most inverters in the market. Includes a configurable ModBus table to facilitate adaptation to each inverter model.
- **Parameters Monitoring and Display:** Enables the acquisition and display of inverter's electrical parameters, either via Modbus TCP/RTU or using the product's own voltage and current inputs for redundancy and accelerated data acquisition.
- **Advanced Battery Power Management:**
  - > Allows batteries to be used in grid forming, with generator management in P/Q mode (base load) to control battery current.
  - > Allows batteries to be used in grid following, with generator management in U/F mode to effectively absorb load impacts.
- **Reactive Power Control of Batteries:** Allows the control of the batteries reactive power, either through a configurable fixed power factor or by sharing the reactive power between the batteries and other sources.
- **Customizable Algorithms:** Offers predefined algorithms that can be easily tailored by modifying a few parameters, optimizing production and integrating power plant constraints.
- **Dynamic Start/Stop of Generators:** Triggered by various factors such as battery State of Charge (SOC), reserve power of batteries and generators, fluctuating renewable energy active power, and communication faults with the battery inverter.
- **Manual and Automated Inverter Control:** Includes manual control of the inverter production relay, along with automated responses to communication loss with the inverter, such as opening the inverter production relay or switching the generators to droop mode.
- **Electrical Protection:** Ensures the safety and longevity of both the inverter and batteries



**Need Assistance with your configuration?  
Our expert team is ready to assist you. Contact  
us for support with configuring your application:**

info@cretechnology.com  
+33 (0)4 92 38 86 82

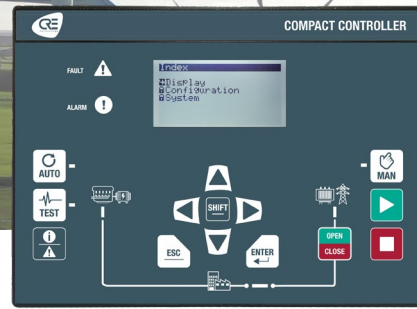

## MASTER COMPACT 1B ADVANCED GRID CONTROLLER

The MASTER COMPACT 1B is designed to provide comprehensive control and monitoring for grid systems with the following capabilities

- **Parameters Monitoring and Display:** Enables the acquisition and display of essential grid electrical parameters, ensuring in-depth control
- **Grid Decoupling Protections:** Manages all necessary protections against grid decoupling and loss of mains, ensuring system integrity.
- **Synchronization:** Facilitates synchronization between generators, batteries, and grid, ensuring smooth operation and transition.
- **Active & Reactive Power Regulation:** Offers regulation according to various operating modes, including base load and peak shaving, adapting to different power management.
- **Efficient Import/Export Active Power Management:** Manages the import and export of active power from generators and photovoltaic or wind systems to the grid, optimizing energy usage and distribution.
- **Black Start Capability:** Designed to handle black start situations, ensuring the power system's ability to recover from a total or partial shutdown.

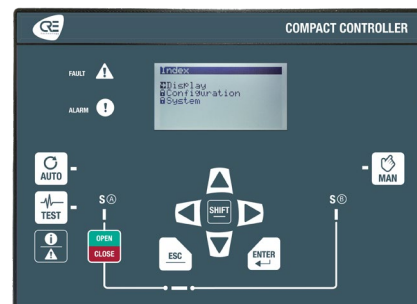

## BTB COMPACT ADVANCED TIE-BREAKERS CONTROLLER

The BTB COMPACT is an innovative controller designed for efficient management of tie-breakers in power systems, offering the following features:

- **Parameters Monitoring and Display:** Facilitates the acquisition and display of electrical parameters for both Source A and Source B, ensuring detailed oversight of power conditions.
- **Efficient Synchronization:** Capable of synchronizing two separate power sources on bus bars through a tie-breaker.
- **Load Transfer Management:** Expertly handles kW and kVAR load transfer ramps, enabling effective management of power flow and load balancing.
- **Intelligent Power Plant Segment Management:** Automates the decision-making process regarding inter-controller communication. This is based on the position of the tie-breakers, ensuring optimal coordination across different segments of the power plant.



## Enhanced Features of all COMPACT Controllers

All the COMPACT controllers offer a range of advanced functionalities to suit various installation and operational requirements:

- **Versatile Design Options:**
  - > «HMI Version» suitable for front panel mounting, providing direct user interface.
  - > «CORE Version» designed without front HMI for DIN Rail mounting inside panels, offering flexibility in installation.
- **Proprietary CANbus Communication:** Facilitates data exchange and control decisions between all Compact Controllers, such as start/stop of generators and active and reactive power management.
- **Ethernet Communication:** Supports optional i4Gen color and touchscreen HMI for centralized power plant configuration, display, and control, enhancing user interaction and oversight.
- **Advanced ModBus TCP Capabilities:** Offers master and slave ModBus TCP communication (with RTU as an option). It allows the creation of custom ModBus frames (read & write) in addition to standard product capabilities, catering to specific requirements.
- **Programmable Agenda Feature:** Enables the management of periodic actions on a daily, weekly, or monthly basis, adding to operational convenience.
- **User-Friendly Programming System:** Designed to cover simple needs, ensuring ease of use programming.
- **Input/Output Extension:** Includes analog inputs, digital inputs, and digital outputs as standard features, providing extensive connectivity options.
- **Remote Access and Control:** Offers full remote display, configuration, and control of the entire power plant through a secure cloud application. This application features two-factor authentication and SSL certification, accessible via PC or smartphone, ensuring secure and convenient remote management.



# OUR PRODUCTS COVER ALL RENEWABLE & HYBRID APPLICATIONS



## ON GRID BESS APPLICATION

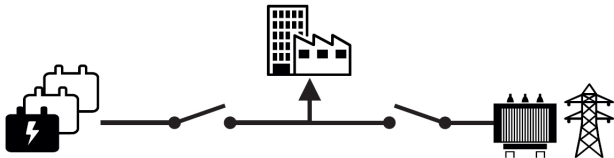

## ON GRID PV/WIND APPLICATION

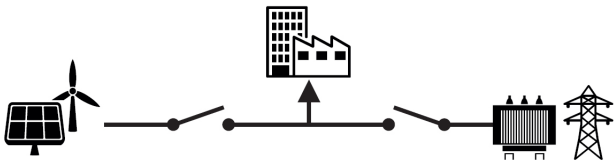

## OFFGRID RENEWABLE APPLICATION

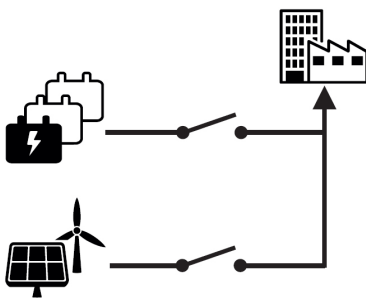

## ON GRID RENEWABLE APPLICATION

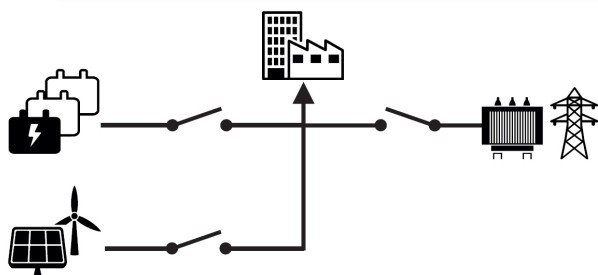

## OFF GRID HYBRID/MICROGRID APPLICATION

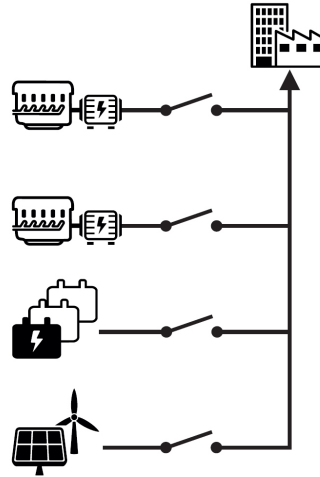

## ON GRID HYBRID/MICROGRID APPLICATION

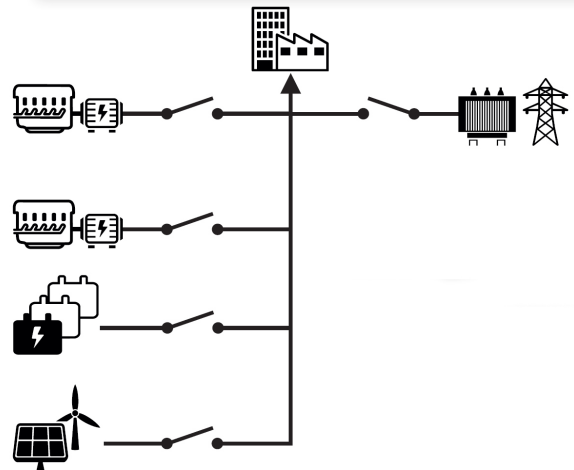

You need more technical information on our products?

Download our documentations  
now on [www.cretechnology.com](http://www.cretechnology.com)



“

**Our renewable & hybrid solutions are designed to enhance the reliability, flexibility, and performance of your energy management**

”

### Single Line Diagram: Automatically Generated for Comprehensive Plant Visualization

- **Global Plant Visualization:** This feature automatically generates a single line diagram based on the configuration of all controllers, providing a complete and clear overview of the entire plant's layout and operation.

- **Selective Source Visualization and Control:** Enables users to select any source within the plant for detailed visualization. This selection allows the visualization, configuration, programming, and of all parameters associated with the chosen controller.

### Enhanced Monitoring with Production Curves & Load Profiles of Energy Sources

- **Flexible Display**
  - > «Separate Mode»: Allows the individual display of production curves and load profiles for each energy source, facilitating focused analysis.
  - > «Superimposed Mode»: Offers a combined view where production curves and load profiles are overlaid. This mode is particularly useful for visualizing and comparing the load across different energy sources.

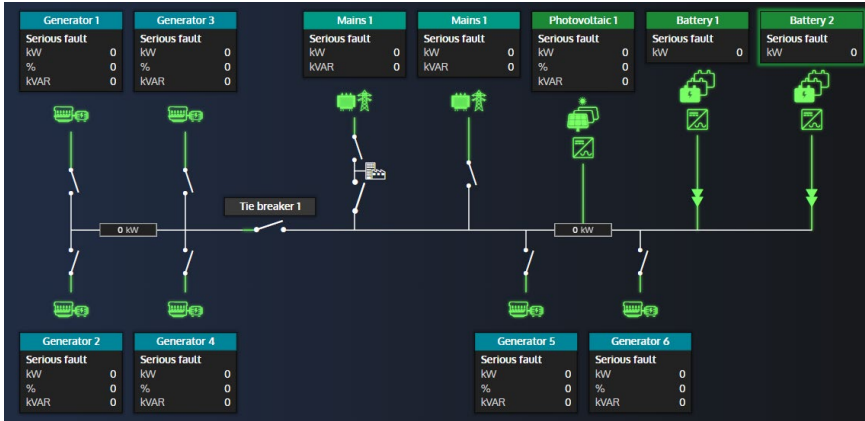

**FIND ALL OUR PRODUCTS AND SERVICES ON OUR WEBSITE AND OUR SOCIAL NETWORKS**

**WWW.CRETECHNOLOGY.COM**

