



TECHNICAL DOCUMENTATION SYNCHRO COMPACT



CRE TECHNOLOGY
130, allée Charles-Victor Naudin
Zone des Templiers - SOPHIA ANTIPOLIS
06410 BIOT - FRANCE
Phone: + 33 (0)4 .92.38.86.82
www.cretechnology.com
info@cretechnology.com

COPYRIGHT © CRE TECHNOLOGY. ALL RIGHTS RESERVED.

TABLE OF CONTENTS

DESCRIPTION	3
Front Face	3
Rear Face	6
Panel Mounting	7
UL Requirements	9
USAGE	11
Password	11
LCD	12
Wiring	14
Digital Inputs	21
Digital Outputs	23
Analog Inputs	24
Hysteresis DI	27
Hysteresis AI	28
SETTINGS	29
Speed/Voltage Control	29
Synchronization	32
Protections	36
Control Loop PID	38
ADVANCED FUNCTIONS	39
Modbus TCP Mapping	39
Logger	40
COMMUNICATIONS	41
Network	41
Modbus TCP/IP	43
CRE-Link®	46
CANopen	47
SAE J1939	48
CAN bus Good Practices	55
WEBSITE	57
Access	57
File Transfer	58
Firmware Update	60
APPENDICES	61
ECU J1939	61
Troubleshooting	71
Standards for Generator	75
Certifications	76
Software Variables	79

DESCRIPTION

FRONT FACE

SYNCHRO COMPACT

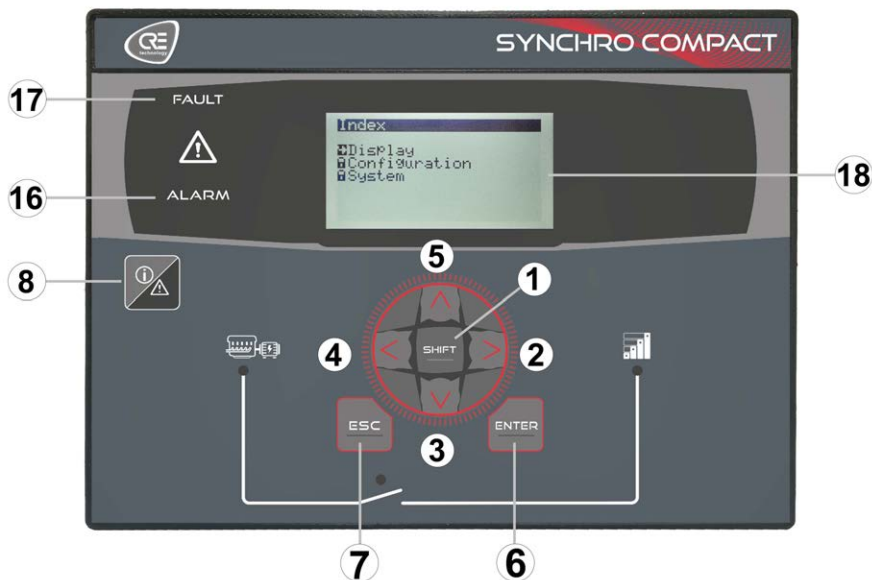

PIN	Buttons	Functions
1	SHIFT button	Additional functions.
2	RIGHT button	Navigation button (Right).
3	DOWN button	Navigation button (Down).
4	LEFT button	Navigation button (Left).
5	UP button	Navigation button (Up).
6	ENTER button	Validating entry / MENU .
7	ESC button	Cancel entry / escape MENU .
8	INFO button	Allows direct access to the current Fault or Alarm display.
g ⁽¹⁾	Generator circuit breaker button	Can only be used in MAN mode. Generator circuit breaker control. Press to Open. Press to Close (synchronization & load transfer will be done automatically if Bus is powered & configuration is setup for paralleling operation).
10 ⁽¹⁾	Bus circuit breaker button	Can only be used in MAN mode. Bus circuit breaker control. Press to Open. Press to Close (synchronization & load transfer will be done automatically if Bus is powered & configuration is setup for















TECHNICAL DOCUMENTATION

PIN	Buttons	Functions
		paralleling operation).
11 ⁽¹⁾	STOP button	Can only be used in MAN mode. Stop the Generator. Pressing once this button will set the Generator offload and initiate cooling down sequence.
12 ⁽¹⁾	START button	Can only be used in MAN mode. Start the Generator.
13 ⁽¹⁾	MAN button	MAN mode. The associated LED lights up when the mode is activated.
14 ⁽¹⁾	TEST button	TEST mode. The associated LED lights up if the mode is activated.
15 ⁽¹⁾	AUTO button	AUTO mode. The associated LED lights up when the mode is activated.
16	ALARM indicator	The LED flashes when an alarm appears. The LED is lit when an alarm is acknowledged, but not reseted.
17	DEFAULT indicator	The LED flashes when a Fault occurs. The LED is lit when a Fault is acknowledged, but not reseted.
18	LCD display	Screen size: 40mm x 70mm; Back-light : typical 50cd/m ² , configurable. Type: STN; 64 x 128 pixels.

⁽¹⁾ Not available according to controller type.

Note: Pressing the button **STOP** twice will set the Generator offload and stop the engine without cooling down sequence.

NAVIGATION KEYS

Keys	Navigation mode	Edition mode
 	Scrolling menus.	Modifying parameters values once selected: When up/down keys are used to modify values, holding the key will accelerate the entry scrolling.
 	Navigating right/left in display.	NA
	 +   will increase/decrease the brightness of the LCD display.  +   will increase/decrease the contrast of the LCD display.	In MAN mode, when the Generator is offload, use   to increase/decrease: <ul style="list-style-type: none"> ▪ The speed when the "Speed governor control" page is displayed. ▪ The voltage when the "AVR control" page is displayed. <p><i>Note: Not available on MASTER COMPACT, MASTER COMPACT 1B and BTB COMPACT.</i></p>
	Return to previous menu.	Cancel setting and return to Navigation mode.
	Accessing a menu / Switching to Edition mode.	Validation of the modified parameter and return to Navigation mode.







BUTTON INHIBITION

To inhibit front panel buttons, use the ***i4Gen Suite Software/System/Button inhibition*** page. This page shows the list of front panel buttons, tick the corresponding box to inhibit actions on the button.

Table below shows the 16 bits variable used for remote button inhibition by Modbus, each bit is assigned to a button:

Variable	Label	Description
[3557]	Inhibit key	Each 1-bit inhibits a front panel button.

RELATION BUTTON / INHIBITION BIT [3557]

Inhibition bit	8	7	6	5	4	3	2	1
Key								
Inhibition bit		15	14	13	12	11	10	9
Key								

EXTERNAL BUTTON REQUESTS

It is possible to remotely activate button actions by Modbus TCP, for a remote manual control for example. If a button action is controlled by Modbus TCP, the last request received (external or from the front panel) is treated in priority and cancel the previous request.

The buttons on the front panel can be replaced by external commands via digital inputs.

[Modbus TCP/IP](#)

[Modbus mapping](#)

REAR FACE

SYNCHRO COMPACT

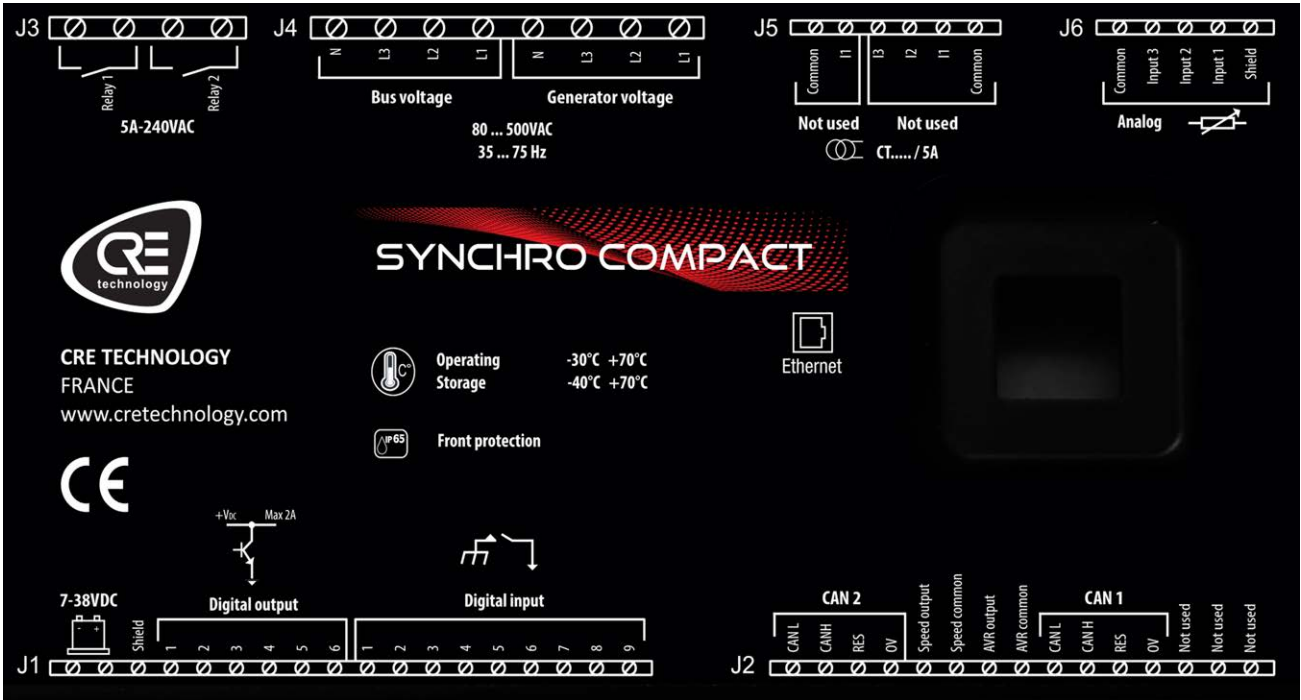

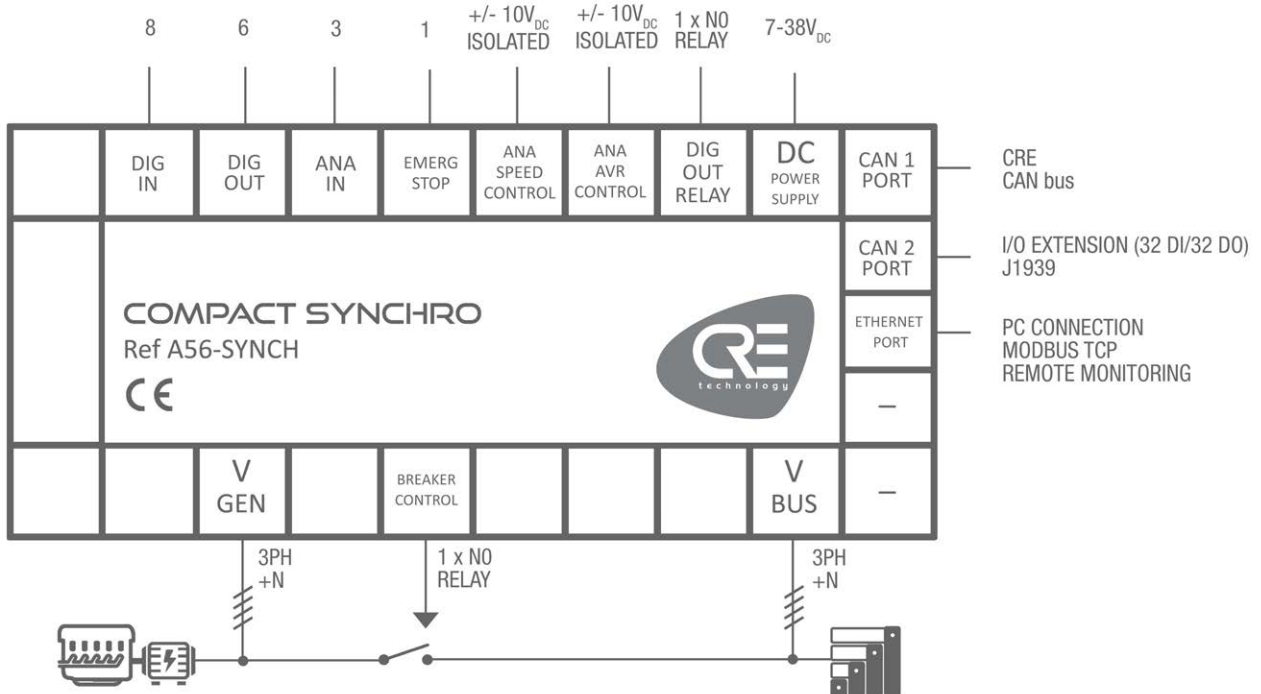

SIMPLIFIED WIRING DIAGRAM



PANEL MOUNTING

The unit is designed for panel mounting, which provides user with access only to the front panel.

  WARNING
THE UNIT IS NOT GROUNDED
<ul style="list-style-type: none"> • Take all measures against Electronic Static Discharges. • Do not try to open the unit.
Failure to follow these instructions may damage the unit.

Environmental requirements:

- Operating temperature: -20...70°C (-4...158°F); LCD display slows down a bit under -5°C (23°F). Avoid direct exposure to the sun.
- Storage temperature: -40...70°C (-40...158°F).
- Altitude: 4000m (13123ft) for a max AC voltage of 480VAC; 5000m (16404ft) for a max AC voltage of 400VAC.

UNPACKING

Make sure the packaging contains:

- The unit.
- 6 connectors.
- 1 fixing kit composed of 2 parts.
- 4 screws.
- A delivery bill.

Unpack and keep the packaging in case of return.

Make sure the unit does not show scratches or visible defaults. Otherwise describe them on the RMA sheet (available on [CRE TECHNOLOGY website](#)) and return it with the product to your distributors.

INSTALLATION

Preparation

- Torque of mounting brackets: 0.4Nm.
- Cut out the panel to 220x160mm (8.7x6.3in) minimum.
- Make sure the cut-out is smooth and clean.

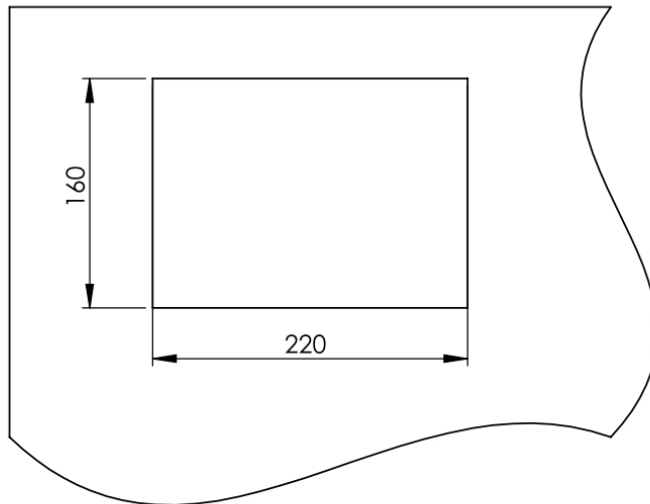

Mounting

0	Tool : cross-heas screwdriver size 1	
1	Pass the unit through the mounting surface	
2	In the rear, cover each of the four spacers using the 2 parts of the fixing kit.	
3	Screw a first corner against the mounting surface	
4	Repeat on the diagonally opposite spacer	
5	Repeat on the other diagonal and tighten equally (do not overtighten)	

UL REQUIREMENTS

CIRCUIT SEPARATION

The communication, sensor, and/or battery derived circuit conductors shall be separated and secured to maintain at least 1/4" (6mm) separation from the Generator and the Bus connected circuit conductors unless all conductors are rated 600V or greater.

OTHER CIRCUITS RATINGS

For information on circuits ratings, see chapter [Wiring](#).

MAINS RATINGS

Over-voltage Category

III, 300VAC system voltage.

Sensing Generator / Bus Voltage Measurement (J4)

300VAC max P-N, 2 phases; 500VAC P-P 3 phases, 35...75Hz.

Current Inputs (J5)

Must be connected through listed or recognized isolating current transformers with secondary rating of 5A max 50/60Hz. (XODW2.8) Instrument transformers (according to IEEE C57.13 series or the equivalent).

Communication Circuits

Must be connected to communication circuits of UL Listed equipment.

Output Pilot Duty (J3)

250VAC, 5A max general purpose, 240VAC, 1/4HP for NO contact, 1/6HP for NC contact Pilot duty: C150, C300.

Digital outputs (J1)

FET: Fuel shutoff: 63VA, 1.8A max current.

OVERCURRENT PROTECTION (DC SUPPLY AND L1, L2, L3, N)

Installer shall protect DC supply and L1, L2, L3, N by fuse Type: R/C (JDYX2/7), or R/C (JDYX2) and CSA Certified Class 1422-30.

Rating of fuses:

- DC supply to be protected by 5A, 40VDC max.
- L1, L2, L3, N, fuse protection 100mA/600VAC max.

TERMINALS WIRING

Terminal (screw type):

- Tightening Torque: 3.5lb.in (0.4Nm).

Wires :

- 28-14 AWG, Cu, 75°C min.

Conductor protection must be provided in accordance with NFPA 70, Article 240.

Low voltage circuits (35VDC or less) must be supplied from the engine starting battery or an isolated secondary circuit.

ENVIRONMENT

Device must be installed in an unventilated or filtered ventilation enclosure to maintain a pollution degree 2 environment.

Maximum surrounding air temperature rating: 45°C.

ADVANCED WIRING DIAGRAM

Wiring diagrams available on the website [CRE TECHNOLOGY](#) : **SYNCHRO COMPACT HMI _ CORE - Standard wiring schematics**

INSTALLATION

For information on installing the product, see chapter [Panel Mounting](#).

USAGE

PASSWORD

ADVICE	
	USEFUL INFORMATION
	<ul style="list-style-type: none"> ▪ Adjustment tip ▪ Using the module
	Failure to comply with these recommendations may cause the module to malfunction.

The menus will be automatically locked if no operation is performed during the time set in the **System** menu (Factory setting: 30 minutes).
The standby screen will be displayed.





The module provides secured password access to protect configuration changes and limit data accessibility:

Level	Default password	Authorization	Accessible pages and items
0	No password. Press 	By default, this level is not password protected, but you can implement one.	Display menu pages only.
1	1	User level, settings and commissioning.	Display, Configuration and System menu pages.
2	1234	Used to change advanced settings.	Advanced settings (<i>i4Gen Suite Software</i> only).

Passwords can be changed via **CRE PC** software: ***i4Gen Suite Software***

To access the **Display** menu, press .

To access the **Configuration** and **System** menus, the padlock must be released:

1. Press  to select **Configuration** or **System**.
2. Press  to switch to password input mode (as for other settings).
3. Change the character by pressing .
4. Move to the next character by pressing .
5. Repeat the operation for each character.
6. Confirm the password by pressing .

LCD

NAVIGATION

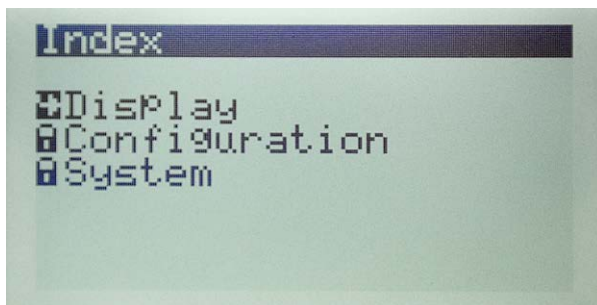

Press **ESC** , then, select the required menu, then press **ENTER** and enter the level 1 password if necessary (Configuration & System):





A black pointer spots the currently selected item/setting.

Three main menus are available on the LCD screen and in **i4Gen Suite Software**:



- **Display** gives all product measurements in real time.
- **Configuration** is used to adjust the settings done with **i4Gen Suite Software/Configuration**.
- **System** is used to adjust the system settings (Date/Hour, screen features, ...) done with **i4Gen Suite Software/System**.

To cycle through the menus and menu items, press  or .

To cycle through the pages of lists of settings, press  or .

EDITION

To change a setting:

1. Navigate to the setting.
2. Press **ENTER** to switch to **Edition** mode; the current value blinks.
3. Press  or  to get the new value.
4. Press **ENTER** to validate the new value, **ESC** to reject it. Module returns to **Navigation** mode.

It is also possible to change settings using Modbus TCP.

DEDICATED PAGES

Dedicated pages include:

- Fault : Active fault and archive pages.
- Alarm : Active alarm and archive pages.
- Information pages.

At any time, faults/alarms/information can be displayed on the LCD screen by pressing the button .

If a fault is active and has not been acknowledged yet, the active fault page will be displayed.

Otherwise, if an alarm is active and has not yet been acknowledged, the active alarms page will be displayed.

Otherwise the information page will appear.

It is then possible to navigate through these dedicated pages using the arrow buttons.



To return to the previous page, press **ESC** or .

EVENTS

Up to 15 active events and 30 archived events can be displayed on the screen.

Each event is time-stamped as follows:

jj/mm/yy hh:mn:ss protec. label On (or Off).

To reset events, press  + 

Note: Correct the condition that triggered the protection before performing a reset; if necessary, the protection will trip again.

INFORMATION

These pages allow to display the power and engine current state with the associate elapsed time in this state.

Power [4000] displays the unit current state regarding power management.

Information variables: to display any variable, enter the code of the variable to be displayed.

WIRING

Tool: insulated screwdriver Ø2.5 mm (0.1 in), tightening torque: 0.8 Nm (7 lb-in) max.

Accessories: 4, 5, 6, 8, 15 & 18-terminal cable connectors, protective gloves, carpet if the floor is wet.

 WARNING	
THE UNIT IS NOT PROTECTED	
<ul style="list-style-type: none"> • Use external fuses: <ul style="list-style-type: none"> ▪ Generator and Bus phases: 100mA/600VAC ▪ Battery positive: 5A/40VDC • Install the fuses as near as possible to the unit, in a place easily accessible to the user. 	
Failure to follow these instructions may damage the unit.	

DANGER	
	RISK OF ELECTRIC SHOCK, EXPLOSION OR ARCING
	<ul style="list-style-type: none"> ▪ The module may only be installed and maintained by qualified electricians. ▪ Use personal protective equipment (PPE) ▪ Follow good safety practices for electrical work. ▪ Turn off the power before installing or replacing a fuse, and before installing the module. ▪ Use equipment adapted to check the absence of voltage. ▪ Do not use a resettable fuse.
	Failure to follow these recommendations may result in death or serious injury.

GENERAL PROCEDURE

1. Make sure the cable connectors are not plugged.
2. Take on protective gloves.
3. Connect the wires on each cable connector in accordance with the National Wiring Regulations.
4. Plug each cable connector onto the related connector.
5. Plug a direct Ethernet cord (RJ45, male-male, 100m max., 100Ω; a crossover cable such as 3-m long A53W1 is OK as long as your switch uses auto MDI/MDIX technology or if the link to PC is direct) and lock the rear door.

RECOMMENDATIONS

Wires section: 2.5mm² (AWG13).

To avoid ElectroMagnetic Interferences, shield cables appropriately; for CAN bus, see [CAN bus good practices](#).

Isolation : keep the power cable separate from the CAN bus cables. The latter can be installed in the same duct as the low level I/O wires (under 10V DC).

If power and communication cables have to cross each other, do it at right angles to avoid crosstalk:

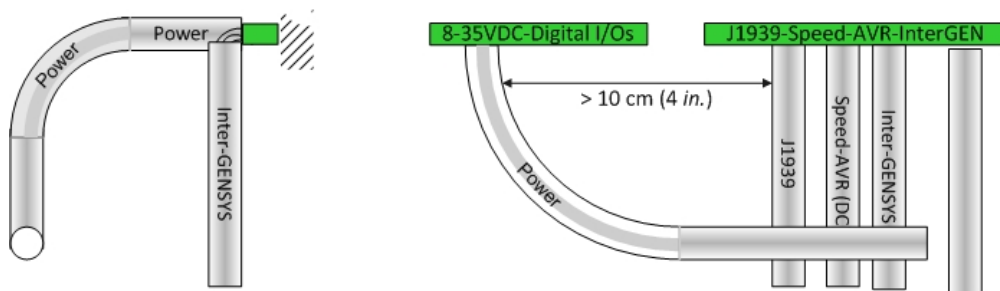

Wiring diagrams available on the website [CRE TECHNOLOGY](#) : **SYNCHRO COMPACT HMI _ CORE -**

Standard wiring schematics

UPPER BLOCKS

DANGER	
	EXPOSED TERMINALS
	Do not touch L1, L2, L3 terminals nor use non-insulated tools near them. These terminals are unprotected and will expose the user to dangerous voltages.
	Failure to follow this instruction may result in death, serious injury or equipment damage.

Block and mark	Description	Note
Breaker commands		Normally open. Breaking capacity: 5A, 240VAC.
Relay 1	Relay 1 +	
	Relay 1 –	
Relay 2	Relay 2 +	
	Relay 2 –	
AC voltage ⁽¹⁾		100...480VAC, 35...75Hz, 100mAmax; accuracy: 1% fsd.
N	Generator N	Optional.
L3	Generator L3	These lines must be protected externally with 100mA/600VAC fuses.
L2	Generator L2	
L1	Generator L1	
N	Bus N	Optional.
L3	Bus 3	These lines must be protected externally with 100mA/600VAC fuses.
L2	Bus 2	
L1	Bus 1	
Current inputs⁽¹⁾		Short-circuit protection available.
Bus common	GND	Connect to the ground.
Bus current I1	Bus I1	0...5A. Maximum rating: 15Aduring 10s. <ul style="list-style-type: none"> ● Burden: 1VA. Keep the lead length short to preserve accuracy (up to 0.5% full scale deviation). ● The maximum of the external CT ratio is 3250 (i.e. 3250:1 or, preferably, 16250:5). ● On GENSYS COMPACT PRIME, this input must be used only for the earth fault protection. ● On GENSYS COMPACT MAINS and AMF COMPACT, if Mains power measurement is configured as "mA" or "Unused", this input can be used as an earth current measurement.

TECHNICAL DOCUMENTATION

Block and mark	Description	Note
Generator current I3	Generator I3	0...5A. Maximum rating: 15A during 10s. • Burden: 1VA. Keep the lead length short to preserve accuracy (up to 0.5% full scale deviation). • The maximum of the external CT ratio is 3250 (i.e. 3250:1 or, preferably, 16250:5).
Generator current I2	Generator I2	
Generator current I1	Generator I1	
Generator common	GND	Optionally connected to CT -. For a 2-CT setup, see further.
Analog inputs		0...500Ω.
Common		Connect it to battery -.
Input 3	Available input	
Input 2	Available input	
Input 1	Available input	
Shield	GND	Ground plane.

⁽¹⁾ Not available according to controller type.

LOWER BLOCKS

⚠ WARNING
RISK OF EQUIPMENT DAMAGE
<ul style="list-style-type: none"> Connect battery negative to the module terminal 8...35VDC- with 2.5mm² (AWG13) cable.
Failure to follow this instruction can damage the controller.

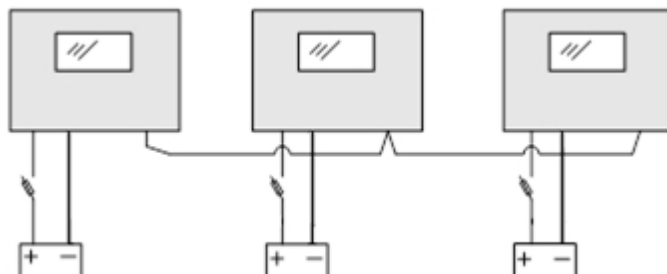

Block and mark	Description	Notes
7...38V_{DC}		
-	Power supply -	2.5mm ² (AWG13).
+	Power supply +	7...38VDC, consumed current: 130mA at 24V (standby and operation).
Shield	GND	Connect to the ground.
Digital outputs		
1	Available outputs	Free digital output (max: 1.8A). Protected against short circuits. A reactive load is supported. Not isolated from power supply.
2		
3		
4		
5		
6		
Digital inputs		
1	Available inputs	Free digital input with 10k pull-up. Accepts NO or NC contact to 0V. Not isolated from power supply.
2		
3		
4		
5		
6		
7		
8		
9		
CAN2: J1939-Extensions		Isolated CAN bus J1939/CANopen. Twisted pair.
	CAN L	Blue wire.
	CAN H	White wire.

TECHNICAL DOCUMENTATION

Block and mark	Description	Notes
	Resistor -	Strap to CAN H when inner resistor must be inserted (bus ends).
Shield	0V	Connect the cable shield herein.
Speed ⁽¹⁾		Compatible with all analog speed controllers. Isolated from power supply.
Out	Speed output +	Analog output ±10V to speed controller.
common	Speed output -	Twisted pair; length. < 5m (16ft) if unshielded, < 50m max if shielded.
AVR ⁽¹⁾		Compatible with most voltage regulators. Isolated from power supply.
Out	AVR output +	Analog output ±10V to voltage regulator.
Common	AVR output -	Twisted pair; length. < 5m (16ft) if unshielded, < 50m max if shielded.
CAN1 : CRE-Link® ⁽¹⁾		Isolated CAN© bus, use twisted pair.
	CAN L	White wire with blue strip (when using a CRE TECHNOLOGY cable).
	CAN H	Blue wire with white strip (when using a CRE TECHNOLOGY cable).
	Resistor -	Strap to CAN H when inner resistor must be inserted (bus ends).
Shield	0V	Connect the cable shield herein.
Pickup ⁽¹⁾		100Hz..10kHz. Voltage limits between + /-2...40VAC. Speed measurement for speed regulation, crank management and over-speed.
	Pickup +	Better option than alternator voltage.
	Pickup -	An over-speed shutdown device independent of the module is required. The alarm can be generated by ECU or by the module.

⁽¹⁾ Not available according to controller type.

WARNING

RISK OF EQUIPMENT DAMAGE

Switch off the unit before plugging or unplugging the CAN bus connector or disconnecting wires.

Failure to follow this instruction can damage the CAN transmitter/receiver.

Note: On loss of power supply, the unit survives for 70ms at 24V, and 20ms at 12V.

CONNECTION DIAGRAMS

These diagrams show that the PT (Potential Transformers) can be connected in various ways.

- Star (wye) on Generator side (1 insulated high-voltage terminal per PT); the ratio is for example:

$$\frac{U_{nom}/\sqrt{3}}{100}$$

- See on Bus side (2 insulated high-voltage terminals per PT); the ratio is for example:

$$\frac{U_{nom}}{100}$$

OTHER SYSTEMS OF VOLTAGE

For **bi-phase 180°** application, connect voltages and currents to L1-L3 terminals (and N). The same logic applies for I1-I3 (and common).

If **mono-phase** is selected, connect voltages and currents to the terminals L1-N. The same logic applies for I1

and common.

POWERING THE MODULE WITH A 12VDC BATTERY

A voltage drop from 12V to 6V can occur when the power consumption of the starter is too high and the battery undersized. This drop can reset the Module each time it gets powered. To counter this problem, a capacitor and a diode need to be wired as indicated in the schematic below:

The diode needs to be able to handle high currents (ex: Littelfuse DST2045AX). The value of the capacitor has to be around 24000 μ F (ex : KEMET capacitors).

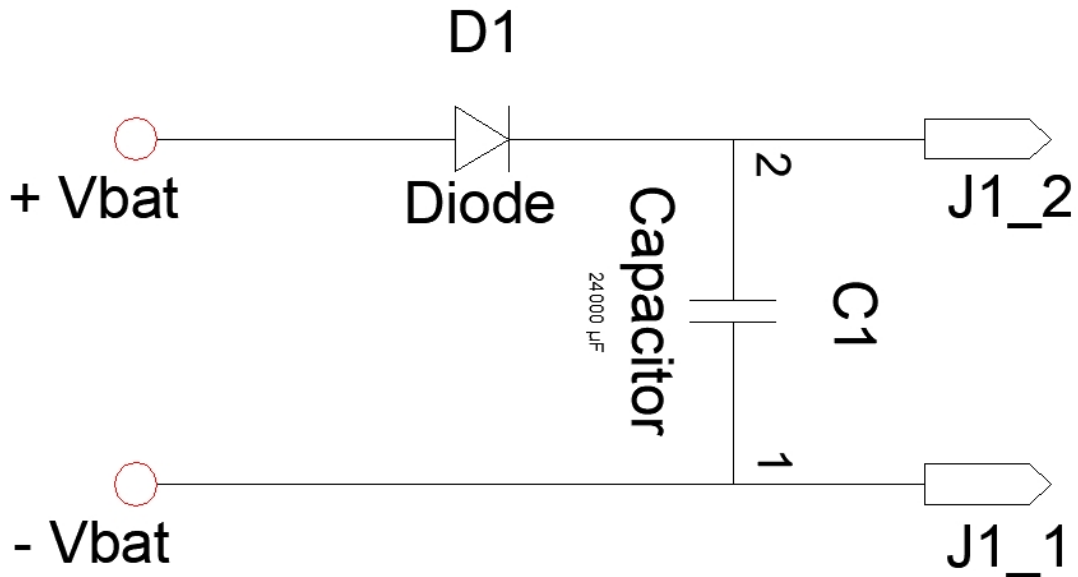

D+ WIRING

The D+ line of the alternator needs to be wired as shown below to ensure the magnetization of the field coil:

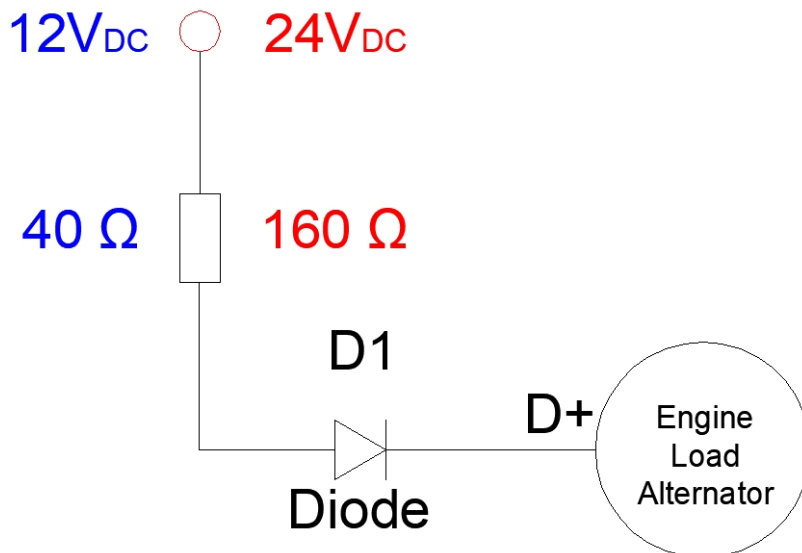

DIGITAL INPUTS

Several parameters can be configured from the *i4Gen Suite Software*:

- **Label**
- **Validity**
- **Direction**
- **T ON**
- **T OFF**
- **Function**

LABEL

This is the name you give to the input. The name will be shown in the digital inputs, information, alarm, and fault screens if programmed accordingly.

VALIDITY

Validity indicates when the digital input is taken into account. It can take four values:

Value	Validity	Description
0	Never	Never active: must be selected if you do not use the input.
1	Always	Always active: input is monitored as long as the module is powered.
2	Post-start	Input is monitored by the end of the "Safety on delay" [2004]. ⁽¹⁾
3	Stabilized	Input is monitored when the Generator is ready for use.

⁽¹⁾ Configure the protection inhibition time in *i4Gen Suite Software/Configuration/Time-outs and Delays*.

DIRECTION

For each input, two options are available:

Value	Label	Function
0	Normally open	To be used for standard cases unless the input is used as protection
1	Normally closed	Must be selected if the input is normally connected to 0V (open when active)

DELAYS

For each input, two delays can be defined in 100ms steps between 0 and 6553s:

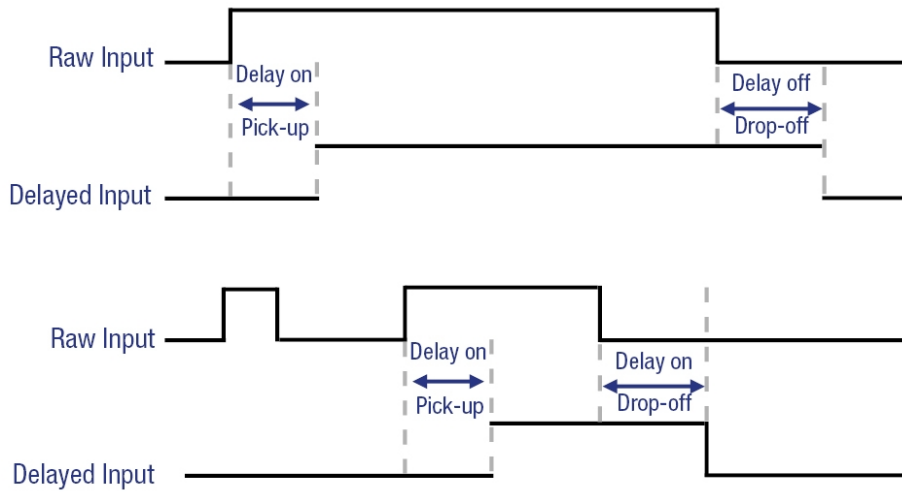

FUNCTIONS

Each input can be configured. To access all functions, use ***i4Gen Suite Software***.
Function list is available in [Software variables](#).

DIGITAL OUTPUTS

Several parameters can be configured from the *i4Gen Suite Software*:

- **Direction**
- **Function**
- **Pulse length: 0 means no pulse**

DIRECTION

Each output can be:

- **NE**: normally energized; the output is de-energized when its function is activated.
- **ND**: normally de-energized; the output is energized when its function is activated.

PULSE LENGTH

Each digital output can be configured to act as a pulse. The pulses lengths are defined with the parameters [2761] to [2766].

Set to 0 in order to have a continuous output (no pulse).

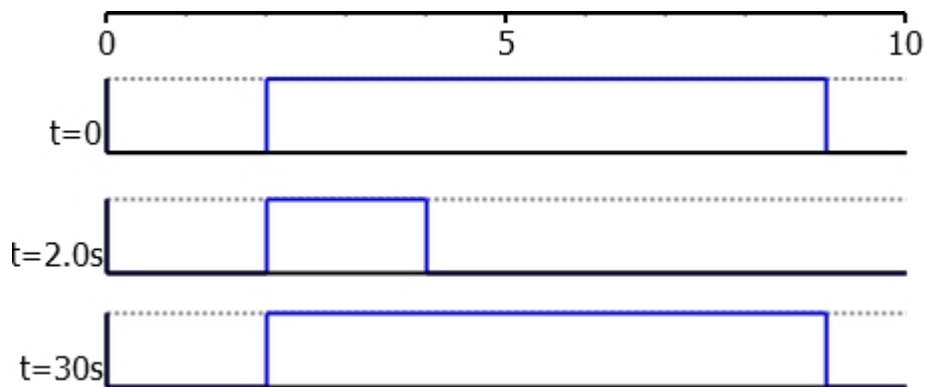

FUNCTIONS

Each output can be configured. To access all functions, use *i4Gen Suite Software*. Function list is available in [Software variables](#).

ANALOG INPUTS

In addition to the speed and electrical currents and voltages, three analog inputs are available. They measure a resistance 0...500 . However, they can serve as digital inputs or 20 mA transducer input.

INPUT

Each input is tagged with a name and preset to a function. It features several attributes preset in ***i4Gen Suite Software/Configuration/Inputs/Analog inputs***.

- **Function**
- **Unit:** No unit, V, KV, mA, A, KA, Hz, KW, KWh, KVAR, KVARh, rpm, %, Bar, mbar, KPa, psi, °, °C, °F, L, Gal, s, h, days, Hz/s, m3/h, L/h, Gal/h.
- **Calibration:** Measure value according to resistor value in .

CALIBRATION

Calibration is used to estimate a reading from a resistance value by interpolation between 2 wrapping resistance values. Negative values are supported for readings.

Enter a table in ***i4Gen Suite Software / Configuration / Inputs / Analog inputs***.

Enter the limits of reading according to the sensor calibration.

Calculate and enter the intermediary readings to get a linear distribution.

PROTECTIONS

Several parameters can be configured from the ***i4Gen Suite Software/Configuration/Protections/Engine/battery protections/Analog inputs protection***:

- Level (LV): limit value in units; it can be a low or high threshold.
- Delay (TM): time after which the protection is triggered.
- Validation (CT): protection type to which the signal contributes (8 potential values).
- Direction (SS): threshold polarity (0 = low, 1 = high).

Note: Do not confuse Validation with Validity (engine state that validates a digital input).

SUMMARY

The attributes are shown in ***i4Gen Suite Software***:

	Protections				
	Threshold	Timer	Control	Direction	Function
AI 1 level 1	2600	2601	2602	2606	2607
AI 1 level 2	2603	2604	2605		
AI 2 level 1	2608	2609	2610	2614	2615
AI 2 level 2	2611	2612	2613		
AI 3 level 1	2616	2617	2618	2622	2623
AI 3 level 2	2619	2620	2621		

USE OF AN ANALOG INPUT AS A DIGITAL INPUT

To mimic a digital input, connect the input to Power– through a switch, and select the function to implement in the list ***i4Gen Suite Software/Configuration/Inputs/Analog inputs/Function***.

Then set the delay, validity and polarity.

USE OF AN ANALOG INPUT AS A TRANSCEIVER INPUT

To act as a 0...20mA input or 4...20mA, connect the input with a 39 Ω resistor between the analog input and the analog common, and select the function 20mA in the list **i4Gen Suite Software / Configuration/Inputs / Analog inputs / Function**.

The calibration of the 20mA transducer can then be performed as on a resistive analog input depending on the characteristics of the sensor.

HOW TO CONNECT ANALOG OR DIGITAL SENSORS

You can use 1 or 2-wire analog sensors, or 1-wire or 2-wire logical sensors.

CRE RECOMMANDATION: In each case you must always connect the "common" J6 to the "- Power Supply" J1 and also connect it to the engine block in the case of 1-wire sensor.

You must use the following wiring (Incorrect wiring of the analog inputs can cause damage to the module, or cause a wrong measurement):

A-1 : Analog Sensor 2 Wires

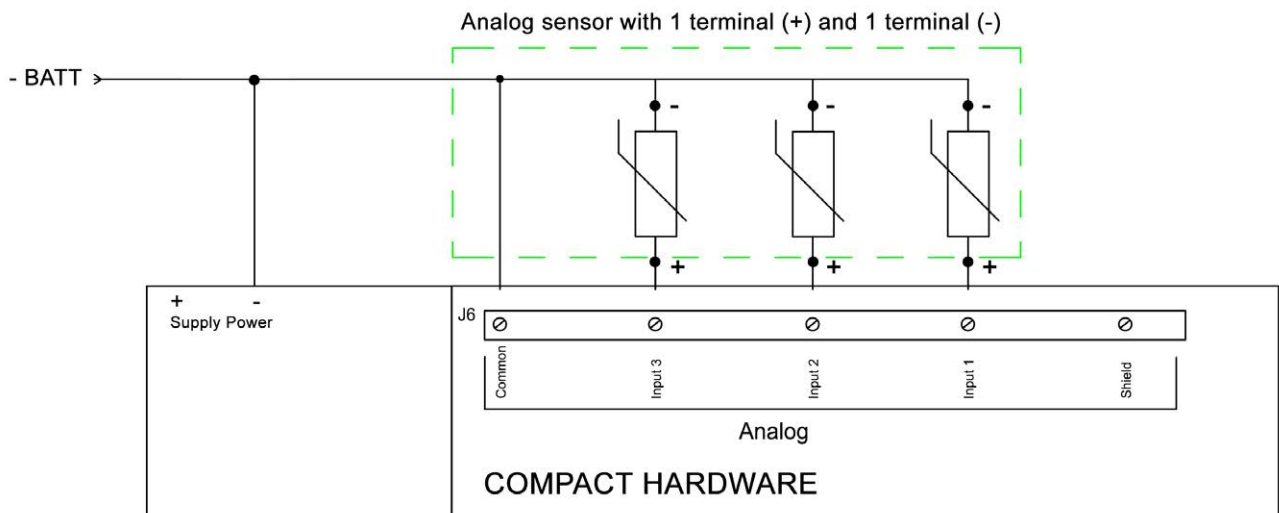

A-2 : Analog Sensor 1 Wire

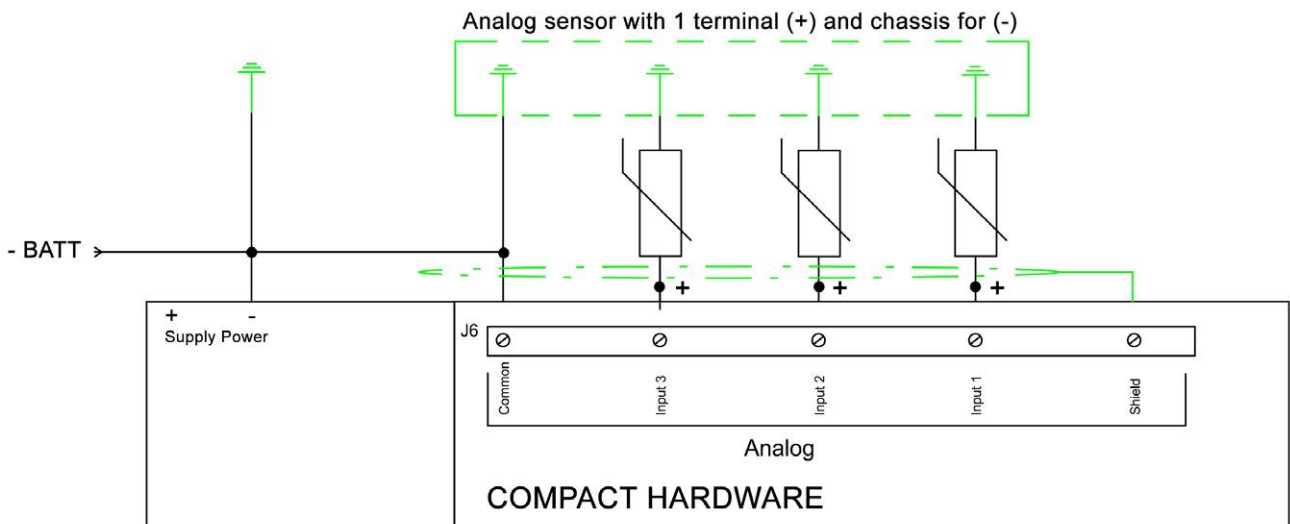

B-1 : Digital Sensor 2 Wires

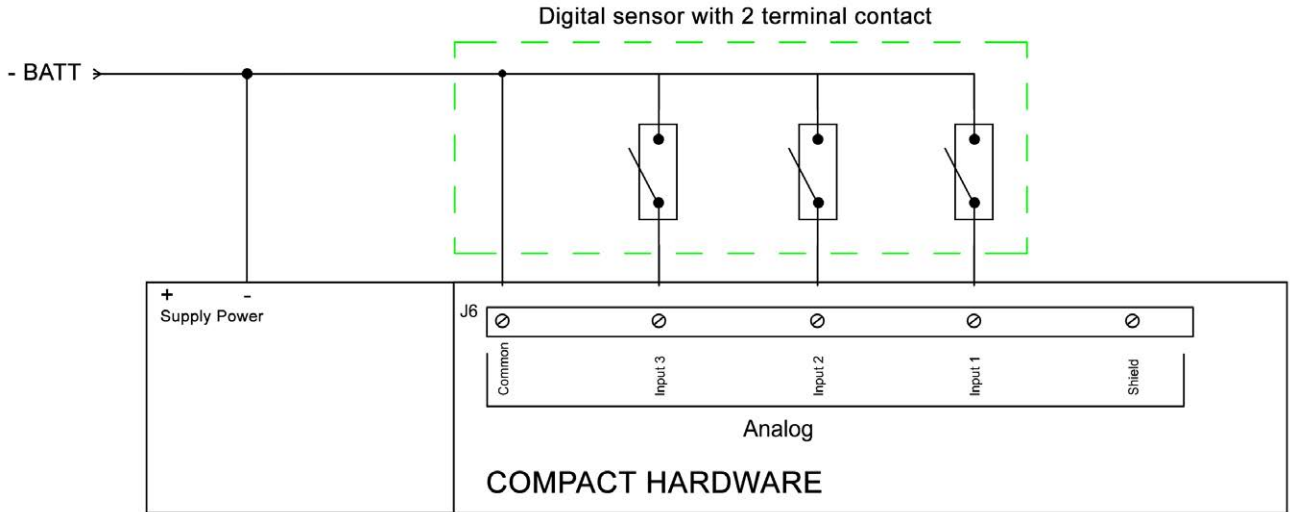

B-2 : Digital Sensor 1 Wire

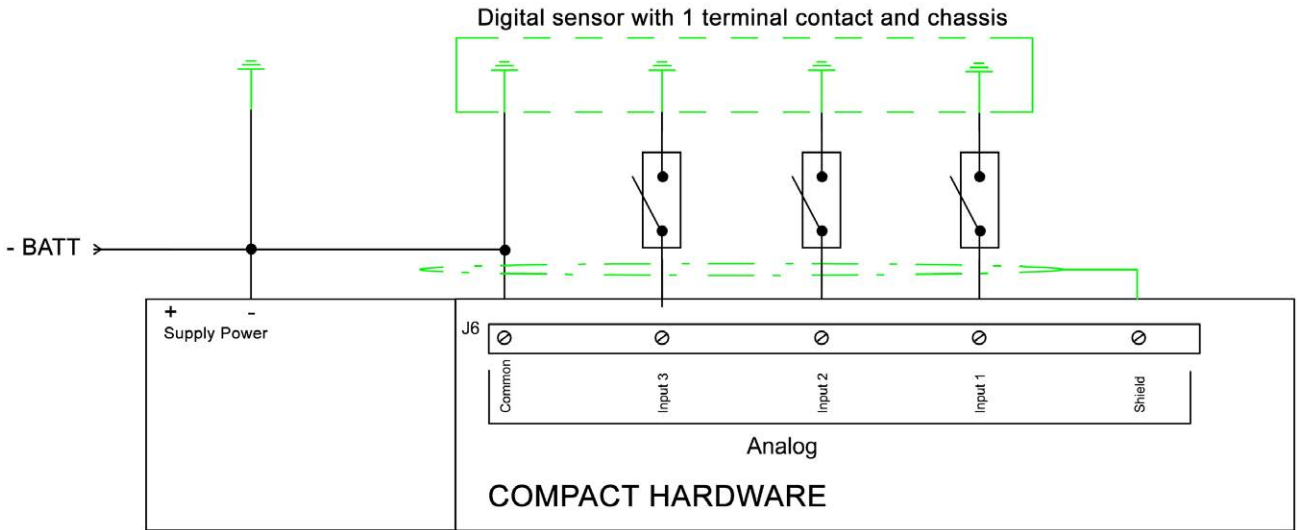

⚠ WARNING

The warranty will be void if the manufacturer's instructions are not respected.

HYSTERESIS DI

Hysteresis DI can only be set using *i4Gen Suite Software*.

For one given Hysteresis DI, it needs three different inputs/output to work:

- Two digital inputs are mandatory: one for the low threshold signal and one for the high threshold signal
- One digital output for the hysteresis to activate

First, open the **Controller configuration/Inputs menu** and select **Hysteresis DI**. Each hysteresis have the following parameters:

- **Hysteresis X enable for DI**
- **Timer**
- **Direction**

HYSTERESIS X ENABLE FOR DI

Enable/disable the hysteresis number X.

TIMER

The delay to wait once the condition is met (reaching low/high threshold for X amount of time) to set the digital output.

DIRECTION

For each hysteresis, two options are available:

Value	Label	Function
0	Set on low threshold, reset on high	The associated digital output will be set when the low threshold digital input activates and it will reset once the high threshold digital input activates. Please not that once the digital output is set, the low threshold digital input state will not matter. The digital output state can only change when the high threshold digital input activates.
1	Set on high threshold, reset on low	The associated digital output will be set when the high threshold digital input activates and it will reset once the low threshold digital input activates. Please not that once the digital output is set, the high threshold digital input state will not matter. The digital output state can only change when the low threshold digital input activates.

SETTING INPUTS FOR YOUR HYSTERESIS

To set a digital input, please refer to [Digital Inputs](#). The functions to use can be found under the **Hysteresis section** in the search engine.

SETTING AN OUTPUT FOR YOUR HYSTERESIS

To set a digital output, please refer to [Digital Outputs](#). The functions to use can be found under the **Hysteresis section** in the search engine.

HYSTERESIS AI

Hysteresis AI can only be set using *i4Gen Suite Software*.

For one given Hysteresis AI, it needs two different input/output to work:

- One analog input for the measure
- One digital output for the hysteresis to activate

First, open the **Controller configuration/Inputs menu** and select **Hysteresis AI**. Each hysteresis have the following parameters:

- **Activate Hysteresis on Analog Input X**
- **Low level threshold**
- **Timer on low threshold**
- **High level threshold**
- **Timer on high threshold**
- **Hysteresis Direction on Analog Input X**

ACTIVATE HYSTERESIS ON ANALOG INPUT X

Enable/disable the hysteresis on analog input number X.

LOW LEVEL THRESHOLD

The low level threshold will be activated on reaching this value and below.

TIMER ON LOW THRESHOLD

The delay to wait once the analog input value reaches the low level threshold before activating it.

HIGH LEVEL THRESHOLD

The high level threshold will be activated on reaching this value and above.

TIMER ON HIGH THRESHOLD

The delay to wait once the analog input value reaches the high level threshold before activating it.

HYSTERESIS DIRECTION ON ANALOG INPUT X

For each hysteresis, two options are available:

Value	Label	Function
0	Set on low threshold, reset on high	The associated digital output will be set when the low threshold value is reached and it will reset on reaching the high threshold value. Please not that once the digital output is set, the low threshold value will not matter. The digital output state can only change on reaching the high threshold value.
1	Set on high threshold, reset on low	The associated digital output will be set when the high threshold value is reached and it will reset on reaching the low threshold value. Please not that once the digital output is set, the high threshold value will not matter. The digital output state can only change on reaching the low threshold value.

SETTING AN OUTPUT FOR YOUR HYSTERESIS

To set a digital output, please refer to [Digital Outputs](#). The functions to use can be found under the **Hysteresis section** in the search engine.

SETTINGS

SPEED/VOLTAGE CONTROL

INTRODUCTION

The module allows speed or voltage control with the following possibilities:

- Correction with two analog signals (speed and voltage) +/- 10VDC with amplitude and adjustable offset.
- Correction with pulses output (+speed/-speed and +V/-V).
- Correction with J1939 frames only for speed.











[4405] is the speed/KW correction applied to speed governor (value given in percent).

[4411] is the voltage/KVAR correction applied to voltage regulator (value given in percent).

Follow carefully the configuration procedures (amplitude and offset adjustment) in this chapter in order to obtain efficient synchronization, load sharing and droop mode.

ANALOG OUTPUT FOR SPEED CONTROLLER







The speed output sends the required frequency set-point to the speed controller during synchronization and KW control (load sharing, ramp up/down). The voltage output -10V...10VDC must be adjusted in amplitude and offset to allow the module to vary the speed regulator set-point in a proper range; in order to control the speed in a band of +/- 2.5Hz around the nominal frequency.

1. Start the Generator in **MAN** mode by pressing  and then .
2. Adjust the speed value on the speed governor to get the nominal frequency 50Hz (or 60Hz).
3. Connect the speed output and speed common terminal. Adjust the offset parameter to obtain a frequency of 50Hz (or 60Hz).
4. Increase manually the engine speed at its maximum (100%) by pressing  + , then adjust the amplitude to obtain a frequency of 52.5Hz (or 62.5Hz).
5. Return to a 0% speed correction by pressing  + , then adjust the offset again if necessary to obtain a 50Hz (or 60Hz) frequency.
6. Change the speed correction to minimum (-100%) by pressing  +  and check that the frequency is 47.5Hz (or 57.5Hz).
7. Return to 0% speed correction by pressing  + .
8. Press  to stop the Generator.

The application note **COMPACT PLATFORM_SPEED GOVERNOR WIRING ADJUSTMENTS_EN** gives the parameters to be set for several speed governor models. To use the module with other models, adjust the amplitude and offset according to explications above.

ANALOG OUTPUT FOR VOLTAGE REGULATOR

The voltage output sends the required voltage set-point to the voltage regulator during voltage synchronization and reactive load sharing. The voltage range -10V...10V must be adjusted in amplitude and offset to allow the module to vary the voltage regulator set-point in a correct range; in order to control the voltage in a band of +/- 30V around the nominal phase-phase voltage:

1. Start the Generator in **MAN** mode by pressing the  then  buttons.
2. Adjust the voltage value on the voltage regulator to get a nominal phase-phase voltage of 400V (or 480V).
3. On the module, connect the AVR output and AVR common terminal. Adjust the offset to obtain a voltage of 400V.
4. Increase manually the Generator voltage at its maximum (+100%) by pressing  +  then adjust the amplitude to obtain a voltage of 430V (or 510V).
5. Return to a 0% voltage correction, then adjust the offset again if necessary to obtain a voltage of 400V.
6. Change the voltage correction to minimum (-100%) by pressing  +  to check that the voltage is 370V (or 450V).
7. Return to 0% voltage correction.
8. Press  to stop the Generator.

The application note **COMPACT PLATFORM_AVR-DVR WIRING ADJUSTMENTS_EN** gives the parameters to be set for several AVR models. To use the module with other models, adjust the amplitude and offset according to explications above.

SPEED/VOLTAGE CONTROLLED BY CONTACTS/PULSES

When digital outputs are connected to the speed governor and/or AVR, the module changes the state of these outputs according to the result of the current PID:

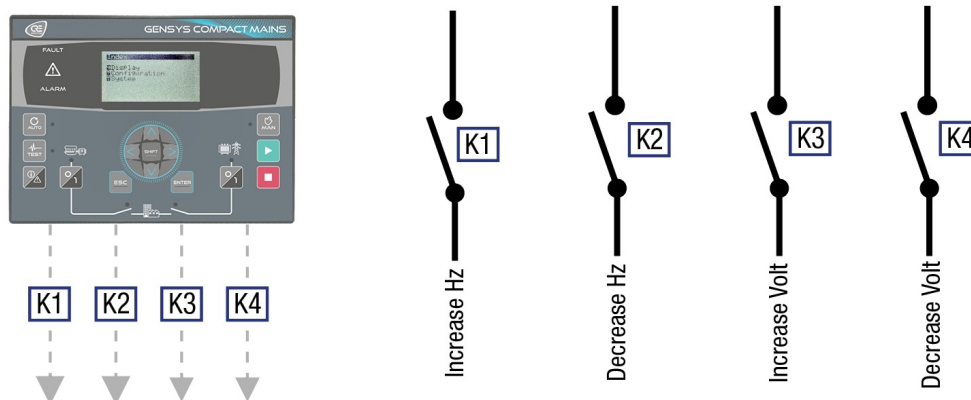

A digital potentiometer converting pulses into analog values can be used. A digital potentiometer has its own parameters: ΔU_0 (fsd) and timer.

In **i4Gen Suite Software/Configuration/Outputs/Digital outputs/relays**, set the respective functions (increase/decrease speed by pulse and increase/decrease voltage by pulse) to the desired +Speed/-Speed and +V/-V outputs.

A pulse is generated when the absolute value of the correction applied exceeds the dead band. The larger the correction signal ([4405] for speed and [4411] for voltage), the longer the pulses are and the shorter the time between each pulse is. The **Pulse divider** parameter is used to reduce or increase the pulse length for the same correction value.

1. Adjust the speed/voltage regulator to its nominal value (unless the controller module connection is direct).
2. If the Generator makes too much or too little correction during an active phase (synchronization, load sharing...), the **Pulse divider** is not adapted:
 - Decrease [3652]/[3653] to reduce the action on the regulator.
 - Increase [3652]/[3653] to increase the action on the regulator.
3. If the Generator oscillates around the set-point or fails to reach the set-point, the dead band is not adapted:
 - Decrease the dead band [3650]/[3651] to improve accuracy around set-point.
 - Increase the dead band [3650]/[3651] if the Generator oscillates in frequency or power.
4. If a digital potentiometer is connected between the module and the regulator, set U (fsd) and the delay time; if the compensation is not as expected, check the following points:
 - Is the potentiometer active when the module sends a signal ?
 - Is the range managed by the potentiometer sufficient ?

Note: If each pulse causes overcompensation, the potentiometer engine may have continued to run even in the absence of a pulse. A shunt resistor on the potentiometer input can correct this problem by forcing a low level on the input in the absence of pulse.

SYNCHRONIZATION

FUNCTIONING

The module starts an automatic synchronization when a remote start [4579] is activated. The nominal voltage and frequency must be between the under frequency/voltage protection ([2403] and [2409]) and the over frequency/voltage protection ([2400] and [2403]) in order for the synchronization to work. These parameters can be set in **Configuration/Protections/General protections/Over/under frequency** and **Configuration/Protections/General protections/Over/under voltage**.

It manages a correction on frequency and voltage to go and stay on the acceptance windows (can be handled in **Synchronization**).

In case of synchronization fails, the action can be set with the variable [2804] in **Configuration/Synchronization**.

CONDITION

Voltage acceptance [2800].

Frequency acceptance [2801].

Phase angle acceptance [2802].

C2S dwell time (Synchronization dwell time before authorizing to close the breaker) [2809].

VISUALIZING

Label	Description	Variables
Phase sequence match	Phase sequence match allowing to close the circuit breaker.	[306]
Voltage match	Voltage match allowing to close the circuit breaker.	[307]
Frequency match	Frequency match allowing to close the circuit breaker.	[308]
Phase match	Phase match allowing to close the circuit breaker.	[309]
Authorization to close breaker	Authorization to close the circuit breaker.	[310]

CHRONOGRAM

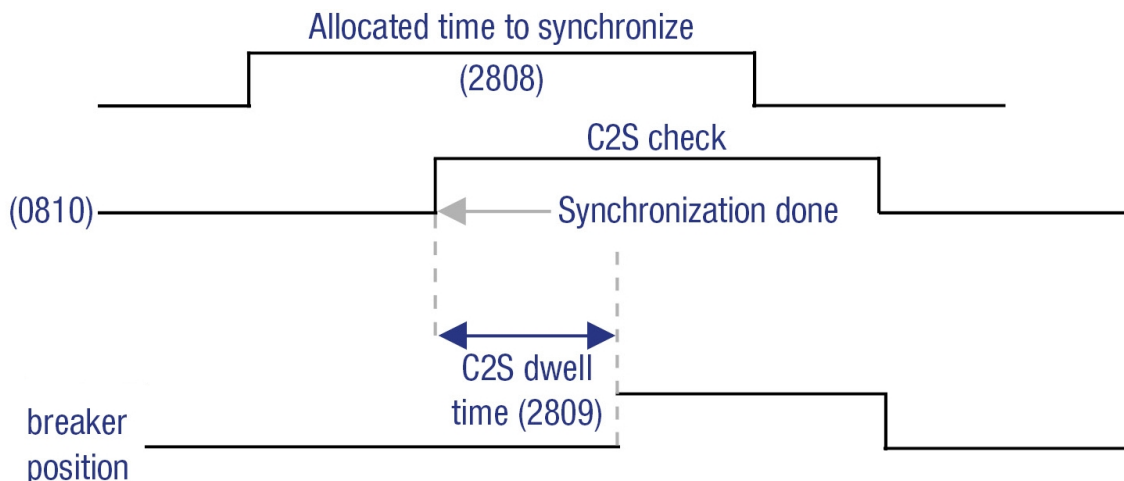

ADJUSTMENTS

Prerequisite: The speed and voltage outputs control must be set as described in [Speed/voltage control](#).
 The voltage and the frequency of the Bus must be in their nominal value.
 The PID parameters can be set using **Configuration/Control Loop**.

ADJUSTMENT PROCEDURE

DANGER	
	RISK OF ELECTRIC SHOCK, EXPLOSION OR ARCING
	<ul style="list-style-type: none"> ▪ The module may only be installed and maintained by qualified electricians. ▪ Use personal protective equipment (PPE) ▪ Follow good safety practices for electrical work. ▪ Turn off the power before installing or replacing a fuse, and before installing the module. ▪ Use equipment adapted to check the absence of voltage. ▪ Do not use a resettable fuse.
	Failure to follow these recommendations may result in death or serious injury.

1. Disconnect the circuit breaker control output on the module.
2. Make sure that there is some voltage on the Bus side. The Bus LED should be lit.
3. Check the **Display/Synchronization** page and activate a remote start [3751].
4. The Generator should synchronize within 5 seconds. If it is not the case, isolate the cause (voltage, frequency or phase). Depending on the source of the issue (voltage, frequency or phase) change the corresponding PID parameters available in **Configuration/Control loops**. [Control loop PID](#) chapter to see how to manage PID settings.

VERIFICATION

1. Disconnect the circuit breaker control output on the module.
2. Make sure that there is voltage on the Bus side. The Bus/Mains LED should be lit.
3. Activate a remote start [3751].
4. Press  to go to the Information page and check if the module is in synchronizing mode.
5. Go to **Display/Synchronization** and check the phase difference. When the phase difference is 0° follow the instructions bellow:
 - Check the rotating fields and the concordance of the phases upstream and downstream of the circuit breaker.
 - Check the wiring of the Generator and Bus voltage references.
 - Check the potential difference between Ph1 Gen and Ph1 Bus. The potential difference must be bellow 10% of the nominal voltage. Check the potential difference between Ph2 Gen and Ph2 Bus/Mains as well.
6. Deactivate the remote start [3751].
7. Reconnect the circuit Generator breaker control.
8. Activate a remote start [3751]. The Generator should synchronize and then close its Generator breaker.

CONTROL ON DEAD BUS MANAGEMENT

In case of an emergency start of the Power plant (no voltage on the common Bus-bar), the units communicate through **CRE-Link®** to elect a module which will close first its circuit breaker on the Bus-bar: it is the arbitration procedure, to avoid closing 2 circuit breakers at the same time, when the generators are not synchronized. With a failure of the **CRE-Link®** communication, the units switch on a safe mode to protect the circuit breaker closing procedure. Each closing commands will be delayed depending on the number of the unit.

Formula:

Generator #n will close its circuit breaker after $([2306]/10) + (7 * n)$ seconds.

[2306]: Delay to close breaker if there is a CAN bus fault. Default value: 15.0s.

PROTECTIONS

FUNCTIONING

The protections are triggered by an internal or external event (alarms, faults, logic inputs, CAN bus loss, etc.). Two actions can be associated to each event:

- An alarm; warning can be viewed on the LCD screen; a report can be retrieved.
- A fault; warning can be viewed on the LCD screen; a report can be retrieved.

Value	Type	Action	Description
0	–	Off (no action)	–
1	Fall-back	Generator electrical fault	The protection opens the Generator circuit breaker and tries to re-synchronize again after the timer [2806]. The number of resynch attempts is set by variable [2807], it means that if the fault that has tripped the Generator circuit breaker is happening again after each attempt, the Generator will be stopped. The number of attempts is reset with the reset function.
3	Alarm	Alarm	Notice as alarm on front panel, displayed information only, no action.

These actions have to be configured with *i4Gen Suite Software*. List of potential alarms/faults can be downloaded via *i4Gen Suite Software/System/PC transmit/receive: List of actions on alarms-faults*.

A digital output can be configured to indicate that the protection is active.

All the protections available for the product are explained in the protection chapter [Software variables](#). Specific protections are explained below.

COMMUNICATION

Alarm/Fault	Description	Setting
CANopen	Communication error on CANopen.	[3058]

For **CRE-Link®** errors, check [CRE-Link®](#).

AUDIBLE OR VISUAL WARNING DEVICE

To trigger an external alarm when a protection trips, connect the alarm to a logic output configured as a "Horn". The signal duration is configurable by [2478] (0 means that the alarm will be activated until manual shutdown); alternatively, an input can be configured as "Horn Off" to manually stop the horn:

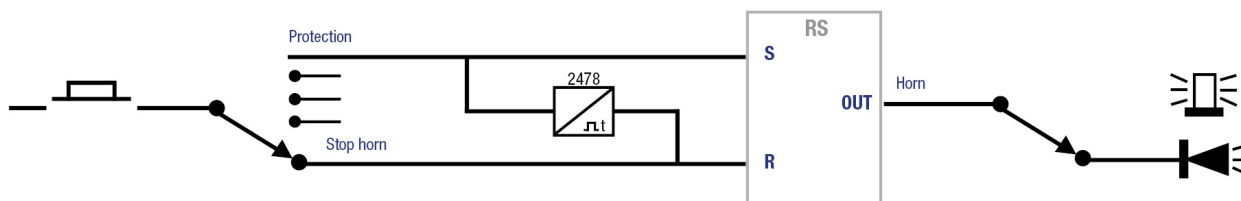

ALARM/FAULT RESET

To perform an alarm/fault reset:

- Locally:  + 
- Remote: use the "**Reset faults**" input function.

CONTROL LOOP PID

EMPIRICAL PID GAIN TUNING

1. Set all the gains to 0 (except G gain).
2. Increase the P gain until you have a stable oscillation.
3. Increase the D gain until the oscillation is canceled.
4. Repeat steps 2 and 3 until the D gain can't cancel the oscillation caused by the P gain.
5. Go back to the previous values of the P and D gains where the D gain cancels the oscillation caused by the P gain.
6. Increase the I gain in order to correct the error between the actual value and the set-point. Warning: A too high I gain might cause oscillations to the system. The I gain must correct the static error rapidly without oscillations (or small oscillations in order to gain some response time).

ADVANCED FUNCTIONS

For more information about Easy Flex, Alternative selection and Scheduler functions, see the technical documentation of i4Gen Suite software.

MODBUS TCP MAPPING

CONFIGURABLE BLOCK

To create your own blocks, use the variables [10000]...[10299] in ***i4Gen Suite Software/Configuration/Modbus redirection***.

There are two ways to configure these blocks:

1. Configuration in ***i4Gen Suite Software/Configuration/Modbus redirection***: enter the codes of the variables to read; the readings on the registers [10000]...[10299] will be the pointed values.
2. Configuration by an external device; this device must request the following:
 - Write 1 to [3016] to enter into the configuration mode.
 - Write the codes to the desired registers ([10000]...[10299]).
 - Write 0 to [3016] to enter into the read mode.

Then to read your own block, you just need to read by Modbus TCP the register [10000]...[10299].

Example:

If the configuration is as follows [10000] = 14; [10001]=15; [10002]=16, the reading by Modbus TCP of the 3 registers will give to you the hours/minutes/seconds of the module.

LOGGER

The **Logger** tool is used to track value or status changes up to 10 variables at the user's choice. Power status variable is always recorded as long as the logger is not set to Off. This function is available in ***i4Gen Suite Software/Configuration/Logger***.

Additional Functions

For each variable you can set a log period down to tenth of a second (example: 0.1s).

To use this function, select **Interval** in **Log on** box.

The **Erase logger** button will delete all recorded variables from the module.

A lot of variables can be recorded, (see [Software variable](#) appendix to select the needed variable).

COMMUNICATIONS

NETWORK

SETTING UP YOUR PC CONNECTION

Materials required:

- A CAT 5 cross Ethernet cable (marked CROSSOVER CABLE along its sheath) for direct connection to the module from your computer.
- The CAT 5 straight Ethernet cable (marked PATCH CABLE or STRAIGHT-THROUGH CABLE along its sheath) can only be used with an Ethernet switch.

CONFIGURING THE COMPUTER IP ADDRESS

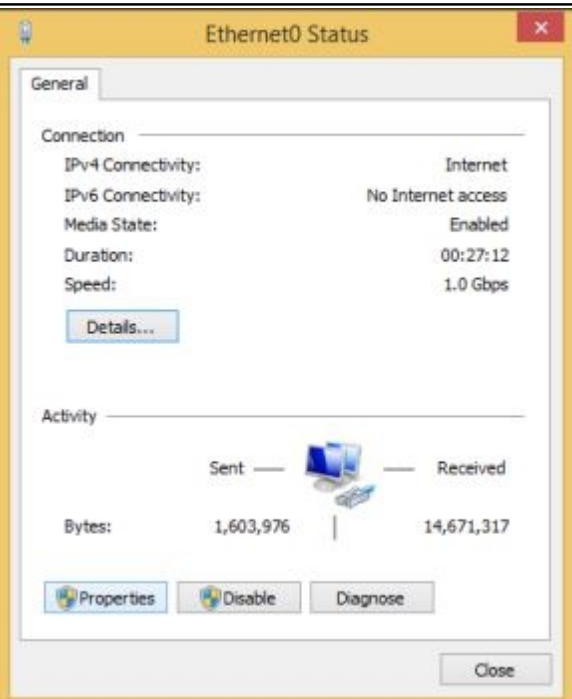
<p>Connect the module with a 100 Ethernet cord</p>	<p>Direct connection to PC: use a crossover cord. Connection through a switch: you can use either a direct or a crossover cable such as 3-m long A53W1, as long as your switch uses auto MDI/MDIX technology.</p>
<p>Power up the module using a stabilized power supply.</p>	
<p>Open Windows control panel</p>	
<p>Open Network and Sharing Center / Change adapter settings / (Connection to) LAN / Properties (Windows 7 & 8 & 10).</p>	

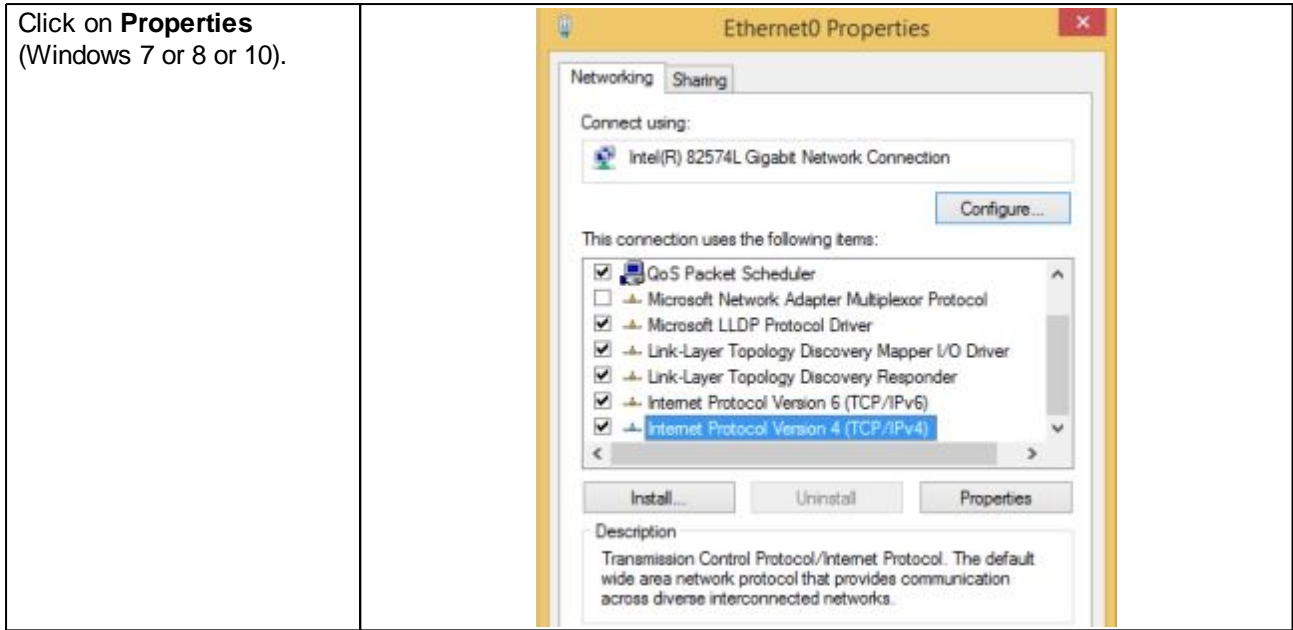

CHANGE THE IP ADDRESS OF THE MODULE

Using **i4Gen Suite Software** (or LCD display), in the **System/Network Configuration** menu. The module supports DHCP: in this case, the module must be connected to a network equipped with a DHCP server.

On power-up, the module obtains an IP address from the DHCP Server.

If the DHCP protocol fails, the fixed IP address of the module is used (Factory setting: 192.168.11.1).

On core module, you can reset the IP address (192.168.11.1) by holding the button on the rear face when the module is powered.

Note: Contact your network administrator to configure your router and/or the units according to your needs.

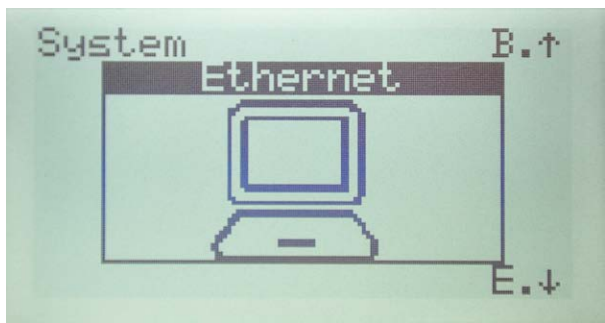

HOSTNAME

It is possible to assign a device name to the module in relation to its IP address; You can then use this device name in **i4Gen Suite Software** to connect to the module. The device name can be change in **i4Gen Suite Software/System/Network Configuration** menu. Maximum length: 16 characters. In Windows, the last character defines the type of service (0 is the usual value). Allowed characters: reduced ANSI set; "-" and "." are allowed except as first and last characters.

MODBUS TCP/IP

ABILITIES

The complete list of variables is described in [Software variables](#).

Through Ethernet communication where the module acts as a Modbus slave, you can:

- Upload many readings and module internal variables.
- Download values for many module internal variables.

Type	Range	Fault access right
Readings (measurements, states,...).	[0000] ... [1999]	Read only.
Parameters.	[2000] ... [3999]	Read/Write.
Modes, statuses, settings,...	[4000] ... [9999]	Read.
Readings associated with digital inputs.	[4500] ... [4649]	Write (subject to activation).

SUPPORTED FUNCTIONS

In addition, the following functions are supported:

- Reading bit-fields, listed in a dedicated tab of the file and organized in 16-bit words. These variables are listed in [Software variables](#).
- Reading contiguous configurable data block.

Those functions allow a significant performance gain and help reducing the load on an Ethernet network.

CONFIGURATION

To communicate through Modbus TCP, define the following settings:

- Module IP address set in **System/Ethernet**.
- Modbus TCP port [3014], generally 502, set in **System/Ethernet**.
- Modbus TCP rights: see further.

The module handles up to 4 simultaneous connections. This can be used for multiple HMIs for example. For more details on the Ethernet configuration, see [Network](#).

FUNCTIONS

The module supports the following Modbus functions:

Functions	Description
01, 02	Read logical data (Coil status, discrete input status).
03, 04	Read holding/input registers (16 bit).
05	Write logical value (single coil).
06	Write single register (16-bit variable).
15 (0x0F)	Write multiple logical values (multiple coils).
16 (0x10)	Write multiple registers.

All module variables are 16-bit registers. Yet it might be useful to consider them as logical values (if they are only set to 0 or 1) to simplify Modbus TCP communication with some external PLC. If function 01 or 02 is used to read an internal register that is different from 0, then returned value will be 1.

The module registers start from address 0. Depending on your Modbus TCP client equipment-software, you may need to use an offset of 1 when reading/writing registers as addresses may start from address 1. In this case, request address/register number 1 to access variable 0000 inside the module.

The 32-bit variables can only be written using 0x10 function.

If a digital input modifies a piece of data also to be written by Modbus, the latest request takes over the other.

Data [10000]...[10299] can be read by block (see further).

ACCESS RIGHTS

The access rights depend on the parameter type and on Modbus access permissions. To manage access rights, set to 1 the corresponding bits in the word [3015]:

Description	Bit #	Default value
Writing to date/ time	0	0
Writing to Engine counters	1	0
Not used	2	0
Writing to digital input function register	3	1
Not used	4	0
Not used	5	0
Not used	6	0
Not used	7	0
Reading via Modbus TCP	8	1
Writing via Modbus TCP	9	1

Using *i4Gen Suite Software/System/Network configuration/Modbus TCP access rights*, you can tick checkboxes to set those:

Bit #	Label	Use
0	Writing to date/ time	Module time synchronization.
1	Writing to Engine counters	Manual counter adjustment (see following table).
3	Writing to digital input function register	Opens the possibility to activate a digital input function using Modbus TCP.
8	Reading using Modbus TCP	Opens the possibility to grant reading individual permissions.
9	Writing using Modbus TCP	Opens the possibility to grant writing individual permissions.

The counters, encoded on 32 bits, include:

Meters (MSB LSB)	Label
0080 0079	Generator KWh
0082 0081	Generator KVARh
0084 0083	Engine running hours

BITFIELDS

Bit-fields are meant for decreasing communication bus load. They pack up to 16 logic variables inside a single register. This way, a single Modbus TCP request can be used to read a chunk of information. Each variable contains the current value of 16 logic variables such as breaker positions, faults, alarms...

They are listed out in [Software variables](#).

The bit-fields [0956]...[0969] have latched values: a reset is required for them to return to 0.

*Note: Available data are related only to faults that occurred after the latest power up sequence. Events that occurred before the module has been power cycled are listed in the **FAULT** pages but not among the variables.*

MODBUS COMMUNICATION EXAMPLE

The table below shows a Modbus TCP client sending a reading request (function 04) of 6 registers starting from variable [0079].

Client request		Module server response	
Field	Value	Field	Value
Function code	04	Required function.	04
Starting Register (MSB)	00	Data bytes (=2*Nb of registers requested).	6
Starting Register (LSB)	79	Value of register 0079 (MSB).	D0
Count of registers (MSB)	00	Value of register 0079 (LSB).	D1
Count of registers (LSB)	06	Value of register 0080 (MSB).	D2
		Value of register 0080 (LSB).	D3
		Value of register 0081 (MSB).	D4
		Value of register 0081 (LSB).	D5

CRE-LINK®

PRESENTATION

This CAN bus is used as a communication means between units of a single Power plant, featuring:

- Active and reactive load sharing.
- Automatic load/unload.
- Static paralleling.
- Dead bus management.
- Segments and Power plant management.
- Other data exchange.

Standard CAN bus rules apply here. Refer to [CAN bus good practices](#) to connect units properly on CAN bus.

CAN BUS ALARMS/FAULTS

CAN communication between **CRE TECHNOLOGY** units is continuously checked by each unit on the CAN bus. The count of units connected to CAN bus must be the same as the count of units declared inside each unit. In case of a problem on the bus, alarms or faults can occur:

- Missing product: One or several **GENSYS COMPACT PRIME** are missing on the **CRE-Link®**.
- Missing master: One or several **MASTER COMPACT/BTB COMPACT/MASTER 1B COMPACT** are missing on **CRE-Link®**.
- Isolated product: The communication with the other products is lost. Check that the 120 termination resistors are used correctly (see [CAN bus good practices](#)). Check that CAN bus cable is properly connected.
- Unknown product: An incompatible product is connected on the CAN bus. The module will not start the Generator.
- Mismatch version: A module with an incompatible version is connected on the CAN bus. The module will share the load using droop.

Note: Problems can occur if two or more unit have the same Generator number.

For **Missing product**, **Missing master** and **Isolated product**, you can configure the behavior to be adopted in case of a CAN fault.

CANOPEN

CANopen extension modules can be used to increase the number of digital inputs and outputs of the module. Overall max. count of added inputs/outputs: 32 I and 32 O. They are read/written every 100ms.

CONFIGURATION

Setting	Label	Value	Description
[3151]	CANopen config	1 2 3 4	8 inputs + 8 outputs of coupler ID# 1 16 inputs + 16 outputs of coupler ID# 1 32 inputs + 32 outputs of coupler ID# 1 Custom configuration, defined by more settings.
[3153] [3154] [3155]	CANopen ID# 1 CANopen IN 1 CANopen OUT 1	0 ... 255 0 ... 32 0 ... 32	Identifier of the first coupler. Count of inputs on the first coupler. Count of outputs on the first coupler.
[3156] [3157] [3158]	CANopen ID# 2 CANopen IN 2 CANopen OUT 2	0 ... 255 0 ... 32 0 ... 32	Identifier of the second coupler. Count of inputs on second coupler. Count of outputs on the second coupler.
[3159] [3160] [3161]	CANopen ID# 3 CANopen IN 3 CANopen OUT 3	0 ... 255 0 ... 32 0 ... 32	Identifier of the third coupler. Count of inputs on the third coupler. Count of outputs on the third coupler.
[3162] [3163] [3164]	CANopen ID# 4 CANopen IN 4 CANopen OUT 4	0 ... 255 0 ... 32 0 ... 32	Identifier of the fourth coupler. Count of inputs on the fourth coupler. Count of outputs on the fourth coupler.

The assignment of I/Os is done in the order of couplers and the lower variable number is associated to the lower message number configured.

The CANopen inputs and outputs have the same attributes as regular inputs and outputs except the delay on drop-off of inputs:

Setting	Attribute
Digital inputs 1 ... 32	
[3200] ... [3231]	Function
[3232] ... [3263]	Delay on pick-up
[3264] ... [3295]	Validity
[3296] ... [3327]	Direction
Digital outputs 1 ... 32	
[3350] ... [3381]	Function
[3382] ... [3413]	Mode (direction): 0: Normally de-energized 1: Normally energized

On power-up, the configuration is automatically launched. The status [3150] turns to 1. The error time-out [3152] is 10.0s by default.

VARIABLE MAPPING AND INPUTS/OUTPUTS

CANopen inputs and outputs are accessed by their code:

- Inputs: [0800]...[0831]
- Outputs: [4751]...[4782]

SAE J1939

PRESENTATION

J1939 is a CAN protocol used by “electronic” motors, which include an ECU (or ECM, EMS). It allows you to read engine and alternator data (measurements, positions, binary values), and send commands (start, stop, speed control...).

The ECU can detect faults and send them to the module. Protections can be assigned to these faults (see further).

Bit rate: 250kbit/s.

To use J1939 communication:

1. Enter the **i4Gen Suite Software/Configuration/Engine/J1939** page
2. In the list, select the manufacturer [3100]
3. Select the ECU type [3101]
4. Assign the alarms/faults to a protection (see bellow)
5. Connect the engine ECU and the module J1939 port

The pair manufacturer-ECU determines the following settings:

- Module address on the CAN bus.
- ECU address on CAN bus.
- Speed control: through J1939 or by analog output/pulses.
- Start-stop control: through J1939 or by crank and fuel digital outputs.
- Speed, oil pressure, coolant temperature measured by J1939.

*Note: if needed, it is possible to measure speed, oil pressure and water temperature by analog input instead of J1939. To do so, use switch selection in **i4Gen Suite Software/Configuration/Engine/Control Settings**.*

MEASUREMENTS AND POSITIONS

The next table lists out the measuring points whose values are conveyed over **CRE-Link®** and taken into account by the module. The J1939 standard assigns each of them an SPN (Suspect Parameter Number), as it will be used to label the alarms.

Refer further to the three schematics and tables for description and location.

Legend:

P	Δp	T	L	FR	Q	Tq	V	W
Pressure	Diff. pressure	Temperature	Thre shol d	Flow (Flow-Rate)	Consumption	Torque	Voltage	Power

To be conveyed, they are grouped in frames; each frame is identified by a PGN (Parameter Group Number).

Note: For more information on the J1939 protocol and the exact definition of each SPN and PGN, refer to the norm.

FUEL CIRCUIT AND ECU

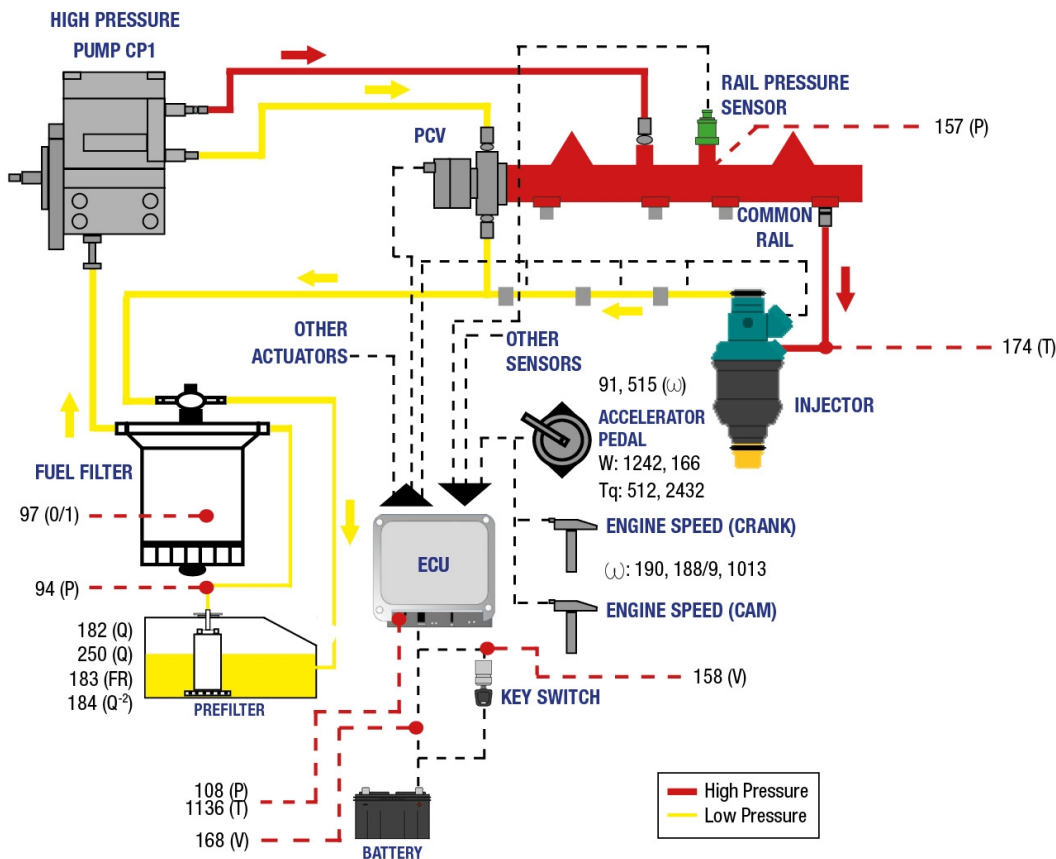

SPN	Description	PGN
91	Accelerator pedal position 1 (run in %).	F003
1242	Instantaneous estimated brake power.	FE92
512	Driver's demand engine - Percent torque related to maximum engine torque.	F004
515	Engine's desired operating speed. Indication of optimal speed for the current conditions. May include the torque generated to accommodate power demands and exclude dynamic commands from smoke/shift.	FED F
2432	Engine demand - percent torque.	F004
190	Engine speed.	F004
188	Engine idle speed.	FEE3
189	Engine rated speed (max. rotational velocity of engine crankshaft under full load conditions).	FEB E
166	Engine rated power (net brake power at rated speed).	FEB E
1013	Trip maximum engine speed since latest trip reset.	FEB7
171	Ambient air temperature.	FEF5
182	Engine trip fuel (fuel consumed during all or part of a run).	FEE9
250	Engine total fuel used.	FEE9
183	Engine fuel rate.	FEF2
184	Engine instantaneous fuel economy (covered distance/fuel consumption).	FEF2
94	Engine fuel delivery pressure (as delivered by supply pump to high pressure pump).	FEFF
97	Water in fuel indicator (binary signal).	FEFF
157	Engine injector metering rail 1 pressure.	FED B
174	Engine fuel temperature 1 (at injector inlet).	FEE E
168	Battery potential /Power input1.	FEF7
158	Key switch supply potential (alternative to 168).	FEF7
1136	ECU temperature.	FEA4

TECHNICAL DOCUMENTATION

108	Barometric pressure.	FEF5
1387	Pressure auxiliary sensor #1	FE8 C
1388	Pressure auxiliary sensor #2	FE8 C
247	Engine total hours of operation.	FEE5

AIR, EXHAUST AND ALTERNATOR

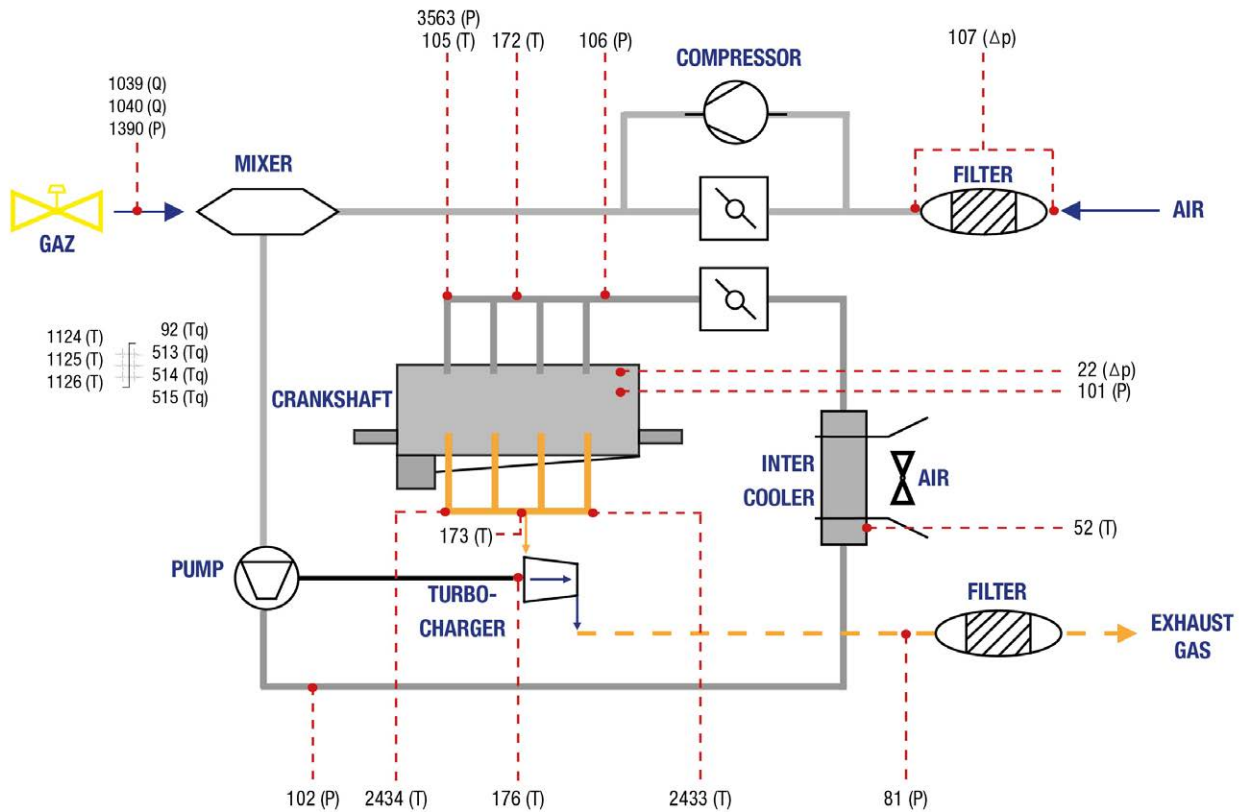

SPN	Description	PGN
107	Air inlet filter #1 differential pressure (first or sole filter).	FEF6
52	Inter-cooler temperature.	FE E
106	Air inlet pressure (at inlet to intake manifold or air box).	FEF6
102	Intake manifold #1 pressure (boost pressure measured downstream of turbo compressor).	FEF6
3563	Intake manifold #1 absolute pressure.	FDD 0
105	Intake manifold #1 temperature.	FEF6
172	Air inlet temperature.	FEF5
22	Extended crankcase blow-by pressure (differential pressure across a venturi).	FEEF
101	Crankcase pressure.	FEEF
1039	Trip Fuel (gaseous) (fuel consumed during all or part of a run).	FEAF
1040	Total Fuel used (gaseous) over the engine life.	FEAF
1390	Fuel valve 1 inlet absolute pressure.	FE8B
2433	Exhaust gas temperature - Right manifold.	FE07
2434	Exhaust gas temperature - Left manifold.	FE07
173	Exhaust gas temperature (alternative to 2433 + 2434).	FEF6
176	Turbocharger oil temperature.	FE E
81	Diesel particulate filter (trap) inlet pressure.	FEF6
92	Engine percent load at current speed. The ratio of actual engine percent torque (indicated) to maximum indicated torque available at the current engine speed, clipped to zero torque during engine braking .	F004
513	Actual percent torque. The calculated output torque of the engine. The data is transmitted in indicated torque as a percent of reference engine torque. The engine percent torque value is not negative and includes the torque developed in the cylinders required to overcome friction.	F004
514	Nominal friction (percent of reference torque). Torque that compensates the engine and pumps losses.	FED F
1124	Alternator winding 1 temperature.	FEA7

1125	Alternator winding 2 temperature.	FEA7
1126	Alternator winding 3 temperature.	FEA7

OIL AND COOLANT CIRCUITS

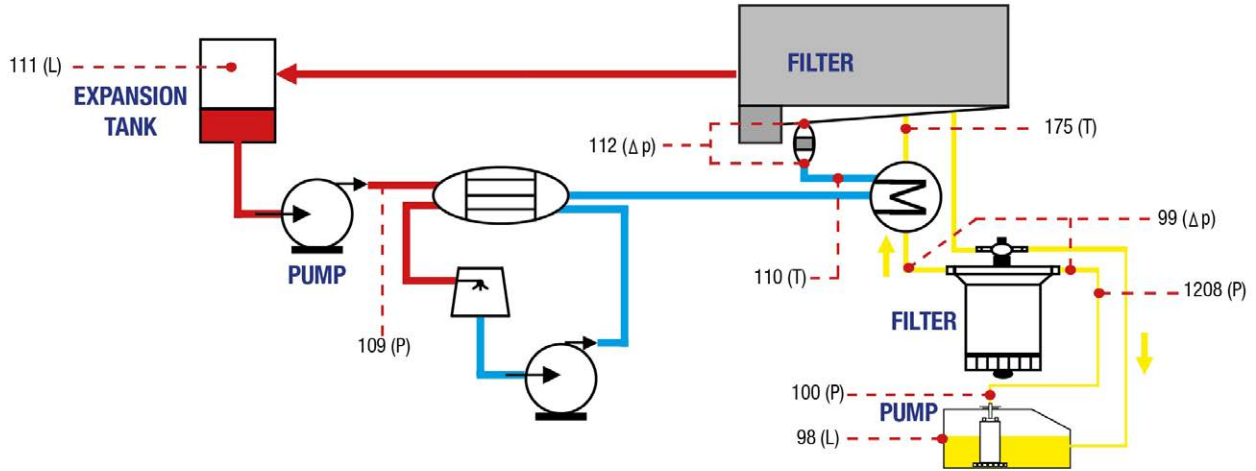

SPN	Description	PGN
98	Oil level (ratio of sump current volume to required volume).	FEEF
99	Oil filter differential pressure.	FEF C
100	Oil pressure.	FEEF
175	Oil temperature 1.	FEE E
1208	Oil pressure (upstream the pre-filter).	FE92
109	Coolant pressure.	FEEF
110	Coolant temperature	FEE E
111	Coolant level (ratio of current volume to total volume).	FEEF
112	Coolant filter differential pressure.	FEF6

These measurements are shown in **i4Gen Suite Software/Scada/Engine meters**. A measurement not sent by the ECU is shown as "...":

Note: To get the measurements through Modbus TCP, refer to [Modbus TCP/IP](#).

FAULTS

The module can monitor diagnostic messages (DM1) from the ECU. Only relevant diagnostic messages are taken into account and used in the module fault/alarm system. The module can understand and interpret messages for display, process, and protection.

When you activate the internal module RESET (**[SHIFT+INFO]** button or remote reset), the module sends a reset message (DM3) to the ECU. If the diagnostic message is not sent by the ECU for more than 3s, the corresponding fault/alarm is automatically reset to Off.

Each of the following J1939 messages/alarms can be configured to trigger one of the module protections:

J1939 message	Control in i4Gen Suite Software		Message description (ECU internal threshold)
High speed	[3104]	CT speed +	Engine speed above least severe high threshold.
Very high speed	[3105]	CT speed ++	Engine speed above the most severe high threshold.
High water temperature	[3106]	CT Cool Temp. +	Coolant temperature above least severe high threshold.
Very high water temperature	[3107]	CT Cool Temp ++	Coolant temperature above the most severe high threshold.
Low oil pressure	[3108]	CT Oil Press -	Oil pressure below least severe low threshold.
Very low oil pressure	3109	CT Oil Press --	Oil pressure below the most severe low threshold.
Malfunction "lamp"	3110	CT Malfunction	Message in presence of an emission-related trouble
Protection "lamp"	3111	CT Protection	Trouble is most probably not electronic subsystem related. E.g., coolant temp. may exceed temp. range.
Amber "lamp"	3112	CT Amber	Trouble where the engine need not immediate stop.
Red "lamp"	3113	CT Red	Severe enough trouble for the engine to stop.

All thresholds are those set in the ECU. In addition of these known diagnostic messages, the module shows the latest five unmanaged SPN (what is wrong)/FMI (Failure Mode Identifier, i.e. error type) combinations it has received with the diagnostic message (DM1). These SPN/FMIs are backed up in registers:

Register		Description
0664 0665 0666	J1939 SPN LO 1 J1939 SPN HI 1 J1939 FMI 1	Latest NSP/IMF received by the module.
0667 0668 0669	J1939 SPN LO 2 J1939 SPN HI 2 J1939 FMI 2	Second latest NSP/IMF received by the module.
0670 0671 0672	J1939 SPN LO 3 J1939 SPN HI 3 J1939 FMI 3	Third latest NPS/IMF received by the module.
0673 0674 0675	J1939 SPN LO 4 J1939 SPN HI 4 J1939 FMI 4	Fourth latest NPS/IMF received by the module.
0676 0677 0678	J1939 SPN LO 5 J1939 SPN HI 5 J1939 FMI 5	Fifth latest NPS/IMF received by the module.

SPN LO corresponds to LSB, SPN HI to MSB

Note: In any case, a fault/alarm is activated on reception of an unknown SPN/FMI if the Red [3113]/ Amber [3112] control has been set. It is deactivated by Reset.

CONTROLS

S P N	Description	Details	P G N
89 8	Requested speed	Engine speed which the engine is expected to operate at if the speed control mode is active.	0
97 0	Start-Stop	Engine shutdown switch.	F0 01
28 81	Frequency selection	Ability to switch the rated speed. Switched on a state transition while engine speed is 0. 50/60Hz (CM570 and PGI) or sources given through a nibble (e.g. see ECU8 section in Appendices/ECU J1939/MTU).	F D C B

CAN BUS GOOD PRACTICES

This chapter describes rules to be used to ensure reliable CAN communication. These rules must be applied to all CAN communications, including **CRE-Link®** and ECU/remote I/O CAN bus.

CRE TECHNOLOGY recommends to always use a shielded cable to connect CAN bus.

CABLES

⚠ WARNING
RISK OF EQUIPMENT DAMAGE
Switch off the unit before plugging or unplugging the CAN bus connector or disconnecting the wires.
Failure to follow this instruction can damage the CAN transmitter/receiver.

Cables used must be selected to respond to CAN bus specificities. Always use shielded twisted wire pairs. Deploy the CAN bus (no mesh, ring or star topology) as shown below:

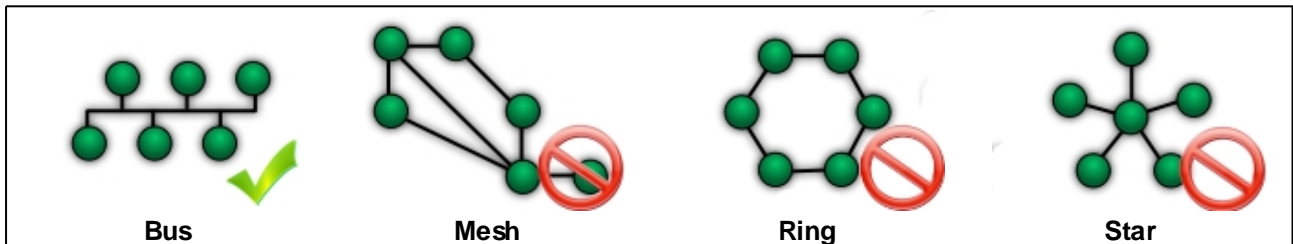

Both ends of the CAN bus must be terminated with a 120 Ω resistor. The module has a 120 Ω resistor for this purpose. Wiring the terminal RES to CAN H will link CAN L and CAN H with a resistor.

The next figure gives the example of three units connected through a CAN bus. Do NOT install any resistor nor link the terminal RES and CAN H together in the middle unit.

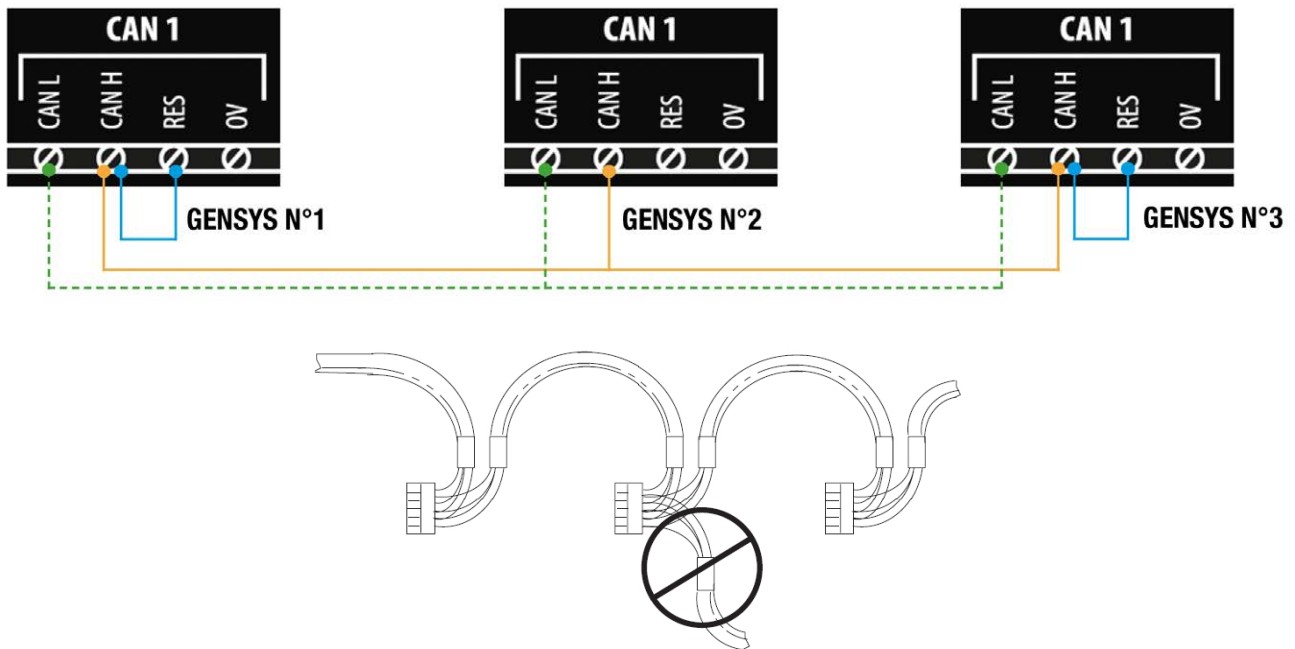

⚠ WARNING
RISK OF EQUIPMENT DAMAGE
Do not, in any cases, connect 0V pin to - power supply pin.
Failure to follow this instruction may damage the CAN transmitter/receiver and the controller itself.



CRE TECHNOLOGY provides a complete range of products aimed at installing your CAN bus (cords, wires, connectors...). Please contact your local **CRE TECHNOLOGY** distributor to help you to choose equipment that fits your needs.

MAXIMUM LENGTH & BIT RATE

The maximal length of a CAN bus depends mostly on the communication speed, but also on the quality of wires and connectors used.

The following table shows the maximal length of a CAN bus depending on the bit rate:

Bit rate (Kbits/s)	10	20	50	125	250	500	800
Maximal length (m)	5000	2500	1000	500	250	100	50

The next table lists the standard bit rate of each CAN protocol that can be used by a **CRE TECHNOLOGY** unit:

Bus	Protocol	Bit rate (Kbits/s)	Note
CAN1	CRE-Link®	125	Fixed.
CAN2	CANopen	125 (default)	Can be selected between 125/250/500/1000kbit/s (By i4Gen Suite Software or modification by variable number).
	J1939	250 (default)	Switch automatically to the right speed when selecting an ECU type.

WEBSITE

ACCESS

MENU TREES

During navigation on the PC, press the **ESC** button to return to the parent menu of the page displayed in the browser.

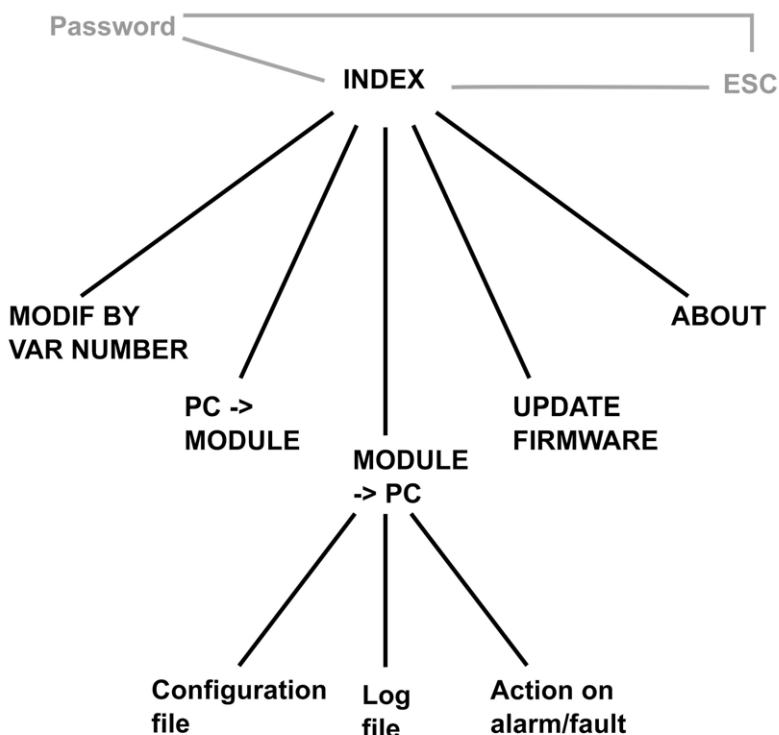

ACCESS TO THE WEBSITE

1. Connect a PC to the module via an Ethernet connector.
2. Use a web browser such as Firefox or Internet Explorer for example.
3. Enter the IP address (factory setting: <http://192.168.11.1>), or the module Hostname.
4. Enter the module password when the **Password** page appears (see chapter [Password](#)).

CORE MODULE

For modules without display, it is not possible to connect to the product if the IP address of the product is unknown.

In this case, it is therefore possible to reset the IP address to its default value (192.168.11.1) by doing the following :

- Switch off the product by removing the power supply
- Press the button dedicated to this function: Button located at the bottom left on the back of the product (side without screen printing)
- Power the product while holding the button

FILE TRANSFER

ADVICE	
	USEFUL INFORMATION
	<ul style="list-style-type: none"> ▪ Adjustment tip ▪ Using the module
	Failure to comply with these recommendations may cause the module to malfunction.

File transfer is only possible when the engine is stopped.

These files can be transferred from or to the module.
For this, use **i4Gen Suite Software** or the embedded website.

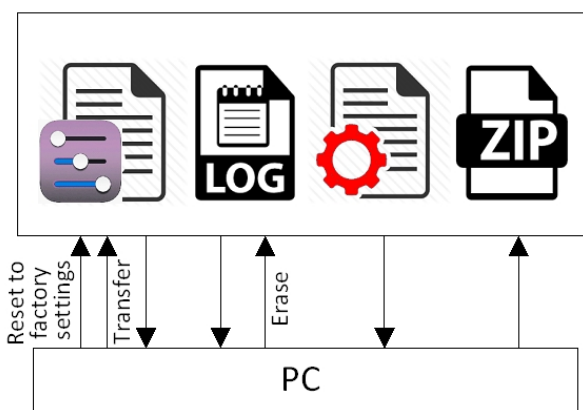

Note: CRE TECHNOLOGY strongly recommend using i4Gen Suite Software to edit module settings to prevent any kind of error with manual editing in the configuration file.

FILE TRANSFER MODULE → PC

This page allows to download a file from the module to the PC:

- Configuration file.
- Log file.
- List of actions on alarms/faults.

Configuration File

To view the current module configuration in a web browser, select **Configuration File**.
In the browser, save this file in .txt format.

Data Backup File (log)

To display the module log in a web browser, select **Log file** and save this file in .txt format.

List of Actions on Alarms/Faults

By selecting "**Alarm/fault effect**", a file containing all potential alarms and faults and their usage is downloaded.

Example:

S/N:0114A0001
 Type:A56Z0
 Version:v1.00
 Bootversion:v1.00
 Date:28/06/15
 Hour:12h25m21s

***** Alarm/fault effect *****

- 0 : Desactive
- 1 : Defaut Gen electrique
- 2 : Defaut Bus electrique
- 3 : Alarme
- 4 : Defaut non critique
- 5 : Defaut critique
- 6 : Help+Defaut non crit
- 7 : Help+Defaut Gen.Elec
- 8 : Statisme

Potentiel Alarm./Def.	Parametre actuel	ANSI C37-2
V00600 Etat CAN1	<-- V03052 = 8	
V00602 CAN2 etat	<-- V03053 = 0	
V04200 Survitesse	<-- V02352 = 3	12
V04201 Sous vitesse	<-- V02355 = 0	14
.....		

FILE TRANSFER PC → MODULE

This page allows you to send a configuration file, or a language file.
 When the transfer operation is complete, the transfer result is displayed on the screen.

Note:

- *Before making a change to the module configuration, it is recommended to save the current configuration. File transfer is only possible when the Generator is stopped (The module must be in the "Waiting" power state).*
- *Reset to factory settings must be done using **i4Gen Suite Software** (password level 2 mandatory).*

FIRMWARE UPDATE

PREREQUISITES

1. Upgrading software is done via an Ethernet connection. It is mandatory to have a PC connected to the module (Use an Ethernet cable from module to PC without using LAN).
2. Stop the Generator (The module must be in the **Waiting power** state).
3. Save the current configuration as a text file. Otherwise the default settings will be enforced (except for the Ethernet settings).
4. Disconnect all terminals, except the power supply and Ethernet connections.

Note: Be sure there is no Modbus request on the module during upgrading.

START UPGRADE

1. Connect to **i4Gen Suite Software/System/PC transmit/receive** or to module website.
2. Select **Update firmware** and browse the archive.
3. Click on the **Update** button.
4. Alarm/fault LEDs blink and state is displayed on LCD screen.
5. Wait until **Update firmware successful** shows.
6. If needed, restore the settings from the text file previously saved.

*Note: The module will restart during the update process. Please wait for the "**Update firmware successful**" message before starting to use the module (about 2 minutes).*

APPENDICES

ECU J1939

CATERPILLAR



Manufacturer [3100]	ECU [3101]	Air + Exhaust + Alternator	Oil and coolant
[8]	GENERIC [0]		
	A4E2 (C4.4 C6.6)[1]	91 515 250 157 183 168 158 247	102 105 106 172 92 513

ECU [3101]	Speed	Start/Stop	Speed selection
GENERIC [0]	x	-	-
ADEMA4E2 (C4.4 & C6.6) [1]	x	-	-

CUMMINS



TECHNICAL DOCUMENTATION

Manufacturer [3100]	ECU [3101]	Fuel & ECU	Air + Exhaust + Alternator	Oil and coolant
(1) [6]	GENERIC [0]			
	QSX15G8(CM570) [1]	157 175 183 168 108	102 105 513	
	CM850 [2]			
	QSB5 (PGI 1.1) [3]	91 ^a 1242 ^b 512 ^a 515 ^a 2432 ^b 157 ^b	102 105 92 ^a 513 514 ^a	100 1208 ^b 110 111b
	QSB7 (PGI 1.1) [4]	174 ^a 182-3-4 ^a 247-50 168 108 97		
	QSL9 (PGI 1.1) [5]	Id+ 512 ^b 515 ^b 184 ^b 94 ^b 174 ^b 1136 ^b	Id + 92 ^b 101 ^b 173 ^b 514 ^b	Id + 175 ^b 109 ^b
	QSM11 (PGI 1.1) [6]	91 ^a 1242 ^b 512 ^a 515 ^a 2432 ^b 175 182 250 183 168 108 97 ^b 247	102 105 92 ^a 513 514 ^a	100 1208 ^b 110 111b
	QSX15 [7]	91 ^a 512 ^a 515 ^a 175 182 ^a 250 ^a 183 168 108 247 ^a	102 105 92 ^a 513 ^a 514 ^a	100 110
	QSK19 (PGI 1.1) [8]	91 ^a 1242 ^b 512 ^a 515 ^a 2432 ^b 94 97 ^b 157 ^b 174 ^b 182 ^b 3-4 ^a 247- 50 ^b 168 108	102 105 101 92 ^a 513 514 ^a 22 ^a	100 1208 ^b 110 111b 109
	QSK38 (PGI 1.1) [9] QSK50 (PGI 1.1) [10] QSK60 (PGI 1.1) [11]	91 ^a 1242 ^b 512 ^a 515 ^a 2432 ^b 157 ^b 174 175 ^b 94 182 ^b 250 ^b 183 184 ^a 168 108 97 ^b	102 105 101 513 514 ^a 22 ^a 92 ^a	100 1208 ^b 110 111b 109

1. ECU Cummins can contain different firmwares depending on their source:
 - a) Industrial model only
 - b) G Drive only
2. Cummins 109G ECU may not support J1939 speed control. ECU with Cummins G Drive firmware should support J1939 speed control.

ECU [3101]	Speed	Start/Stop	Speed selection
GENERIC [0]	x	x	x
QSX15-G8 (CMS570) [1]	x	x	x
CM850 [2]	x	-	x
QSB5 (PGI 1.1) [3]	x	-	x
QSB7 (PGI 1.1) [4]	x	-	x
QSL9 (PGI 1.1) [5]	x	-	x
QSM11 (PGI 1.1) [6]	x	-	x
QSX15 (CMS570) [7]	x	x	x
QSK19 (PGI 1.1) [8]	x	-	x
QSK38 (PGI 1.1) [9]	x	-	x
QSK50 (PGI 1.1) [10]	x	-	x
QSK60 (PGI 1.1) [11]	x	-	x

DETROIT DIESEL



Manufacturer [3100]	ECU [3101]	Fuel and ECU	Air + Exhaust + Alternator	Oil and coolant
[11]	GENERIC [0]			
	DDEC III [1]			
	DDEC IV [2]	91 512-5 188-9 174 94 157 171 182 247-50 183-4 166-8 108 158	52 102 22 101 105 106 172 107 173 176 92 513 514	98 99 100 175 109 110 111 112
	DDEC X [3]	91 512 2432 188 189 166 174 94 97 157 171 182 250 183 18 168 1136 108 158 247		

ECU [3101]	Speed	Start/Stop	Change speed
GENERIC [0]	-	-	-
DDEC III [1]	-	-	-
DDEC IV [2]	-	-	-
DDEC X [3]	-	-	-

DEUTZ FAHR



Manufacturer [3100]	ECU [3101]	Fuel & ECU	Air + Exhaust + Alternator	Oil and coolant
[9]	GENERIC [0]			
	EMR [1]	91 512 188 183 247	102 92 513	100 110
	EMR2 [2]	91 512 183-4-8 174 158 108 247	102 105 92 513	98 100 110 111
	EMR3 [3]	91 512 2432 183 174 94 111 158 108 247	107 102 105 92 513 514	100 110 111

ECU [3101]	Speed	Start/Stop	Speed change
GENERIC [0]	x	-	-
EMR [1]	x	-	-
EMR2 [2]	x	-	-
EMR3 [3]	x	-	-

IVECO



Manufacturer [3100]	ECU [3101]	Fuel & ECU	Air + Exhaust + Alternator	Oil and coolant
[4]	GENERIC [0]			
	NEF (EDC) [1]	91 512-5 2432 183-4 250 97 174 158 108 247	102 105 173 81 92 513 514	100 175 110 100 110
	CURSOR [2]			
	CURSOR9 (EDC) [3]			
	CURSOR11 [4]			

ECU [3101]	Speed	Start/Stop	Speed change
GENERIC [0]	x	-	-
NEF (EDC) [1]	x	-	-
CURSOR [2]	x	-	-
CURSOR9 (EDC) [3]	x	-	-
CURSOR11 [4]	x	-	-

JOHN DEERE



Manufacturer [3100]	ECU [3101]	Fuel & ECU	Air + Exhaust + Alternator	Oil and coolant
[7]	GENERIC [0]			
	JDEC [1]	91 512 515 2432 182 250 183 184 94 157 174 158 247	107 52 106 102 105 101 173 176 81 92 513 514	98 100 175 109 110 111 112

ECU [3101]	Speed	Start/Stop	Speed change
GENERIC [0]	x	-	-
JDEC [1]	x	-	-

MTU



Manufacturer [3100]	ECU [3101]	Fuel & ECU	Air + Exhaust + Alternator	Oil and coolant
[10] Voir Appendice MTU	GENERIC [0]			
	ADEC-2000 [1]	94 158 247 171 174 188 189 166 1136 1387 1388	52 102 2433 2434 1124-5-6	100 110 175
	ADEC-4000 [2]	247		
	ECU8 Smart conn[3]	515 94 158-66 182-3-8-9 247- 50 1136	105 3563	100 109 110
	ECU8 + SAM [4]			

ECU [3101]	Speed	Start/Stop	Speed adjustment
GENERIC [0]	-	x	x
ADEC-2000 [1]	-	x	x
ADEC-4000 [2]	-	x	x
ECU8 + Smart Connect [3]	x	x	x
ECU8 + SAM [4]	-	x	x

ADEC

The SAM (Service and Automation module) is associated with the ADEC 2000 or ADEC 4000. The set is referred to as the ECU7.

Disconnect X13 to turn off the power. Insert the CCB2 card into SAM slot #3.

The ADEC ECU, SAM and the module communicate via 2 CAN buses: a CAN bus between the SAM and the ADEC with a proprietary protocol, a CAN bus between the module and the SAM with the J1939 protocol. The SAM includes a termination resistor.

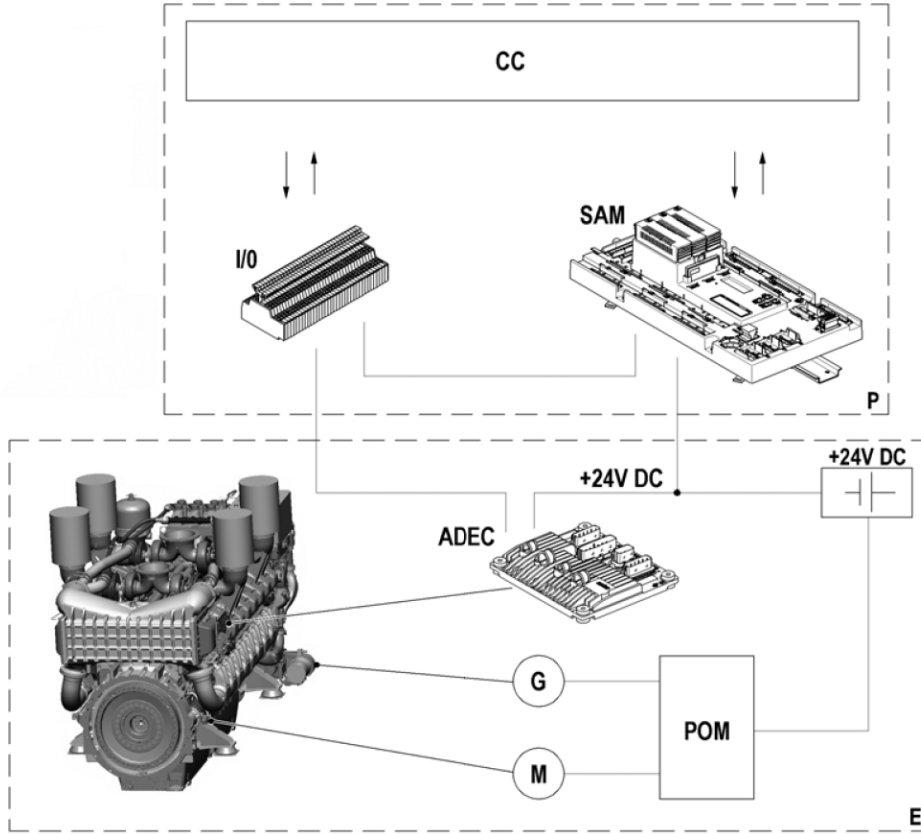

The ADEC controls, among other things, the engine speed.

Typical ADEC and SAM connection:

Signal	ADEC X1	Cabinet	SAM X23 connecteur
CAN High	33	X7-2	2
CAN Low	18	X7-1	1
CAN ground	34	X7-3	3
Speed out +		X2-	
Speed out -		X2-	

ECU8

Smart Connect is used for:

- select the origin of the speed control via an 8 position selector
- set droop frequency and slope

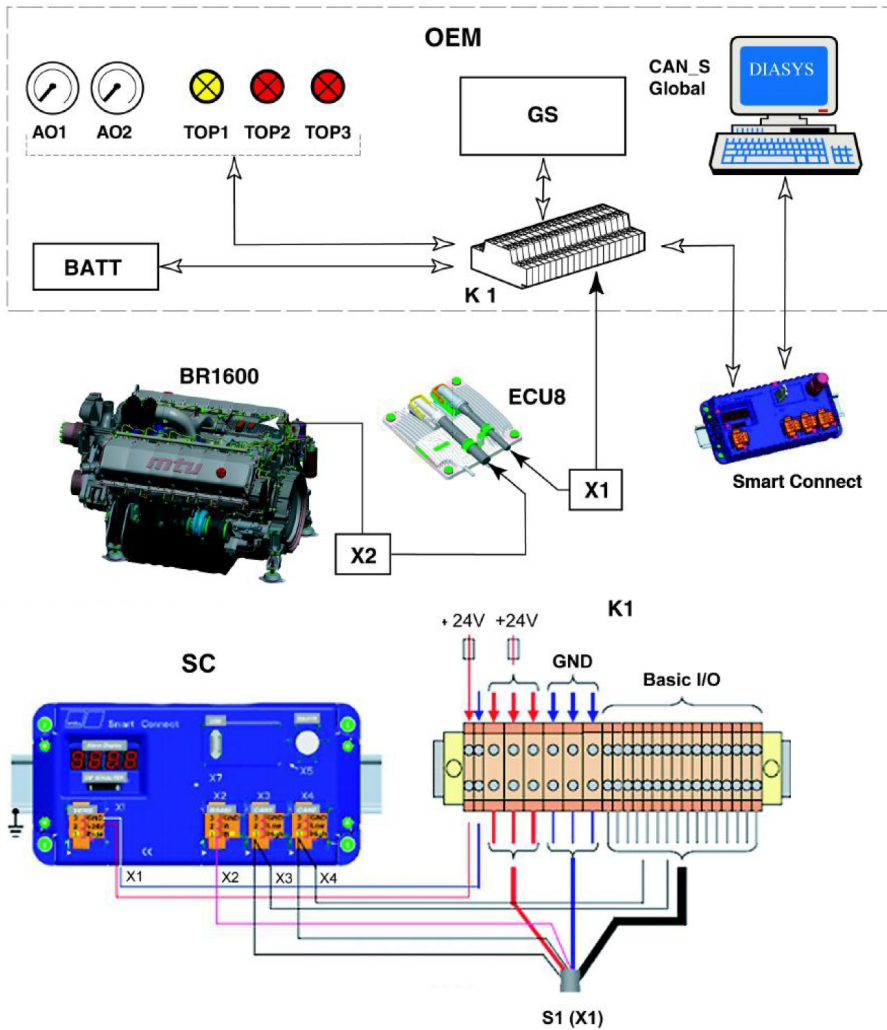

Via the K1 connection box, the ECU8, the Smart Connect and the module are connected: a CAN bus between the Smart Connect and the ECU8 with a proprietary protocol, a CAN bus between the Smart Connect and the module with the J1939 protocol. X4 is the connector supporting the J1939 to connect to the module.

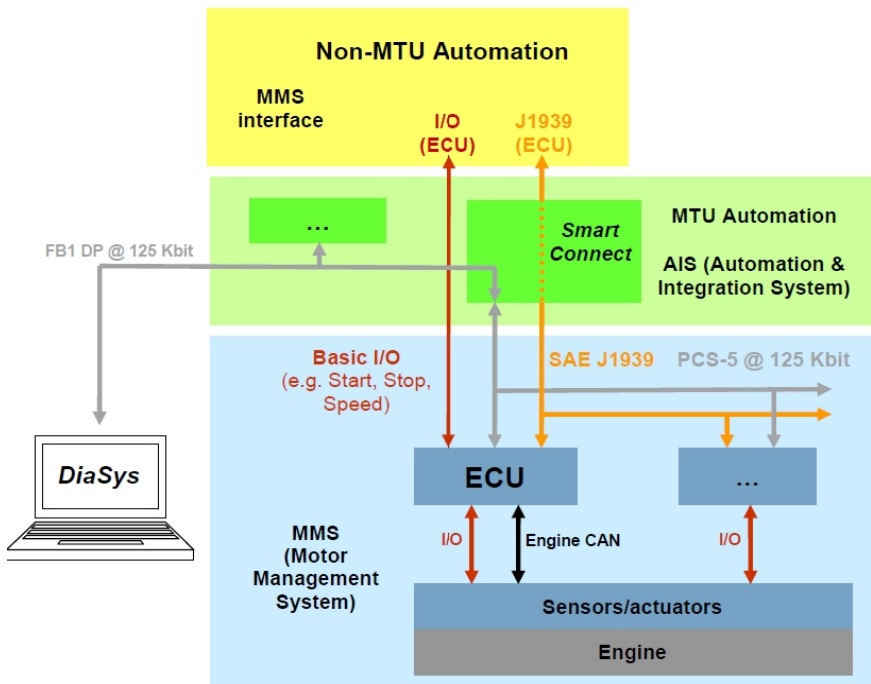

PERKINS



Manufacturer [3100]	ECU [3101]	Fuel & ECU	Air + Exhaust + Alternator	Oil and coolant
[3]	GENERIC [0]			
	1100 A4E	91 515 188 174 250 183 247	102 105 92 513	100 110

ECU [3101]	Speed	Start/Stop	Speed change
GENERIC [0]	x	-	-
1100 (A4E)	x	-	-

SCANIA



Manufacturer [3100]	ECU [3101]	Fuel & ECU	Air + Exhaust + Alternator	Oil and coolant
	GENERIC [0]			
	S6 (DC16-45A) [1]	91 512 188 183 184 247	102 105 92 513 514	100 110 111

ECU [3101]	Speed	Start/Stop	Speed selection
GENERIC [0]	x	x	-
S6 (DC16-45A) [1]	x	x	-

VOLVO PENTA



Manufacturer [3100]	ECU [3101]	Fuel & ECU	Air + Exhaust + Alternator	Oil and coolant
[2]	GENERIC [0]			
	EMS2 [1]	94 182 250 247	102 172	100 175 110
	EDC4 [2]	Same as Deutz EMR2	Same as Deutz EMR2	Same as Deutz EMR2
	94xGE [3] 124xGE [4]	91 512 188 1013 182 94 250 183 97 158 247	102 105 92 513	100 175 110 111
	1640-2GE [5]	91 512 188 1013 182 94 250 183 158 247	102 105 92 513	100 175 110 111
	1643GE [6]	91 512 188 1013 182 94 250 183 158 247	102 106 107 173 92 513 514	100 175 110 111
	D6 [7] D7 [8]	91 512 188 1013 182 94 250 183 97 158 247	102 105 92 513	100 110 111
	D13GE-Tier3 [9]	91 512 188 1013 182 94 250 183 97 158 247	102 105 92 513	100 175 110 111

ECU [3101]	Speed	Start/Stop	Speed change
GENERIC [0]	x	-	-
EMS2 [1]	x	x	x (Multi-speed engine)
EDC4 [2]	x	-	-
94xGE [3]	x	x	x
124xGE [4]	x	x	-
1640-2GE [5]	x	x	x
1643GE [6]	x	x	x
D6 [7]	x	x	-
D7 [8]	x	x	-
D13GE-Tier3 [9]	x	x	x

TROUBLESHOOTING

To get a history of alarms-faults, stop the Generator, connect to ***i4Gen Suite Software/System/PC transmit/receive/Download log file from module***, and click **Download**.

To restore factory settings into ***i4Gen Suite Software***, navigate to ***i4Gen Suite Software/System/PC transmit/receive/Reset factory settings***, and click **Reset**.

Message "Sensor lost" fault on start

In ***Configuration/Engine/Control settings***, check that the speed measurement origin is accurate (Speed measure = magnetic or alternator or J1939).

If it originates in the alternator, check the voltage presence on terminals Gen L1, L2, L3, N.

If it originates in a magnetic pick-up, check that the engine speed increases up to 1500rpm.

If the speed does not reach this value on time (the engine stops), increase the "sensor lost" time-out [4203] (default value 5.0s). This time-out is set in ***i4Gen Suite Software/Configuration/Time-out and delays***.

Message "Oil pressure" fault on start

Check the related connections.

Check the related settings: mainly, delays and directions of digital/analog inputs.

Message "Isolated product"

Check the related connections, including the one of internal resistor (jumper).

Check the related settings: count of generators, number of each Generator.

Message "Missing product"

Check the other products. One of them is not supplied or disconnected.

Message "Missing master"

Check the **MASTER COMPACT/MASTER 1B COMPACT/BTB COMPACT** products. One of them is not supplied or disconnected.

Message "Unknown product"

Check the other products. One of them is not compatible.

Message "Mismatch version"

Check the other products. One of them uses a version which is not compatible.

No J1939 communication

Check that the ECU is powered.

Check that the configuration correspond to the engine/ECU.

Check that the wiring is correct.

Power cycle module and ECU.

Check that the ECU and its settings are consistent with the J1939 standard.

Note: Some ECUs do not provide information if the engine is stopped. Try starting the engine.

Message "Breaker" fault

Check the type of breaker against the selection in ***i4Gen Suite Software/Configuration/Outputs***.

Stop the other generators.

Make sure the digital input Gen breaker feedback is connected.

Start the generators in **MAN** mode (or just press ). Make sure the breaker LED turns on (green);

otherwise, increase the "breaker feedback" time-out [2304] (default value 5.0s).

The engine starts but runs above/below nominal speed.

Check the wiring.

Check the fuel supply.

Check the speed output.

Cannot connect with PC

Consider deactivating the firewall and adding an Anti-virus exception.

Check the network wiring, see [Network](#).

Error Messages When Transferring a File to the Module

Note: "..." indicate a variable number, a label number or a text number according the error message. It will help you to locate your error in your configuration file.

ERROR 001: Only when GENSET is STOP

File transfer between computer and the unit should be done only when all conditions below are met i.e. when engine is stopped.

ERROR 002: Unknown file type

The file type sent is unknown. Check the selected file.

ERROR 004: Write data or checksum error

ERROR 008: Update failed. Please restart update.

Writing memory error during update process. Restart module update.

ERROR 011: No write right on variable

Access to this variable is not allowed. Only parameter can be modified.

ERROR 012: No write right on label

Access to this label is not allowed. Check your configuration file.

ERROR 013: Text doesn't exist.

Access to this text is not possible because it does not exist. Check compatibility of the version/type of the module and the configuration file.

ERROR 014: No write right on Unit

Access to this unit is not allowed. Check your configuration file.

ERROR 015: Need password 2 to write on Variable

Actual password is not sufficient to access such configuration/control level.

ERROR 017: Configuration not allowing variable value

The actual setting of the module does not allow modifying this parameter with this value. Check your configuration file and the value of the parameter before sending again your configuration file.

ERROR 018: Variable out of range

The value of the parameter is out of range. Check your configuration file before sending again.

ERROR 019: Wrong value for variable

An unexpected value has been detected on this parameter. Check the value of the parameter before sending again.
Ex: a text character has been detected instead of a number.

ERROR 020: Unknown language file

The language file sent does not correspond to a language file for the module. Check the selected language file.

ERROR 021: Too many languages already downloaded

The maximum number of language supported by the module has been reached.

ERROR 022: Wrong language file version

The language file version is above the module version. Upgrade your module with the latest version available or catch the language file compatible with your module version.

ERROR 023: Label does not exist.

Modifying this label is not allowed. Check the label number before sending the configuration file again.

ERROR 024: Unit does not exist.

Modifying this unit is not allowed. Check the unit number before sending the configuration file again.

ERROR 025: Wrong accuracy value on (0,1,2 or 3)

The value of the accuracy is out of range. The value must be between 0 and 3.

ERROR 026: Wrong unit value on (from 0 to xxx)

The value of the unit is out of range. The value must be between 0 and xxx.

ERROR 027: No header in language file

No header or wrong header of the language file. Check the selected language file before send it again.

ERROR 028: No filename found or too long

No filename or filename is too long. The maximum size of a filename is 40 characters. Rename file and send it again.

ERROR 029: Wrong accuracy on parameter

The value of the modified parameter has not the right accuracy. Check the value of your parameter before sending again your configuration file.

Ex: Below, it is missing the digit a the tenth 5.00

V02205 5.0_ ESG amplitude +000.00+010.00V

*ERROR 030: Data out of range in **Easy Flex®***

The result of the operation is outside the range value of the output variable.

ERROR 031: Invalid TXT file version

The TXT file is not valid because it comes from a non-compatible firmware.

For example: TXT file from 1.xx version are only compatible with product using 1.xx version. TXT file from 2.xx version are only compatible with product using 2.xx version. Etc...

Warning

Warnings do not prevent the module to work but inform the user of a potential problem in its configuration file.

WARNING 001: Wrong size of label

WARNING 002: Wrong character entered in label

WARNING 003: Wrong size of text

WARNING 004: Wrong character entered in text

These advices indicate that entered labels/texts are too long or that a character is not supported by the module.

Invalid characters will be replaced by "?". The valid characters are the followings:

0123456789.-

ABCDEFGHIJKLMNOPQRSTUVWXYZ

!#\$()+/:;=][^_?*

abcdefghijklmnopqrstuvwxyz

The maximum size of a label is 14 characters and 28 characters for a text.

Modify labels/texts according to the rules above.

WARNING 005: Too many errors...

All errors/warnings messages could not be displayed. There are probably other problems in your configuration file. Solve displayed problems and send your configuration file again in order to display the additional error/warning messages.

WARNING 006: No unit specify on unit

WARNING 007: No value specify on parameter

WARNING 008: No text specify on text

WARNING 009: No label specify on label

These warnings indicate that no value has been filled inside the configuration file for a unit/parameter/text or label. The values will stay unchanged.

WARNING 011: Variable does not exist.

The parameter does not exist. Check compatibility of the version/type of the module and the configuration file.

STANDARDS FOR GENERATOR

ISO 8528-1 CLASSES AND POWER DESIGNATIONS

Various load-duration profiles are defined. Here is the correspondence between classes and powers:

Run	ISO designation	Conditions	Power designation	Conditions	Controller
Unlimited # of hours	PRIME RATING	Allowable average power output over a 24-hour period is 70% of the prime rating. 10% overload.	Prime Running Power (changing load).	Overload: max: 1 h over a 12-h period total: 25 h/ year.	GENSYS COMPACT PRIME
	CONTINUOUS RATING (base load rating)		Continuous operating power.	Fixed load.	ACGEN2.0 (no paralleling)
Limited # of hours	STANDBY RATING	Maximum 200 hours per year. Allowable average power output over a 24-hour period is 70% of the standby rating. No overload.	Emergency stand-by power (changing load).	25h/ year at 100%. No overload 200 h/year at 80%	TCGEN2.0 (no paralleling)
	MISSION-CRITICAL RATING	Maximum 500 hours per year. Allowable average power output is 85% of the nameplate rating.	Limited-time running power.	Fixed load.	

ISO 3046

- Part 1: Power: DBR (intermittent) and MCR (Max Continuous Rating).
The **COMPACT RANGE** offers the possibility to activate air conditioning and a cooling fan.
- Part 4: Speed governor

Governor performance classes	G1	G2	G3	G4
Speed droop	8%	5%	3%	By agreement
Regulation stages	P, PI or PID	P, PI or PID	PI or PID	PI or PID

NEC700 AND NFPA110

Start in static paralleling to meet the 10s time limit (NEC700). Type 10 as per NFPA110.

According to NFPA110, Black start is where the stored energy system has the capability to start the prime mover without using energy from another source. Such a Generator can be used to start a turbine.

NFA110 defines classes according to fuel tank autonomy; it requires that emergency power supply has a manual remote stop (A5.6.5.6). NFA110 fault list includes 15 signals (warning or shut-down).

CERTIFICATIONS

DECLARATION OF CONFORMITY



**DECLARATION UE DE CONFORMITE
EU DECLARATION OF CONFORMITY**



Cette Déclaration de Conformité est conforme à la norme européenne EN17050-1 :2004 "Critères généraux pour les déclarations de conformité des fournisseurs".

This Declaration of Conformity is suitable to the European Standard EN 17050-1:2004 "General criteria for supplier's declaration of conformity".

**Nous,
We, CRE Technology**

Adresse du fabricant : 130, Allée Charles Victor NAUDIN
Manufacturer's Address: Zone des Templiers - Sophia Antipolis
06410 BIOT
FRANCE

déclarons sous notre seule responsabilité, que les produits délivrés:
declare under our sole responsibility that the products as originally delivered:

Nom du produit : SYNCHRO Compact HMI
Product Name: SYNCHRO Compact CORE

Référence produit : A56-SYNCHRO-00-x (HMI)
Regulatory Model: A56-SYNCHRO-10-x (CORE)

Version(s) produit : All
Product Version:

satisfont aux exigences essentielles des Directives Européennes ci-dessous et portent en conséquence le marquage CE :
Comply with the essential requirements of the following applicable European Directives, and carries the CE marking accordingly:

*Low Voltage Directive 2014/35/EU
EMC Directive 2014/30/EU*

CEM/EMC	Standard	Date	Description
	EN61326-1 CISPR11 EN55011 EN55022	2013 2010 + A1 (2011) 2012	EMC general requirements – Industrial environment - class A
	EN61000-4-2	2009	Electrostatic Discharges
	EN61000-4-3	2006 + A2 (2010)	Radiated, RF, electromagnetic field immunity test
	EN61000-4-4	2013	Electrical Fast Transients
	EN61000-4-5	2014	Surge immunity test
	EN61000-4-6	2014	Conducted disturbances immunity
	EN61000-6-2	2006	Generic standards. Immunity for industrial environments
	EN61000-6-4	2010	Generic standards. Emissions for industrial environments
Sécurité/Safety	Standard	Date	Description
	EN60950	2013	Information technology equipment. Safety. General requirements

Cette Déclaration de Conformité s'applique aux produits listés ci-dessus et placés sur le marché après le:
This DoC applies to above-listed products placed on the market after:

June 28, 2018

SIGNATURE

**BIOT – France for CRE technology
Responsable Qualité
Quality Manager**

CRE Technology - Allée Charles Victor NAUDIN - Zone des Templiers, Sophia Antipolis - 06410 BIOT - FRANCE
Tél: +33 (0) 4 92 38 86.82 / Fax: +33 (0) 4 92 38 86.83
SARL au Capital de 1000 Euros - RCS Antibes 488 625 583 - TVA : FR 54 488 625 583

ISO CERTIFICATE - 2015



Certificat

Certificate

N° 2009/33725.3

AFNOR Certification certifie que le système de management mis en place par :
AFNOR Certification certifies that the management system implemented by:

CRE TECHNOLOGY

pour les activités suivantes :
for the following activities:

CONCEPTION, FABRICATION, FORMATIONS ET SERVICES ASSOCIES
A LA COMMERCIALISATION DE PRODUITS DE CONTROLES ET DE PROTECTION
POUR LES GROUPES ELECTROGENES.

DESIGN, MANUFACTURING, TRAINING & SERVICES RELATED TO THE SALE
OF CONTROL AND PROTECTION PRODUCTS FOR POWER GENERATORS.

a été évalué et jugé conforme aux exigences requises par :
has been assessed and found to meet the requirements of:

ISO 9001 : 2015

et est déployé sur les sites suivants :
and is developed on the following locations:

130 Allée Charles Victor Naudin Sophia Antipolis FR-06410 BIOT

Ce certificat est valable à compter du (année/mois/jour)
This certificate is valid from (year/month/day)

2017-12-12

Jusqu'au
Until

2020-12-11

Ce document est signé électroniquement. Il constitue un original électronique à valeur probante.
This document is electronically signed. It stands for an electronic original with probatory value.

Franck LEBEUGLE
Directeur Général d'AFNOR Certification
Managing Director of AFNOR Certification



Flasquez ce QR Code
pour vérifier la validité
du certificat

Ce certificat électronique, consultable sur www.afnor.org, fait foi en l'absence de sa certification de l'organisme. The electronic certificate, available at www.afnor.org, stands in lieu of the original. AFNOR Certification (CERTIFC) n° 0001. Certification de Systèmes de Management. Période d'expiration: voir www.afnor.org.
GDFIAC, association n° 8001, Management Systems Certification. Siège social: 11, rue François de Pressensé, 93571 La Plaine Saint-Denis Cedex. AFNOR est une marque déposée. AFNOR is a registered trademark. CERTIFC 0001/1/2014

11 rue François de Pressensé - 93571 La Plaine Saint-Denis Cedex - France - T. +33 (0)1 41 62 80 00 - F. +33 (0)1 49 17 90 00
SAS au capital de 18 187 000 € - 479 076 002 RCS Bobigny - www.afnor.org



[Download the certification](#)

SOFTWARE VARIABLES



SOFTWARE VARIABLES

CRE TECHNOLOGY
130, allée Charles-Victor Naudin
Zone des Templiers - SOPHIA ANTIPOLIS
06410 BIOT - FRANCE
Phone: + 33 (0)4 .92.38.86.82
www.cretechnology.com
info@cretechnology.com

COPYRIGHT © CRE TECHNOLOGY. ALL RIGHTS RESERVED.

List of variables

Controller dynamic settings		81
Speed control		81
Amplitude (2205)		81
Offset (2206)		81
Droop (frequency) (2204)		81
Speed output inversion (2212)		81
Dead band (3650)		81
Frequency pulse divider (3652)		81
AVR control		82
AVR Amplitude (2251)		82
AVR Offset (2252)		82
Droop (voltage) (2250)		82
AVR signal output inversion (2254)		82
Dead Band (3651)		82
Voltage pulse divider (3653)		82
Synchronization PID		83
Frequency		83
Frequency Global Gain (2900)		83
Frequency Proportional Gain (2901)		83
Frequency Integral Gain (2902)		83
Frequency Derivate Gain (2903)		83
Phase		84
Phase Global Gain (2904)		84
Phase Proportional Gain (2905)		84
Phase Integral Gain (2906)		84
Phase Derivate Gain (2907)		84
Voltage		84
Voltage Global Gain (2950)		84
Voltage Proportional Gain (2951)		84
Voltage Integral Gain (2952)		85
Voltage Derivate Gain (2953)		85
Configuration		85
General		85
My number (2001)		85
Number of generator (2000)		85
Voltage system (2003)		85
Dead bus management (2002)		86
Generator		86
Nominal voltage (2102)		86
PT ratio (2100)		86
Bus		86
Nominal voltage (2152)		86
PT ratio (2150)		86
Engine		87
General		87
Number of poles pair (2202)		87
Speed setpoint (2207)		87
J1939		87
Manufacturer (3100)		87
ECU type (3101)		87
Inputs		87
Digital inputs		87
Input 1 (Customisable) (250)		87
Input 2 (Customisable) (251)		87
Input 3 (Customisable) (252)		88
Input 4 (Customisable) (253)		88
Input 5 (Customisable) (254)		88

Input 6 (Customisable) (255)	88
Input 7 (Customisable) (256)	88
Input 8 (Customisable) (257)	88
Input 9 (Customisable) (258)	88
Hysteresis DI	89
Hysteresis DI 1	89
Hysteresis 1 enable for DI (2769)	89
Timer (2777)	89
Direction (2785)	89
Hysteresis DI 2	89
Hysteresis 2 enable for DI (2770)	89
Timer (2778)	89
Direction (2786)	89
Hysteresis DI 3	90
Hysteresis 3 enable for DI (2771)	90
Timer (2779)	90
Direction (2787)	90
Hysteresis DI 4	90
Hysteresis 4 enable for DI (2772)	90
Timer (2780)	90
Direction (2788)	90
Hysteresis DI 5	90
Hysteresis 5 enable for DI (2773)	90
Timer (2781)	91
Direction (2789)	91
Hysteresis DI 6	91
Hysteresis 6 enable for DI (2774)	91
Timer (2782)	91
Direction (2790)	91
Hysteresis DI 7	91
Hysteresis 7 enable for DI (2775)	91
Timer (2783)	91
Direction (2791)	92
Hysteresis DI 8	92
Hysteresis 8 enable for DI (2776)	92
Timer (2784)	92
Direction (2792)	92
Analog inputs	92
Analog 1 (Customisable) (150)	92
Analog 2 (Customisable) (151)	92
Analog 3 (Customisable) (152)	92
Hysteresis AI	93
Hysteresis AI 1	93
Activating Hysteresis on Analog Input 1 (2657)	93
Low level threshold (2660)	93
Timer on low level threshold (2666)	93
High level threshold (2663)	93
Timer on high level threshold (2669)	93
Hysteresis Direction on Analog Input 1 (2672)	93
Hysteresis AI 2	93
Activating Hysteresis on Analog Input 2 (2658)	93
Low level threshold (2661)	94
Timer on low level threshold (2667)	94
High level threshold (2664)	94
Timer on high level threshold (2670)	94
Hysteresis Direction on Analog Input 2 (2673)	94
Hysteresis AI 3	94
Activating Hysteresis on Analog Input 3 (2659)	94
Low level threshold (2662)	94
Timer on low level threshold (2668)	95
High level threshold (2665)	95

	Timer on high level threshold (2671)	95
	Hysteresis Direction on Analog Input 3 (2674)	95
Outputs		95
Digital outputs		95
Status Digital Output 1 (4350)		95
Status Digital Output 2 (4351)		95
Status Digital Output 3 (4352)		95
Status Digital Output 4 (4353)		96
Status Digital Output 5 (4354)		96
Status Digital Output 6 (4355)		96
Relay outputs		96
Status Relay Output 1 (4356)		96
Status Relay Output 2 (4357)		96
Generator protections		96
Over/under frequency		96
Over frequency		96
Over frequency threshold (2400)		96
Over frequency timer (2401)		96
Over frequency control (2402)		97
Under frequency		97
Under frequency threshold (2403)		97
Under frequency timer (2404)		97
Under frequency control (2405)		97
Over frequency 2		98
Over frequency threshold 2 (2436)		98
Over frequency timer 2 (2437)		98
Over frequency control 2 (2438)		98
Under frequency 2		98
Under frequency threshold 2 (2439)		98
Under frequency timer 2 (2440)		98
Under frequency control 2 (2441)		98
Over/under voltage		99
Over voltage		99
Over voltage threshold (2406)		99
Over voltage timer (2407)		99
Over voltage control (2408)		99
Under voltage		100
Under voltage threshold (2409)		100
Under voltage timer (2410)		100
Under voltage control (2411)		100
Over voltage 2		100
Over voltage threshold 2 (2442)		100
Over voltage timer 2 (2443)		100
Over voltage control 2 (2444)		100
Under voltage 2		101
Under voltage threshold 2 (2445)		101
Under voltage timer 2 (2446)		101
Under voltage control 2 (2447)		101
Voltage unbalance		102
Voltage unbalance		102
Voltage unbalance threshold (2486)		102
Voltage unbalance timer (2487)		102
Voltage unbalance control (2488)		102
Voltage unbalance 2		102
Voltage unbalance threshold 2 (2489)		102
Voltage unbalance timer 2 (2490)		102
Voltage unbalance control 2 (2491)		103
Other protections		103
Analog inputs		103
Analog input 1		103
AN1 min/max (Customisable) (4206)		103

Analog input 1 threshold (2600)	103
Analog input 1 timer (2601)	103
Analog input 1 control (2602)	103
Analog input 1 threshold 2 (2603)	104
Analog input 1 timer 2 (2604)	104
Analog input 1 control 2 (2605)	104
Direction analog input 1 protection (2606)	105
Analog input 2	105
AN2 min/max (Customisable) (4207)	105
Analog input 2 threshold (2608)	105
Analog input 2 timer (2609)	105
Analog input 2 control (2610)	105
Analog input 2 threshold 2 (2611)	106
Analog input 2 timer 2 (2612)	106
Analog input 2 control 2 (2613)	106
Direction analog input 2 protection (2614)	107
Analog input 3	107
AN3 min/max (Customisable) (4208)	107
Analog input 3 threshold (2616)	107
Analog input 3 timer (2617)	107
Analog input 3 control (2618)	107
Analog input 3 threshold 2 (2619)	108
Analog input 3 timer 2 (2620)	108
Analog input 3 control 2 (2621)	108
Direction analog input 1 protection (2622)	109
Battery	109
Maximum battery voltage	109
Max. voltage battery threshold (2359)	109
Max. voltage battery timer (2360)	109
Max. voltage battery control (2361)	109
Minimum battery voltage	110
Min. voltage battery threshold (2356)	110
Min. voltage battery timer (2357)	110
Min. voltage battery control (2358)	110
Maximum battery voltage 2	110
Max. voltage battery threshold 2 (2377)	110
Max. voltage battery timer 2 (2378)	110
Max. voltage battery control 2 (2379)	111
Minimum battery voltage 2	111
Min. voltage battery threshold 2 (2374)	111
Min. voltage battery timer 2 (2375)	111
Min. voltage battery control 2 (2376)	111
Boost battery	112
Control boost battery (2388)	112
Low threshold boost battery (2386)	112
High threshold boost battery (2387)	112
Outputs	112
Max/Min speed output	112
Timer Min Max Speed output (2389)	112
Control Min Max Speed output (2390)	113
Max/Min AVR output	113
Timer Min Max AVR output (2391)	113
Control Min Max AVR output (2392)	113
CANopen	114
CANopen	114
CANopen	114
CAN2 baud rate (3051)	114
Error timer (3152)	114
Coupler 1	114
Coupler ID # 1 (3153)	114
CANopen IN 1 (3154)	114

	CANopen OUT 1 (3155)	114
Coupler 2		114
	Coupler ID # 2 (3156)	114
	CANopen IN 2 (3157)	115
	CANopen OUT 2 (3158)	115
Coupler 3		115
	Coupler ID # 3 (3159)	115
	CANopen IN 3 (3160)	115
	CANopen OUT 3 (3161)	115
Coupler 4		115
	Coupler ID # 4 (3162)	115
	CANopen IN 4 (3163)	115
	CANopen OUT 4 (3164)	116
CANopen outputs		116
	CANopen digital output n°1 (4751)	116
	CANopen digital output n°2 (4752)	116
	CANopen digital output n°3 (4753)	116
	CANopen digital output n°4 (4754)	116
	CANopen digital output n°5 (4755)	116
	CANopen digital output n°6 (4756)	116
	CANopen digital output n°7 (4757)	116
	CANopen digital output n°8 (4758)	117
	CANopen digital output n°9 (4759)	117
	CANopen digital output n°10 (4760)	117
	CANopen digital output n°11 (4761)	117
	CANopen digital output n°12 (4762)	117
	CANopen digital output n°13 (4763)	117
	CANopen digital output n°14 (4764)	117
	CANopen digital output n°15 (4765)	117
	CANopen digital output n°16 (4766)	118
	CANopen digital output n°17 (4767)	118
	CANopen digital output n°18 (4768)	118
	CANopen digital output n°19 (4769)	118
	CANopen digital output n°20 (4770)	118
	CANopen digital output n°21 (4771)	118
	CANopen digital output n°22 (4772)	118
	CANopen digital output n°23 (4773)	118
	CANopen digital output n°24 (4774)	119
	CANopen digital output n°25 (4775)	119
	CANopen digital output n°26 (4776)	119
	CANopen digital output n°27 (4777)	119
	CANopen digital output n°28 (4778)	119
	CANopen digital output n°29 (4779)	119
	CANopen digital output n°30 (4780)	119
	CANopen digital output n°31 (4781)	119
	CANopen digital output n°32 (4782)	120
Timers		120
	Horn Timer (2478)	120
Synchronization		120
	Voltage acceptance (2800)	120
	Frequency acceptance (2801)	120
	Phase Angle acceptance (2802)	120
	Fail to synchronize timer (2803)	120
	Control on fail to synchronize (2804)	120
Logger		121
Activation		121
	Activation (3610)	121
Variables 1-5		121
Log 1		121
	Variable (3600)	121
	Log on (3622)	121

	Period (3612)	121
Log 2	Variable (3601)	121
	Log on (3623)	121
	Period (3613)	122
Log 3	Variable (3602)	122
	Log on (3624)	122
	Period (3614)	122
Log 4	Variable (3603)	122
	Log on (3625)	122
	Period (3615)	122
Log 5	Variable (3604)	123
	Log on (3626)	123
	Period (3616)	123
Variables 6-10		123
Log 6	Variable (3605)	123
	Log on (3627)	123
	Period (3617)	123
Log 7	Variable (3606)	124
	Log on (3628)	124
	Period (3618)	124
Log 8	Variable (3607)	124
	Log on (3629)	124
	Period (3619)	124
Log 9	Variable (3608)	125
	Log on (3630)	125
	Period (3620)	125
Log 10	Variable (3609)	125
	Log on (3631)	125
	Period (3621)	125
Modbus redirection		125
	Modbus 000 (10000)	125

Dynamic

Speed control

Variable	Amplitude (2205)
Unit	V
Min	0.00
Max	10.00
Init	1000
Description	ESG gain (speed output).

Variable	Offset (2206)
Unit	V
Min	-10.00
Max	10.00
Init	0
Description	ESG offset (speed output). When the engine is at nominal speed, the offset need to be parameter to have 50Hz or 60Hz (It depends on your electrical installation).

Variable	Droop (frequency) (2204)
Unit	%
Min	0
Max	20
Init	2
Description	Droop (frequency). The steeper the slope, the more the frequency will drop on an increase in kW A slope that is too shallow, on the other hand, will give an imprecise distribution.

Variable	Speed output inversion (2212)
Unit	-
Min	0
Max	1
Init	0
Description	Speed output inversion. Allow a reversing of wiring (not physical).

Variable	Dead band (3650)
Unit	%
Min	0.00
Max	100.00
Init	100
Description	This setpoint adjusts the "Dead Band" in case of speed control by pulses. This dead band in % determinated the area around nominal frequency with no actions regarding +/- pulses output. If nominal frequency 50Hz, dead band 1 %. No pulse output between 49,5Hz to 50,5Hz

Variable	Frequency pulse divider (3652)
Unit	-
Min	0
Max	100
Init	5
Description	This setpoint adjusts the "pulse divider" in case of speed control by pulses. This pulse divider is able to change the response time of speed control by pulses. If you increase the value of pulse divider, you will decrease the time of pulse active.

AVR control

Variable	AVR Amplitude (2251)
Unit	V
Min	0.00
Max	10.00
Init	1000
Description	This setpoint adjusts the "AVR amplitude". This setpoint is used in case of analog voltage control. This amplitude must be set to obtain a maximum and linear amplitude of 8% (correction until 432Vac for 400Vac application). 10% set on the product is equivalent of a correction of 1Vdc from controller to AVR.

Variable	AVR Offset (2252)
Unit	V
Min	-10.00
Max	10.00
Init	0
Description	This setpoint adjusts the "AVR offset". This setpoint is used in case of analog voltage control. This offset must be set to obtain the nominal voltage at the alternator, in case of no correction. 10% set on the product is equivalent of a correction of 1Vdc from controller to AVR.

Variable	Droop (voltage) (2250)
Unit	%
Min	0
Max	20
Init	2
Description	Droop (voltage). The steeper the slope, the more the voltage will drop on an increase in kVAR. A slope that is too shallow, on the other hand, will give an imprecise distribution.

Variable	AVR signal output inversion (2254)
Unit	-
Min	0
Max	1
Init	0
Description	This setpoint adjusts the "AVR signal output inversion". For most of AVR brand connection : - The module increase the AVR output signal to increase the alternator voltage (Voltage external setpoint). - 0 to +10Vdc : increase the alternator voltage. With the variable : "AVR signal output inversion" activated, the correction will be in opposite action : - 0 to +10Vdc : decrease the alternator voltage.

Variable	Dead Band (3651)
Unit	%
Min	0.00
Max	100.00
Init	100
Description	This setpoint adjusts the "Dead Band" in case of voltage control by pulses. This dead band in % determined the area around nominal voltage, with no actions regarding +/- pulses output. If nominal voltage 400Vac, dead band 1 %. No pulse output between 396Vac to 404Vac

Variable	Voltage pulse divider (3653)
Unit	-
Min	0
Max	100
Init	5
Description	This setpoint adjusts the "pulse divider" in case of voltage control by pulses. This pulse divider is able to change the response time of voltage control by pulses. If you increase the value of pulse divider, you will decrease the time of pulse active.

Synchronization PID

Frequency

Variable	Frequency Global Gain (2900)
Unit	-
Min	0
Max	100
Init	10
Description	The frequency synchronisation is used to match the frequency of our genset to the frequency of the busbar or mains, in order to close its breaker in good condition. This variable sets the global Gain of frequency synchronisation PID. The global Gain is the multiplier of the proportional, integral and derivative values. A too high value will cause a pumping, a too low value will cause a low reaction, We can compare it to a nervousness Gain.

Variable	Frequency Proportional Gain (2901)
Unit	-
Min	0
Max	100
Init	7
Description	Proportional value adjusts the response of the system to a static, instant error, it increases the precision and speed. A too high setting has the effect of generating an oscillation of the system,

Variable	Frequency Integral Gain (2902)
Unit	-
Min	0
Max	100
Init	10
Description	The Integral value set the final value of the system without error. It fixes a small mistake which is prolonged. It increases the final accuracy. A too high setting has the effect of generating an oscillation of the system

Variable	Frequency Derivate Gain (2903)
Unit	-
Min	0
Max	100
Init	0
Description	Derivate value change the increasing time to reach the set point. It increases stability and speed.

Phase

Variable	Phase Global Gain (2904)
Unit	-
Min	0
Max	100
Init	10
Description	The phase synchronisation is used to match the phase of our genset to the phase of the busbar or mains, in order to close its breaker in good condition. This variable sets the global Gain of phase synchronisation PID. The global Gain is the multiplier of the proportional, integral and derivative values. A too high value will cause a pumping, a too low value will cause a low reaction, We can compare it to a nervousness Gain.

Variable	Phase Proportional Gain (2905)
Unit	-
Min	0
Max	100
Init	30
Description	Proportional value to adjust the response of the system to a static, instant error, it increases the precision and speed. A too high setting has the effect of generating an oscillation of the system,

Variable	Phase Integral Gain (2906)
Unit	-
Min	0
Max	100
Init	10
Description	The Integral value set the final value of the system without error. It fixes a small mistake which is prolonged. It increases the final accuracy. A too high setting has the effect of generating an oscillation of the system

Variable	Phase Derivate Gain (2907)
Unit	-
Min	0
Max	100
Init	0
Description	Derivate value change the increasing time to reach the set point. It increases stability and speed.

Voltage

Variable	Voltage Global Gain (2950)
Unit	-
Min	0
Max	100
Init	10
Description	The voltage synchronisation is used to match the voltage of our genset to the voltage of the busbar or mains, in order to close its breaker in good condition. This variable sets the global Gain of voltage synchronisation PID. The global Gain is the multiplier of the proportional, integral and derivative values. A too high value will cause a pumping, a too low value will cause a low reaction, We can compare it to a nervousness Gain.

Variable	Voltage Proportional Gain (2951)
Unit	-
Min	0
Max	100
Init	20
Description	Proportional value to adjust the response of the system to a static, instant error, it increases the precision and speed. A too high setting has the effect of generating an oscillation of the system,

Variable	Voltage Integral Gain (2952)
Unit	-
Min	0
Max	100
Init	15
Description	The Integral value set the final value of the system without error. It fixes a small mistake which is prolonged. It increases the final accuracy. A too high setting has the effect of generating an oscillation of the system

Variable	Voltage Derivate Gain (2953)
Unit	-
Min	0
Max	100
Init	0
Description	Derivate value change the increasing time to reach the set point. It increases stability and speed.

Configuration

General

Variable	My number (2001)
Unit	-
Min	1
Max	32
Init	1
Description	Generator number. This parameter is the ID of the product used for the CAN communication between products. It must be different on each product of the power plant.

Variable	Number of generator (2000)
Unit	-
Min	1
Max	32
Init	1
Description	Number of generator on the power plant. This parameter is used for the CAN communication between products.

Variable	Voltage system (2003)
Unit	-
Min	0
Max	2
Init	2
Description	This setpoint is used to select the alternator voltage architecture. 3 setpoints can be used : - Single phase (value 0) : Connection of 1 active phase wiring and 1 neutral wiring for generator and for Mains. - biphases 180° (value 1) : Connection of 2 active phases wiring and 1 neutral wiring for generator and for Mains. - three phases 180° (value 2) : Connection of 3 active phases wiring and 1 neutral wiring for generator and for Mains. If the neutral wiring is not connected , the product will internally recalculate a virtual one.

Variable	Dead bus management (2002)
Unit	-
Min	0
Max	1
Init	1
Description	Deab bus management (0 : Off, 1 : On). If this parameter is disabled, the product will close the breaker immediately if there is no voltage on the bus bar. If this parameter is enabled, the product will "discuss" with the others products (CAN communcation) to avoid a simultaneously closure of the breakers.

Generator

Variable	Nominal voltage (2102)
Unit	V
Min	0
Max	65 535
Init	400
Description	This setpoint adjusts the nominal voltage U (for phase-phase value). All the electrical protections for U on % will be calculated around this nominal value. For low voltage application (400VAC, 440VAC, 480VAC,etc...) or High Voltage application (20.000 VAC, 33.000VAC, etc ..), this setpoint must be adapted.

Variable	PT ratio (2100)
Unit	-
Min	0.00
Max	655.35
Init	100
Description	This setpoint adjusts the PT ratio to adapt alternator voltage measurement on the module. This setpoint is calculated with Bus Voltage / voltage measurement on the controller. Example : Voltage on bus 20.000Vac / voltage on controller 100 Vac : value of PT ratio = $20.000/100 = 200$. This PT ratio can be calculated or indicated on the step down measurement transformer.

Bus

Variable	Nominal voltage (2152)
Unit	V
Min	0
Max	65 535
Init	400
Description	This setpoint adjusts the bus/mains nominal voltage U (for phase-phase value). All the electrical protections for U on % will be calculated around this nominal value. For low voltage application (400VAC, 440VAC, 480VAC,etc...) or High Voltage application (20.000 VAC, 33.000VAC, etc ..), this setpoint must be adapted.

Variable	PT ratio (2150)
Unit	-
Min	0.00
Max	655.35
Init	100
Description	This setpoint adjusts the PT ratio to adapt voltage measurement on the module. This setpoint is calculated with Voltage / voltage measurement on the controller. Example : Voltage on bus/Mains/source 20.000Vac / voltage on controller 100 Vac : value of PT ratio = $20.000/100 = 200$. This PT ratio can be calculated or indicated on the step down measurement transformer.

Engine

General

Variable	Number of poles pair (2202)
Unit	-
Min	0
Max	20
Init	2
Description	pole pair number of your alternator. It will be used to measure the speed of your engine.

Variable	Speed setpoint (2207)
Unit	RPM
Min	0
Max	10 000
Init	1500
Description	Enter the instruction of speed has to respect. The Engine do not exceed this set point. For an electricity network of 50Hz put 1500 rpm and for a electricity network of 60Hz put 1800 rpm.

J1939

Variable	Manufacturer (3100)
Unit	-
Min	0
Max	32
Init	0
Description	Choose the Manufacturer of you engine. If the manufacturer is not in the list, choose "Generic".

Variable	ECU type (3101)
Unit	-
Min	0
Max	32
Init	0
Description	Choose the model of your ECU. If your ECU is not in the list, choose "Generic".

Inputs

Digital inputs

Variable	Input 1 (Customisable) (250)
Unit	-
Min	0
Max	1
Init	-
Description	Digital input 1

Variable	Input 2 (Customisable) (251)
Unit	-
Min	0
Max	1
Init	-
Description	Digital input 2

Variable	Input 3 (Customisable) (252)
Unit	-
Min	0
Max	1
Init	-
Description	Digital input 3

Variable	Input 4 (Customisable) (253)
Unit	-
Min	0
Max	1
Init	-
Description	Digital input 4

Variable	Input 5 (Customisable) (254)
Unit	-
Min	0
Max	1
Init	-
Description	Digital input 5

Variable	Input 6 (Customisable) (255)
Unit	-
Min	0
Max	1
Init	-
Description	Digital input 6

Variable	Input 7 (Customisable) (256)
Unit	-
Min	0
Max	1
Init	-
Description	Digital input 7

Variable	Input 8 (Customisable) (257)
Unit	-
Min	0
Max	1
Init	-
Description	Digital input 8

Variable	Input 9 (Customisable) (258)
Unit	-
Min	0
Max	1
Init	-
Description	Digital input 9

Hysteresis DI

Hysteresis DI 1

Variable	Hysteresis 1 enable for DI (2769)
Unit	-
Min	0
Max	1
Init	0
Description	Enable hysteresis 1 on digital inputs functions

Variable	Timer (2777)
Unit	s
Min	0.0
Max	999.9
Init	0
Description	Timer at activation on digital input of Hysteresis 1

Variable	Direction (2785)
Unit	-
Min	0
Max	1
Init	0
Description	Direction Hysteresis 1 : 0 = Set on low thresh. - Reset on high thresh. / 1 = Set on high thresh. - Reset on low thresh.

Hysteresis DI 2

Variable	Hysteresis 2 enable for DI (2770)
Unit	-
Min	0
Max	1
Init	0
Description	Enable hysteresis 2 on digital inputs functions

Variable	Timer (2778)
Unit	s
Min	0.0
Max	999.9
Init	0
Description	Timer at activation on digital input of Hysteresis 2

Variable	Direction (2786)
Unit	-
Min	0
Max	1
Init	0
Description	Direction Hysteresis 2 : 0 = Set on low thresh. - Reset on high thresh. / 1 = Set on high thresh. - Reset on low thresh.

Hysteresis DI 3

Variable	Hysteresis 3 enable for DI (2771)
Unit	-
Min	0
Max	1
Init	0
Description	Enable hysteresis 3 on digital inputs functions

Variable	Timer (2779)
Unit	s
Min	0.0
Max	999.9
Init	0
Description	Timer at activation on digital input of Hysteresis 3

Variable	Direction (2787)
Unit	-
Min	0
Max	1
Init	0
Description	Direction Hysteresis 3 : 0 = Set on low thresh. - Reset on high thresh. / 1 = Set on high thresh. - Reset on low thresh.

Hysteresis DI 4

Variable	Hysteresis 4 enable for DI (2772)
Unit	-
Min	0
Max	1
Init	0
Description	Enable hysteresis 4 on digital inputs functions

Variable	Timer (2780)
Unit	s
Min	0.0
Max	999.9
Init	0
Description	Timer at activation on digital input of Hysteresis 4

Variable	Direction (2788)
Unit	-
Min	0
Max	1
Init	0
Description	Direction Hysteresis 4 : 0 = Set on low thresh. - Reset on high thresh. / 1 = Set on high thresh. - Reset on low thresh.

Hysteresis DI 5

Variable	Hysteresis 5 enable for DI (2773)
Unit	-
Min	0
Max	1
Init	0
Description	Enable hysteresis 5 on digital inputs functions

Variable	Timer (2781)
Unit	s
Min	0.0
Max	999.9
Init	0
Description	Timer at activation on digital input of Hysteresis 5

Variable	Direction (2789)
Unit	-
Min	0
Max	1
Init	0
Description	Direction Hysteresis 5 : 0 = Set on low thresh. - Reset on high thresh. / 1 = Set on high thresh. - Reset on low thresh.

Hysteresis DI 6

Variable	Hysteresis 6 enable for DI (2774)
Unit	-
Min	0
Max	1
Init	0
Description	Enable hysteresis 6 on digital inputs functions

Variable	Timer (2782)
Unit	s
Min	0.0
Max	999.9
Init	0
Description	Timer at activation on digital input of Hysteresis 6

Variable	Direction (2790)
Unit	-
Min	0
Max	1
Init	0
Description	Direction Hysteresis 6 : 0 = Set on low thresh. - Reset on high thresh. / 1 = Set on high thresh. - Reset on low thresh.

Hysteresis DI 7

Variable	Hysteresis 7 enable for DI (2775)
Unit	-
Min	0
Max	1
Init	0
Description	Enable hysteresis 7 on digital inputs functions

Variable	Timer (2783)
Unit	s
Min	0.0
Max	999.9
Init	0
Description	Timer at activation on digital input of Hysteresis 7

Variable	Direction (2791)
Unit	-
Min	0
Max	1
Init	0
Description	Direction Hysteresis 7 : 0 = Set on low thresh. - Reset on high thresh. / 1 = Set on high thresh. - Reset on low thresh.

Hysteresis DI 8

Variable	Hysteresis 8 enable for DI (2776)
Unit	-
Min	0
Max	1
Init	0
Description	Enable hysteresis 8 on digital inputs functions

Variable	Timer (2784)
Unit	s
Min	0.0
Max	999.9
Init	0
Description	Timer at activation on digital input of Hysteresis 8

Variable	Direction (2792)
Unit	-
Min	0
Max	1
Init	0
Description	Direction Hysteresis 8 : 0 = Set on low thresh. - Reset on high thresh. / 1 = Set on high thresh. - Reset on low thresh.

Analog inputs

Variable	Analog 1 (Customisable) (150)
Unit	mBar
Min	-3276.7
Max	3276.7
Init	-
Description	Analog 1 measure

Variable	Analog 2 (Customisable) (151)
Unit	°C
Min	-3276.7
Max	3276.7
Init	-
Description	Analog 2 measure

Variable	Analog 3 (Customisable) (152)
Unit	-
Min	-3276.7
Max	3276.7
Init	-
Description	Analog 3 measure

Hysteresis AI

Hysteresis AI 1

Variable	Activating Hysteresis on Analog Input 1 (2657)
Unit	-
Min	0
Max	1
Init	0
Description	Enable hysteresis on analog input 1 with thresholds E2660(Low Level) & E2663(High Level)

Variable	Low level threshold (2660)
Unit	-
Min	0
Max	65 535
Init	0
Description	Low level threshold for digital output activation on hysteresis (analog input 1)

Variable	Timer on low level threshold (2666)
Unit	s
Min	0.0
Max	999.9
Init	30
Description	Timer before set/reset digital output on hysteresis low threshold (analog input 1)

Variable	High level threshold (2663)
Unit	-
Min	0
Max	65 535
Init	0
Description	High level threshold for digital output activation on hysteresis (analog input 1)

Variable	Timer on high level threshold (2669)
Unit	s
Min	0.0
Max	999.9
Init	30
Description	Timer before set/reset digital output on hysteresis high threshold (analog input 1)

Variable	Hysteresis Direction on Analog Input 1 (2672)
Unit	-
Min	0
Max	1
Init	0
Description	Hysteresis Direction on Analog Input 1 (0 : Set on low thresh. - Reset on high thresh. / 1 : Set on high thresh. - Reset on low thresh)

Hysteresis AI 2

Variable	Activating Hysteresis on Analog Input 2 (2658)
Unit	-
Min	0
Max	1
Init	0
Description	Enable hysteresis on analog input 2 with thresholds E2661(Low Level) & E2664(High Level)

Variable	Low level threshold (2661)
Unit	-
Min	0
Max	65 535
Init	0
Description	Low level threshold for digital output activation on hysteresis (analog input 2)

Variable	Timer on low level threshold (2667)
Unit	s
Min	0.0
Max	999.9
Init	30
Description	Timer before set/reset digital output on hysteresis low threshold (analog input 2)

Variable	High level threshold (2664)
Unit	-
Min	0
Max	65 535
Init	0
Description	High level threshold for digital output activation on hysteresis (analog input 2)

Variable	Timer on high level threshold (2670)
Unit	s
Min	0.0
Max	999.9
Init	30
Description	Timer before set/reset digital output on hysteresis high threshold (analog input 2)

Variable	Hysteresis Direction on Analog Input 2 (2673)
Unit	-
Min	0
Max	1
Init	0
Description	Hysteresis Direction on Analog Input 2 (0 : Set on low thresh. - Reset on high thresh. / 1 : Set on high thresh. - Reset on low thresh)

Hysteresis AI 3

Variable	Activating Hysteresis on Analog Input 3 (2659)
Unit	-
Min	0
Max	1
Init	0
Description	Enable hysteresis on analog input 3 with thresholds E2662(Low Level) & E2665(High Level)

Variable	Low level threshold (2662)
Unit	-
Min	0
Max	65 535
Init	0
Description	Low level threshold for digital output activation on hysteresis (analog input 3)

Variable	Timer on low level threshold (2668)
Unit	s
Min	0.0
Max	999.9
Init	30
Description	Timer before set/reset digital output on hysteresis low threshold (analog input 3)

Variable	High level threshold (2665)
Unit	-
Min	0
Max	65 535
Init	0
Description	High level threshold for digital output activation on hysteresis (analog input 3)

Variable	Timer on high level threshold (2671)
Unit	s
Min	0.0
Max	999.9
Init	30
Description	Timer before set/reset digital output on hysteresis high threshold (analog input 3)

Variable	Hysteresis Direction on Analog Input 3 (2674)
Unit	-
Min	0
Max	1
Init	0
Description	Hysteresis Direction on Analog Input 3 (0 : Set on low thresh. - Reset on high thresh. / 1 : Set on high thresh. - Reset on low thresh)

Outputs

Digital outputs

Variable	Status Digital Output 1 (4350)
Unit	-
Min	0
Max	1
Init	-
Description	Real time displayed status of Digital Output 1

Variable	Status Digital Output 2 (4351)
Unit	-
Min	0
Max	1
Init	-
Description	Real time displayed status of Digital Output 2

Variable	Status Digital Output 3 (4352)
Unit	-
Min	0
Max	1
Init	-
Description	Real time displayed status of Digital Output 3

Variable	Status Digital Output 4 (4353)
Unit	-
Min	0
Max	1
Init	-
Description	Real time displayed status of Digital Output 4

Variable	Status Digital Output 5 (4354)
Unit	-
Min	0
Max	1
Init	-
Description	Real time displayed status of Digital Output 5

Variable	Status Digital Output 6 (4355)
Unit	-
Min	0
Max	1
Init	-
Description	Real time displayed status of Digital Output 6

Relay outputs

Variable	Status Relay Output 1 (4356)
Unit	-
Min	0
Max	1
Init	-
Description	Real time displayed status of Relay Output 1

Variable	Status Relay Output 2 (4357)
Unit	-
Min	0
Max	1
Init	-
Description	Real time displayed status of Relay Output 2

Generator protections

Over/under frequency

Over frequency

Variable	Over frequency threshold (2400)
Unit	%
Min	0.0
Max	200.0
Init	1050
Description	Over-frequency Generator Protection Threshold

Variable	Over frequency timer (2401)
Unit	s
Min	0.0
Max	999.9
Init	300
Description	Timer acceptance before protection activation when Generator Frequency has reached the over-frequency protection threshold

Variable	Over frequency control (2402)
Unit	-
Min	0
Max	7
Init	1
Description	Control selection when Generator Over-frequency protection become active.The selections are the following : - Unused : no action. - Generator electrical fault : The protection opens the generator breaker and tries to re-synchronize again. Count of attempts set by variable 2807. - Mains electrical fault : The protection opens the Mains breaker. - Alarm : Notice as alarm on front panel. - Fault (soft shutdown) : Generator breaker opens allowing the engine to cool down off load for the duration of the cool down timer, then stop. - Security (hard shutdown) : Generator breaker opens and engine stops immediately without cooling down : "serious fault" shows as information. - +Help means the faulty generator will ask another genset to start through inter-module Buscan to replace it.

Under frequency

Variable	Under frequency threshold (2403)
Unit	%
Min	0.0
Max	200.0
Init	900
Description	Under-frequency Generator Protection Threshold

Variable	Under frequency timer (2404)
Unit	s
Min	0.0
Max	999.9
Init	100
Description	Timer acceptance before protection activation when Generator Frequency has reached the Under-frequency protection threshold

Variable	Under frequency control (2405)
Unit	-
Min	0
Max	7
Init	1
Description	Control selection when Generator Under-frequency protection become active.The selections are the following : - Unused : no action. - Generator electrical fault : The protection opens the generator breaker and tries to re-synchronize again. Count of attempts set by variable 2807. - Mains electrical fault : The protection opens the Mains breaker. - Alarm : Notice as alarm on front panel. - Fault (soft shutdown) : Generator breaker opens allowing the engine to cool down off load for the duration of the cool down timer, then stop. - Security (hard shutdown) : Generator breaker opens and engine stops immediately without cooling down : "serious fault" shows as information. - +Help means the faulty generator will ask another genset to start through inter-module Buscan to replace it.

Over frequency 2

Variable	Over frequency threshold 2 (2436)
Unit	%
Min	0.0
Max	200.0
Init	1100
Description	Over-frequency Generator Protection Threshold 2

Variable	Over frequency timer 2 (2437)
Unit	s
Min	0.0
Max	999.9
Init	100
Description	Timer 2 acceptance before protection activation when Generator Frequency has reached the over-frequency protection threshold

Variable	Over frequency control 2 (2438)
Unit	-
Min	0
Max	7
Init	0
Description	Control 2 selection when Generator Over-frequency protection become active. The selections are the following : - Unused : no action. - Generator electrical fault : The protection opens the generator breaker and tries to re-synchronize again. Count of attempts set by variable 2807. - Mains electrical fault : The protection opens the Mains breaker. - Alarm : Notice as alarm on front panel. - Fault (soft shutdown) : Generator breaker opens allowing the engine to cool down off load for the duration of the cool down timer, then stop. - Security (hard shutdown) : Generator breaker opens and engine stops immediately without cooling down : "serious fault" shows as information. - +Help means the faulty generator will ask another genset to start through inter-module Buscan to replace it.

Under frequency 2

Variable	Under frequency threshold 2 (2439)
Unit	%
Min	0.0
Max	200.0
Init	900
Description	Under-frequency Generator Protection Threshold 2

Variable	Under frequency timer 2 (2440)
Unit	s
Min	0.0
Max	999.9
Init	100
Description	Timer 2 acceptance before protection activation when Generator Frequency has reached the Under-frequency protection threshold

Variable	Under frequency control 2 (2441)
Unit	-
Min	0
Max	7
Init	0
Description	Control 2 selection when Generator Under-frequency protection become active. The selections are the following : - Unused : no action. - Generator electrical fault : The protection opens the generator breaker and tries to re-synchronize again. Count of attempts set by variable 2807. - Mains electrical fault : The protection opens the Mains breaker. - Alarm : Notice as alarm on front panel. - Fault (soft shutdown) : Generator breaker opens allowing the engine to cool down off load for the duration of the cool down timer, then stop. - Security (hard shutdown) : Generator breaker opens and engine stops immediately without cooling down : "serious fault" shows as information. - +Help means the faulty generator will ask another genset to start through inter-module Buscan to replace it.

Over/under voltage

Over voltage

Variable	Over voltage threshold (2406)
Unit	%
Min	0.0
Max	200.0
Init	1100
Description	Over-voltage Generator Protection Threshold

Variable	Over voltage timer (2407)
Unit	s
Min	0.0
Max	999.9
Init	100
Description	Timer acceptance before protection activation when Generator voltage has reached the over-voltage protection threshold

Variable	Over voltage control (2408)
Unit	-
Min	0
Max	7
Init	1
Description	Control selection when Generator Over-voltage protection become active. The selections are the following : - Unused : no action. - Generator electrical fault : The protection opens the generator breaker and tries to re-synchronize again. Count of attempts set by variable 2807. - Mains electrical fault : The protection opens the Mains breaker. - Alarm : Notice as alarm on front panel. - Fault (soft shutdown) : Generator breaker opens allowing the engine to cool down off load for the duration of the cool down timer, then stop. - Security (hard shutdown) : Generator breaker opens and engine stops immediately without cooling down : "serious fault" shows as information. - +Help means the faulty generator will ask another genset to start through inter-module Buscan to replace it.

Under voltage

Variable	Under voltage threshold (2409)
Unit	%
Min	0.0
Max	200.0
Init	900
Description	Under-voltage Generator Protection Threshold

Variable	Under voltage timer (2410)
Unit	s
Min	0.0
Max	999.9
Init	200
Description	Timer acceptance before protection activation when Generator voltage has reached the Under-voltage protection threshold

Variable	Under voltage control (2411)
Unit	-
Min	0
Max	7
Init	1
Description	Control selection when Generator Under-voltage protection become active. The selections are the following : - Unused : no action. - Generator electrical fault : The protection opens the generator breaker and tries to re-synchronize again. Count of attempts set by variable 2807. - Mains electrical fault : The protection opens the Mains breaker. - Alarm : Notice as alarm on front panel. - Fault (soft shutdown) : Generator breaker opens allowing the engine to cool down off load for the duration of the cool down timer, then stop. - Security (hard shutdown) : Generator breaker opens and engine stops immediately without cooling down : "serious fault" shows as information. - +Help means the faulty generator will ask another genset to start through inter-module Buscan to replace it.

Over voltage 2

Variable	Over voltage threshold 2 (2442)
Unit	%
Min	0.0
Max	200.0
Init	1100
Description	Over-voltage Generator Protection Threshold 2

Variable	Over voltage timer 2 (2443)
Unit	s
Min	0.0
Max	999.9
Init	100
Description	Timer 2 acceptance before protection activation when Generator voltage has reached the over-voltage protection threshold

Variable	Over voltage control 2 (2444)
Unit	-
Min	0
Max	7
Init	0
Description	Control 2 selection when Generator Over-voltage protection become active.The selections are the following : - Unused : no action. - Generator electrical fault : The protection opens the generator breaker and tries to re-synchronize again. Count of attempts set by variable 2807. - Mains electrical fault : The protection opens the Mains breaker. - Alarm : Notice as alarm on front panel. - Fault (soft shutdown) : Generator breaker opens allowing the engine to cool down off load for the duration of the cool down timer, then stop. - Security (hard shutdown) : Generator breaker opens and engine stops immediately without cooling down : "serious fault" shows as information. - +Help means the faulty generator will ask another genset to start through inter-module Buscan to replace it.

Under voltage 2

Variable	Under voltage threshold 2 (2445)
Unit	%
Min	0.0
Max	200.0
Init	900
Description	Under-voltage Generator Protection Threshold 2

Variable	Under voltage timer 2 (2446)
Unit	s
Min	0.0
Max	999.9
Init	200
Description	Timer 2 acceptance before protection activation when Generator voltage has reached the Under-voltage protection threshold

Variable	Under voltage control 2 (2447)
Unit	-
Min	0
Max	7
Init	0
Description	Control 2 selection when Generator Under-voltage protection become active.The selections are the following : - Unused : no action. - Generator electrical fault : The protection opens the generator breaker and tries to re-synchronize again. Count of attempts set by variable 2807. - Mains electrical fault : The protection opens the Mains breaker. - Alarm : Notice as alarm on front panel. - Fault (soft shutdown) : Generator breaker opens allowing the engine to cool down off load for the duration of the cool down timer, then stop. - Security (hard shutdown) : Generator breaker opens and engine stops immediately without cooling down : "serious fault" shows as information. - +Help means the faulty generator will ask another genset to start through inter-module Buscan to replace it.

Voltage unbalance

Voltage unbalance

Variable	Voltage unbalance threshold (2486)
Unit	%
Min	0.0
Max	200.0
Init	50
Description	Voltage Unbalance Generator Protection Threshold

Variable	Voltage unbalance timer (2487)
Unit	s
Min	0.0
Max	999.9
Init	30
Description	Timer acceptance before protection activation when Generator voltage has reached the Voltage Unbalance protection threshold

Variable	Voltage unbalance control (2488)
Unit	-
Min	0
Max	7
Init	0
Description	Control selection when Generator Voltage Unbalance protection become active. The selections are the following : <ul style="list-style-type: none">- Unused : no action.- Generator electrical fault : The protection opens the generator breaker and tries to re-synchronize again. Count of attempts set by variable 2807.- Mains electrical fault : The protection opens the Mains breaker.- Alarm : Notice as alarm on front panel.- Fault (soft shutdown) : Generator breaker opens allowing the engine to cool down off load for the duration of the cool down timer, then stop.- Security (hard shutdown) : Generator breaker opens and engine stops immediately without cooling down : "serious fault" shows as information.- +Help means the faulty generator will ask another genset to start through inter-module Buscan to replace it.

Voltage unbalance 2

Variable	Voltage unbalance threshold 2 (2489)
Unit	%
Min	0.0
Max	200.0
Init	100
Description	Voltage Unbalance Generator Protection Threshold 2

Variable	Voltage unbalance timer 2 (2490)
Unit	s
Min	0.0
Max	999.9
Init	30
Description	Timer 2 acceptance before protection activation when Generator voltage has reached the Voltage Unbalance protection threshold

Variable	Voltage unbalance control 2 (2491)
Unit	-
Min	0
Max	7
Init	0
Description	Control 2 selection when Generator Voltage Unbalance protection become active. The selections are the following : - Unused : no action. - Generator electrical fault : The protection opens the generator breaker and tries to re-synchronize again. Count of attempts set by variable 2807. - Mains electrical fault : The protection opens the Mains breaker. - Alarm : Notice as alarm on front panel. - Fault (soft shutdown) : Generator breaker opens allowing the engine to cool down off load for the duration of the cool down timer, then stop. - Security (hard shutdown) : Generator breaker opens and engine stops immediately without cooling down : "serious fault" shows as information. - +Help means the faulty generator will ask another genset to start through inter-module Buscan to replace it.

Other protections

Analog inputs

Analog input 1

Variable	AN1 min/max (Customisable) (4206)
Unit	-
Min	0
Max	3
Init	-
Description	This value is to customize the label of analog input 1 protection. The maximum number of characters is of 14. This protection use the analog input 1 set in the "Analog inputs" chapter (variable 150).

Variable	Analog input 1 threshold (2600)
Unit	-
Min	-32767
Max	32767
Init	0
Description	This setpoint adjusts the threshold level for analog input 1 protection. The setting of this setpoint is according to the unit selected for the analog input 1 (variable 150).

Variable	Analog input 1 timer (2601)
Unit	s
Min	0.0
Max	999.9
Init	0
Description	This setpoint adjusts the delay of the threshold level for analog input 1 detection. This setpoint can be set from 0s to 999,9s. If the threshold's analog input 1 is still detected at the end of the delay, then the action of the parameter "Validation" (variable 2602) will be activated. If the threshold's analog input 1 is no more detected during the delay, then the delay will be reset.

Variable	Analog input 1 control (2602)
Unit	-
Min	0
Max	7
Init	0
Description	<p>This setpoint define the action which will be activated if the threshold level for analog input 1 is detected until the end of the set delay.</p> <p>Possible actions are :</p> <ul style="list-style-type: none"> - Unused : no action. - Generator electrical fault : The protection opens the generator breaker and tries to re-synchronize again. Count of attempts set by variable 2807. - Mains electrical fault : The protection opens the Mains breaker. - Alarm : Notice as alarm on front panel. - Fault (soft shutdown) : Generator breaker opens allowing the engine to cool down off load for the duration of the cool down timer, then stop. - Security (hard shutdown) : Generator breaker opens and engine stops immediately without cooling down : "serious fault" shows as information. <p>-+Help means the faulty generator will ask another genset to start through inter-module Buscan to replace it</p>

Variable	Analog input 1 threshold 2 (2603)
Unit	-
Min	-32767
Max	32767
Init	0
Description	<p>This setpoint adjusts the second threshold level for analog input 1 protection.</p> <p>The setting of this setpoint is according to the unit selected for the analog input 1 (variable 150).</p>

Variable	Analog input 1 timer 2 (2604)
Unit	s
Min	0.0
Max	999.9
Init	0
Description	<p>This setpoint adjusts the delay of the second threshold level for analog input 1 detection.</p> <p>This setpoint can be set from 0s to 999,9s.</p> <p>If the second threshold's analog input 1 is still detected at the end of the delay, then the action of the parameter "Validation" (variable 2605) will be activated.</p> <p>If the second threshold's analog input 1 is no more detected during the delay, then the delay will be reset.</p>

Variable	Analog input 1 control 2 (2605)
Unit	-
Min	0
Max	7
Init	0
Description	<p>This setpoint define the action which will be activated if the second threshold level for analog input 1 is detected until the end of the set delay.</p> <p>Possible actions are :</p> <ul style="list-style-type: none"> - Unused : no action. - Generator electrical fault : The protection opens the generator breaker and tries to re-synchronize again. Count of attempts set by variable 2807. - Mains electrical fault : The protection opens the Mains breaker. - Alarm : Notice as alarm on front panel. - Fault (soft shutdown) : Generator breaker opens allowing the engine to cool down off load for the duration of the cool down timer, then stop. - Security (hard shutdown) : Generator breaker opens and engine stops immediately without cooling down : "serious fault" shows as information. <p>-+Help means the faulty generator will ask another genset to start through inter-module Buscan to replace it</p>

Variable	Direction analog input 1 protection (2606)
Unit	-
Min	0
Max	1
Init	0
Description	This setpoint define if the both threshold level for analog input 1 are minimum or maximum limit. If the setpoint is on "Minimum" then the action of variables 2602 and 2605 will activate from thresholds level set and below. If the setpoint is on "Maximum" then the action of variables 2602 and 2605 will activate from thresholds level set and above.

Analog input 2

Variable	AN2 min/max (Customisable) (4207)
Unit	-
Min	0
Max	3
Init	-
Description	This value is to customize the label of analog input 2 protection. The maximum number of characters is of 14. This protection use the analog input 2 set in the "Analog inputs" chapter (variable 151).

Variable	Analog input 2 threshold (2608)
Unit	-
Min	-32767
Max	32767
Init	0
Description	This setpoint adjusts the threshold level for analog input 2 protection. The setting of this setpoint is according to the unit selected for the analog input 2 (variable 151).

Variable	Analog input 2 timer (2609)
Unit	s
Min	0.0
Max	999.9
Init	0
Description	This setpoint adjusts the delay of the threshold level for analog input 2 detection. This setpoint can be set from 0s to 999,9s. If the threshold's analog input 2 is still detected at the end of the delay, then the action of the parameter "Validation" (variable 2610) will be activated. If the threshold's analog input 2 is no more detected during the delay, then the delay will be reset.

Variable	Analog input 2 control (2610)
Unit	-
Min	0
Max	7
Init	0
Description	<p>This setpoint define the action which will be activated if the threshold level for analog input 2 is detected until the end of the set delay.</p> <p>Possible actions are :</p> <ul style="list-style-type: none"> - Unused : no action. - Generator electrical fault : The protection opens the generator breaker and tries to re-synchronize again. Count of attempts set by variable 2807. - Mains electrical fault : The protection opens the Mains breaker. - Alarm : Notice as alarm on front panel. - Fault (soft shutdown) : Generator breaker opens allowing the engine to cool down off load for the duration of the cool down timer, then stop. - Security (hard shutdown) : Generator breaker opens and engine stops immediately without cooling down : "serious fault" shows as information. <p>-+Help means the faulty generator will ask another genset to start through inter-module Buscan to replace it</p>

Variable	Analog input 2 threshold 2 (2611)
Unit	-
Min	-32767
Max	32767
Init	0
Description	<p>This setpoint adjusts the second threshold level for analog input 2 protection.</p> <p>The setting of this setpoint is according to the unit selected for the analog input 2 (variable 151).</p>

Variable	Analog input 2 timer 2 (2612)
Unit	s
Min	0.0
Max	999.9
Init	0
Description	<p>This setpoint adjusts the delay of the second threshold level for analog input 2 detection.</p> <p>This setpoint can be set from 0s to 999,9s.</p> <p>If the second threshold's analog input 2 is still detected at the end of the delay, then the action of the parameter "Validation" (variable 2613) will be activated.</p> <p>If the second threshold's analog input 2 is no more detected during the delay, then the delay will be reset.</p>

Variable	Analog input 2 control 2 (2613)
Unit	-
Min	0
Max	7
Init	0
Description	<p>This setpoint define the action which will be activated if the second threshold level for analog input 2 is detected until the end of the set delay.</p> <p>Possible actions are :</p> <ul style="list-style-type: none"> - Unused : no action. - Generator electrical fault : The protection opens the generator breaker and tries to re-synchronize again. Count of attempts set by variable 2807. - Mains electrical fault : The protection opens the Mains breaker. - Alarm : Notice as alarm on front panel. - Fault (soft shutdown) : Generator breaker opens allowing the engine to cool down off load for the duration of the cool down timer, then stop. - Security (hard shutdown) : Generator breaker opens and engine stops immediately without cooling down : "serious fault" shows as information. <p>-+Help means the faulty generator will ask another genset to start through inter-module Buscan to replace it</p>

Variable	Direction analog input 2 protection (2614)
Unit	-
Min	0
Max	1
Init	0
Description	This setpoint define if the both threshold level for analog input 2 are minimum or maximum limit. If the setpoint is on "Minimum" then the action of variables 2610 and 2613 will activate from thresholds level set and below. If the setpoint is on "Maximum" then the action of variables 2610 and 2613 will activate from thresholds level set and above.

Analog input 3

Variable	AN3 min/max (Customisable) (4208)
Unit	-
Min	0
Max	3
Init	-
Description	This value is to customize the label of analog input 3 protection. The maximum number of characters is of 14. This protection use the analog input 3 set in the "Analog inputs" chapter (variable 152).

Variable	Analog input 3 threshold (2616)
Unit	-
Min	-32767
Max	32767
Init	0
Description	This setpoint adjusts the threshold level for analog input 3 protection. The setting of this setpoint is according to the unit selected for the analog input 3 (variable 152).

Variable	Analog input 3 timer (2617)
Unit	s
Min	0.0
Max	999.9
Init	0
Description	This setpoint adjusts the delay of the threshold level for analog input 3 detection. This setpoint can be set from 0s to 999,9s. If the threshold's analog input 3 is still detected at the end of the delay, then the action of the parameter "Validation" (variable 2618) will be activated. If the threshold's analog input 3 is no more detected during the delay, then the delay will be reset.

Variable	Analog input 3 control (2618)
Unit	-
Min	0
Max	7
Init	0
Description	<p>This setpoint define the action which will be activated if the threshold level for analog input 3 is detected until the end of the set delay.</p> <p>Possible actions are :</p> <ul style="list-style-type: none"> - Unused : no action. - Generator electrical fault : The protection opens the generator breaker and tries to re-synchronize again. Count of attempts set by variable 2807. - Mains electrical fault : The protection opens the Mains breaker. - Alarm : Notice as alarm on front panel. - Fault (soft shutdown) : Generator breaker opens allowing the engine to cool down off load for the duration of the cool down timer, then stop. - Security (hard shutdown) : Generator breaker opens and engine stops immediately without cooling down : "serious fault" shows as information. <p>-+Help means the faulty generator will ask another genset to start through inter-module Buscan to replace it</p>

Variable	Analog input 3 threshold 2 (2619)
Unit	-
Min	-32767
Max	32767
Init	0
Description	<p>This setpoint adjusts the second threshold level for analog input 3 protection.</p> <p>The setting of this setpoint is according to the unit selected for the analog input 3 (variable 152).</p>

Variable	Analog input 3 timer 2 (2620)
Unit	s
Min	0.0
Max	999.9
Init	0
Description	<p>This setpoint adjusts the delay of the second threshold level for analog input 3 detection.</p> <p>This setpoint can be set from 0s to 999,9s.</p> <p>If the second threshold's analog input 3 is still detected at the end of the delay, then the action of the parameter "Validation" (variable 2621) will be activated.</p> <p>If the second threshold's analog input 3 is no more detected during the delay, then the delay will be reset.</p>

Variable	Analog input 3 control 2 (2621)
Unit	-
Min	0
Max	7
Init	0
Description	<p>This setpoint define the action which will be activated if the second threshold level for analog input 3 is detected until the end of the set delay.</p> <p>Possible actions are :</p> <ul style="list-style-type: none"> - Unused : no action. - Generator electrical fault : The protection opens the generator breaker and tries to re-synchronize again. Count of attempts set by variable 2807. - Mains electrical fault : The protection opens the Mains breaker. - Alarm : Notice as alarm on front panel. - Fault (soft shutdown) : Generator breaker opens allowing the engine to cool down off load for the duration of the cool down timer, then stop. - Security (hard shutdown) : Generator breaker opens and engine stops immediately without cooling down : "serious fault" shows as information. <p>-+Help means the faulty generator will ask another genset to start through inter-module Buscan to replace it</p>

Variable	Direction analog input 1 protection (2622)
Unit	-
Min	0
Max	1
Init	0
Description	This setpoint define if the both threshold level for analog input 3 are minimum or maximum limit. If the setpoint is on "Minimum" then the action of variables 2618 and 2621 will activate from thresholds level set and below. If the setpoint is on "Maximum" then the action of variables 2618 and 2621 will activate from thresholds level set and above.

Battery

Maximum battery voltage

Variable	Max. voltage battery threshold (2359)
Unit	V
Min	0.0
Max	35.0
Init	300
Description	This setpoint adjusts the warning level for battery overvoltage protection. This protection is mainly electrical protection. This setpoint can be set from 0V to 35V.

Variable	Max. voltage battery timer (2360)
Unit	s
Min	0.0
Max	999.9
Init	100
Description	This setpoint adjusts the delay of the battery overvoltage detection. This setpoint can be set from 0s to 999,9s. If the overvoltage is still detected at the end of the delay, then the action of the parameter "Validation" (variable 2361) will be activated. If the overvoltage is no more detected during the delay, then the delay will be reset.

Variable	Max. voltage battery control (2361)
Unit	-
Min	0
Max	7
Init	0
Description	This setpoint define the action which will be activated if a battery overvoltage is detected until the end of the set delay. Possible actions are : - Unused : no action. - Generator electrical fault : The protection opens the generator breaker and tries to re-synchronize again. Count of attempts set by variable 2807. - Mains electrical fault : The protection opens the Mains breaker. - Alarm : Notice as alarm on front panel. - Fault (soft shutdown) : Generator breaker opens allowing the engine to cool down off load for the duration of the cool down timer, then stop. - Security (hard shutdown) : Generator breaker opens and engine stops immediately without cooling down : "serious fault" shows as information.

Minimum battery voltage

Variable	Min. voltage battery threshold (2356)
Unit	V
Min	0.0
Max	35.0
Init	180
Description	This setpoint adjusts the warning level for battery undervoltage protection. This protection is mainly electrical protection. This setpoint can be set from 0V to 35V.

Variable	Min. voltage battery timer (2357)
Unit	s
Min	0.0
Max	999.9
Init	600
Description	This setpoint adjusts the delay of the battery undervoltage detection. This setpoint can be set from 0s to 999,9s. If the undervoltage is still detected at the end of the delay, then the action of the parameter "Validation" (variable 2358) will be activated. If the undervoltage is no more detected during the delay, then the delay will be reset.

Variable	Min. voltage battery control (2358)
Unit	-
Min	0
Max	7
Init	0
Description	This setpoint define the action which will be activated if a battery undervoltage is detected until the end of the set delay. Possible actions are : - Unused : no action. - Generator electrical fault : The protection opens the generator breaker and tries to re-synchronize again. Count of attempts set by variable 2807. - Mains electrical fault : The protection opens the Mains breaker. - Alarm : Notice as alarm on front panel. - Fault (soft shutdown) : Generator breaker opens allowing the engine to cool down off load for the duration of the cool down timer, then stop. - Security (hard shutdown) : Generator breaker opens and engine stops immediately without cooling down : "serious fault" shows as information.

Maximum battery voltage 2

Variable	Max. voltage battery threshold 2 (2377)
Unit	V
Min	0.0
Max	35.0
Init	320
Description	This setpoint adjusts the warning level for battery 2 overvoltage protection. This protection is mainly electrical protection. This setpoint can be set from 0V to 35V.

Variable	Max. voltage battery timer 2 (2378)
Unit	s
Min	0.0
Max	999.9
Init	50
Description	This setpoint adjusts the delay of the battery 2 overvoltage detection. This setpoint can be set from 0s to 999,9s. If the overvoltage is still detected at the end of the delay, then the action of the parameter "Validation" (variable 2361) will be activated. If the overvoltage is no more detected during the delay, then the delay will be reset.

Variable	Max. voltage battery control 2 (2379)
Unit	-
Min	0
Max	7
Init	0
Description	This setpoint define the action which will be activated if a battery 2 overvoltage is detected until the end of the set delay. Possible actions are : - Unused : no action. - Generator electrical fault : The protection opens the generator breaker and tries to re-synchronize again. Count of attempts set by variable 2807. - Mains electrical fault : The protection opens the Mains breaker. - Alarm : Notice as alarm on front panel. - Fault (soft shutdown) : Generator breaker opens allowing the engine to cool down off load for the duration of the cool down timer, then stop. - Security (hard shutdown) : Generator breaker opens and engine stops immediately without cooling down : "serious fault" shows as information. -+Help means the faulty generator will ask another genset to start through inter-module Buscan to replace it

Minimum battery voltage 2

Variable	Min. voltage battery threshold 2 (2374)
Unit	V
Min	0.0
Max	35.0
Init	150
Description	This setpoint adjusts the warning level for battery 2 undervoltage protection. This protection is mainly electrical protection. This setpoint can be set from 0V to 35V.

Variable	Min. voltage battery timer 2 (2375)
Unit	s
Min	0.0
Max	999.9
Init	100
Description	This setpoint adjusts the delay of the battery 2 undervoltage detection. This setpoint can be set from 0s to 999,9s. If the undervoltage is still detected at the end of the delay, then the action of the parameter "Validation" (variable 2358) will be activated. If the undervoltage is no more detected during the delay, then the delay will be reset.

Variable	Min. voltage battery control 2 (2376)
Unit	-
Min	0
Max	7
Init	0
Description	<p>This setpoint define the action which will be activated if a battery 2 undervoltage is detected until the end of the set delay.</p> <p>Possible actions are :</p> <ul style="list-style-type: none"> - Unused : no action. - Generator electrical fault : The protection opens the generator breaker and tries to re-synchronize again. Count of attempts set by variable 2807. - Mains electrical fault : The protection opens the Mains breaker. - Alarm : Notice as alarm on front panel. - Fault (soft shutdown) : Generator breaker opens allowing the engine to cool down off load for the duration of the cool down timer, then stop. - Security (hard shutdown) : Generator breaker opens and engine stops immediately without cooling down : "serious fault" shows as information. <p>-+Help means the faulty generator will ask another genset to start through inter-module Buscan to replace it</p>

Boost battery

Variable	Control boost battery (2388)
Unit	-
Min	0
Max	1
Init	0
Description	<p>This setpoint activate the boost battery function.</p> <p>This function activate the boost battery output with a low threshold (variable 2386) of the battery voltage and deactivate the output with high threshold (variable 2387).</p>

Variable	Low threshold boost battery (2386)
Unit	V
Min	0.0
Max	35.0
Init	200
Description	<p>This setpoint adjusts the low threshold level to activate the boost battery output.</p> <p>This setpoint can be set only if the variable 2388 is activated.</p> <p>This setpoint can be set from 0V to 35V.</p>

Variable	High threshold boost battery (2387)
Unit	V
Min	0.0
Max	35.0
Init	280
Description	<p>This setpoint adjusts the high threshold level to deactivate the boost battery output.</p> <p>This setpoint can be set only if the variable 2388 is activated.</p> <p>This setpoint can be set from 0V to 35V.</p> <p>This threshold have to be higher than the low threshold (variable 2386).</p>

Outputs

Max/Min speed output

Variable	Timer Min Max Speed output (2389)
Unit	s
Min	0.0
Max	999.9
Init	100
Description	Timer acceptance before alarm for speed output signal to speed governor to stay at Minimum or Maximum signal correction

Variable	Control Min Max Speed output (2390)
Unit	-
Min	0
Max	7
Init	0
Description	Control selection when speed output signal protection become active. The selections are the following : - Unused : no action. - Generator electrical fault : The protection opens the generator breaker and tries to re-synchronize again. Count of attempts set by variable 2807. - Mains electrical fault : The protection opens the Mains breaker. - Alarm : Notice as alarm on front panel. - Fault (soft shutdown) : Generator breaker opens allowing the engine to cool down off load for the duration of the cool down timer, then stop. - Security (hard shutdown) : Generator breaker opens and engine stops immediately without cooling down : "serious fault" shows as information. - +Help means the faulty generator will ask another genset to start through inter-module Buscan to replace it.

Max/Min AVR output

Variable	Timer Min Max AVR output (2391)
Unit	s
Min	0.0
Max	999.9
Init	100
Description	Timer acceptance before alarm for voltage output signal to AVR/DVR regulator to stay at Minimum or Maximum signal correction

Variable	Control Min Max AVR output (2392)
Unit	-
Min	0
Max	7
Init	0
Description	Control selection when AVR output signal protection become active. The selections are the following : - Unused : no action. - Generator electrical fault : The protection opens the generator breaker and tries to re-synchronize again. Count of attempts set by variable 2807. - Mains electrical fault : The protection opens the Mains breaker. - Alarm : Notice as alarm on front panel. - Fault (soft shutdown) : Generator breaker opens allowing the engine to cool down off load for the duration of the cool down timer, then stop. - Security (hard shutdown) : Generator breaker opens and engine stops immediately without cooling down : "serious fault" shows as information. - +Help means the faulty generator will ask another genset to start through inter-module Buscan to replace it.

CANopen

CANopen

CANopen

Variable	CAN2 baud rate (3051)
Unit	-
Min	0
Max	65 535
Init	125
Description	CAN bus 2 baud speed (J1939/CANopen)

Variable	Error timer (3152)
Unit	s
Min	0.0
Max	6553.5
Init	100
Description	CANopen error timer

Coupler 1

Variable	Coupler ID # 1 (3153)
Unit	-
Min	0
Max	255
Init	0
Description	Coupler identifier, In client Config mode, we can add several couplers and for each coupler a unique identifier is dedicated by the client

Variable	CANopen IN 1 (3154)
Unit	-
Min	0
Max	32
Init	0
Description	Each coupler is associated with an input number

Variable	CANopen OUT 1 (3155)
Unit	-
Min	0
Max	32
Init	0
Description	Each coupler is associated with output number

Coupler 2

Variable	Coupler ID # 2 (3156)
Unit	-
Min	0
Max	255
Init	0
Description	Coupler identifier, In client Config mode, we can add several couplers and for each coupler a unique identifier is dedicated by the client

Variable	CANopen IN 2 (3157)
Unit	-
Min	0
Max	32
Init	0
Description	Each coupler is associated with an input number

Variable	CANopen OUT 2 (3158)
Unit	-
Min	0
Max	32
Init	0
Description	Each coupler is associated with output number

Coupler 3

Variable	Coupler ID # 3 (3159)
Unit	-
Min	0
Max	255
Init	0
Description	Coupler identifier, In client Config mode, we can add several couplers and for each coupler a unique identifier is dedicated by the client

Variable	CANopen IN 3 (3160)
Unit	-
Min	0
Max	32
Init	0
Description	Each coupler is associated with an input number

Variable	CANopen OUT 3 (3161)
Unit	-
Min	0
Max	32
Init	0
Description	Each coupler is associated with output number

Coupler 4

Variable	Coupler ID # 4 (3162)
Unit	-
Min	0
Max	255
Init	0
Description	Coupler identifier, In client Config mode, we can add several couplers and for each coupler a unique identifier is dedicated by the client

Variable	CANopen IN 4 (3163)
Unit	-
Min	0
Max	32
Init	0
Description	Each coupler is associated with an input number

Variable	CANopen OUT 4 (3164)
Unit	-
Min	0
Max	32
Init	0
Description	Each coupler is associated with output number

CANopen outputs

Variable	CANopen digital output n°1 (4751)
Unit	-
Min	0
Max	1
Init	-
Description	CANopen digital output 1

Variable	CANopen digital output n°2 (4752)
Unit	-
Min	0
Max	1
Init	-
Description	CANopen digital output 2

Variable	CANopen digital output n°3 (4753)
Unit	-
Min	0
Max	1
Init	-
Description	CANopen digital output 3

Variable	CANopen digital output n°4 (4754)
Unit	-
Min	0
Max	1
Init	-
Description	CANopen digital output 4

Variable	CANopen digital output n°5 (4755)
Unit	-
Min	0
Max	1
Init	-
Description	CANopen digital output 5

Variable	CANopen digital output n°6 (4756)
Unit	-
Min	0
Max	1
Init	-
Description	CANopen digital output 6

Variable	CANopen digital output n°7 (4757)
Unit	-
Min	0
Max	1
Init	-
Description	CANopen digital output 7

Variable	CANOpen digital output n°8 (4758)
Unit	-
Min	0
Max	1
Init	-
Description	CANOpen digital output 8

Variable	CANOpen digital output n°9 (4759)
Unit	-
Min	0
Max	1
Init	-
Description	CANOpen digital output 9

Variable	CANOpen digital output n°10 (4760)
Unit	-
Min	0
Max	1
Init	-
Description	CANOpen digital output 10

Variable	CANOpen digital output n°11 (4761)
Unit	-
Min	0
Max	1
Init	-
Description	CANOpen digital output 11

Variable	CANOpen digital output n°12 (4762)
Unit	-
Min	0
Max	1
Init	-
Description	CANOpen digital output 12

Variable	CANOpen digital output n°13 (4763)
Unit	-
Min	0
Max	1
Init	-
Description	CANOpen digital output 13

Variable	CANOpen digital output n°14 (4764)
Unit	-
Min	0
Max	1
Init	-
Description	CANOpen digital output 14

Variable	CANOpen digital output n°15 (4765)
Unit	-
Min	0
Max	1
Init	-
Description	CANOpen digital output 15

Variable	CANOpen digital output n°16 (4766)
Unit	-
Min	0
Max	1
Init	-
Description	CANOpen digital output 16

Variable	CANOpen digital output n°17 (4767)
Unit	-
Min	0
Max	1
Init	-
Description	CANOpen digital output 17

Variable	CANOpen digital output n°18 (4768)
Unit	-
Min	0
Max	1
Init	-
Description	CANOpen digital output 18

Variable	CANOpen digital output n°19 (4769)
Unit	-
Min	0
Max	1
Init	-
Description	CANOpen digital output 19

Variable	CANOpen digital output n°20 (4770)
Unit	-
Min	0
Max	1
Init	-
Description	CANOpen digital output 20

Variable	CANOpen digital output n°21 (4771)
Unit	-
Min	0
Max	1
Init	-
Description	CANOpen digital output 21

Variable	CANOpen digital output n°22 (4772)
Unit	-
Min	0
Max	1
Init	-
Description	CANOpen digital output 22

Variable	CANOpen digital output n°23 (4773)
Unit	-
Min	0
Max	1
Init	-
Description	CANOpen digital output 23

Variable	CANOpen digital output n°24 (4774)
Unit	-
Min	0
Max	1
Init	-
Description	CANOpen digital output 24

Variable	CANOpen digital output n°25 (4775)
Unit	-
Min	0
Max	1
Init	-
Description	CANOpen digital output 25

Variable	CANOpen digital output n°26 (4776)
Unit	-
Min	0
Max	1
Init	-
Description	CANOpen digital output 26

Variable	CANOpen digital output n°27 (4777)
Unit	-
Min	0
Max	1
Init	-
Description	CANOpen digital output 27

Variable	CANOpen digital output n°28 (4778)
Unit	-
Min	0
Max	1
Init	-
Description	CANOpen digital output 28

Variable	CANOpen digital output n°29 (4779)
Unit	-
Min	0
Max	1
Init	-
Description	CANOpen digital output 29

Variable	CANOpen digital output n°30 (4780)
Unit	-
Min	0
Max	1
Init	-
Description	CANOpen digital output 30

Variable	CANOpen digital output n°31 (4781)
Unit	-
Min	0
Max	1
Init	-
Description	CANOpen digital output 31

Variable	CANopen digital output n°32 (4782)
Unit	-
Min	0
Max	1
Init	-
Description	CANopen digital output 32

Timers

Variable	Horn Timer (2478)
Unit	s
Min	0.0
Max	6553.5
Init	10
Description	Trigger time Horn. 0 means the horn will buzz until being manually stopped.

Synchronization

Variable	Voltage acceptance (2800)
Unit	%
Min	0.0
Max	12.0
Init	50
Description	Voltage acceptance for synchronization between gensets (or genset/mains)

Variable	Frequency acceptance (2801)
Unit	Hz
Min	0.00
Max	0.20
Init	10
Description	Frequency acceptance for synchronization between gensets (or genset/mains)

Variable	Phase Angle acceptance (2802)
Unit	°
Min	0
Max	30
Init	10
Description	Phase Angle acceptance for synchronization between gensets (or genset/mains)

Variable	Fail to synchronize timer (2803)
Unit	s
Min	0.0
Max	999.9
Init	1200
Description	Timer max for synchronisation

Variable	Control on fail to synchronize (2804)
Unit	-
Min	0
Max	7
Init	3
Description	Validation fail to synch (Default value=Alarm)

Logger

Activation

Variable	Activation (3610)
Unit	-
Min	0
Max	3
Init	0
Description	Archiving mode OFF = NEVER / ALWAYS / POST STARTING / STABILIZED, event archiving can be activated depending on engine status. Warning : erase will delete all faults, alarms and archived data.

Variables 1-5

Log 1

Variable	Variable (3600)
Unit	-
Min	0
Max	65 535
Init	0
Description	Logger of the variable to archive

Variable	Log on (3622)
Unit	-
Min	0
Max	1
Init	0
Description	A variable can be logged in two different ways : - Interval : The variable will be logged at specific intervals, defined by the user ([3612]) - Value change : The variable will be logged each time the value of the variable has been changed

Variable	Period (3612)
Unit	s
Min	1
Max	9999
Init	1
Description	Time in second of interval between each archiving

Log 2

Variable	Variable (3601)
Unit	-
Min	0
Max	65 535
Init	0
Description	Logger of the variable to archive

Variable	Log on (3623)
Unit	-
Min	0
Max	1
Init	0
Description	A variable can be logged in two different ways : - Interval : The variable will be logged at a periodic interval, defined by the user ([3613]) - Value change : The variable will be logged each time the value of the variable has been changed

Variable	Period (3613)
Unit	s
Min	1
Max	9999
Init	1
Description	Time in second of interval between each archiving

Log 3

Variable	Variable (3602)
Unit	-
Min	0
Max	65 535
Init	0
Description	Logger of the variable to archive

Variable	Log on (3624)
Unit	-
Min	0
Max	1
Init	0
Description	A variable can be logged in two different ways : - Interval : The variable will be logged at a periodic interval, defined by the user ([3614]) - Value change : The variable will be logged each time the value of the variable has been changed

Variable	Period (3614)
Unit	s
Min	1
Max	9999
Init	1
Description	Time in second of interval between each archiving

Log 4

Variable	Variable (3603)
Unit	-
Min	0
Max	65 535
Init	0
Description	Logger of the variable to archive

Variable	Log on (3625)
Unit	-
Min	0
Max	1
Init	0
Description	A variable can be logged in two different ways : - Interval : The variable will be logged at a periodic interval, defined by the user ([3615]) - Value change : The variable will be logged each time the value of the variable has been changed

Variable	Period (3615)
Unit	s
Min	1
Max	9999
Init	1
Description	Time in second of interval between each archiving

Log 5

Variable	Variable (3604)
Unit	-
Min	0
Max	65 535
Init	0
Description	Logger of the variable to archive

Variable	Log on (3626)
Unit	-
Min	0
Max	1
Init	0
Description	A variable can be logged in two different ways : - Interval : The variable will be logged at a periodic interval, defined by the user ([3616]) - Value change : The variable will be logged each time the value of the variable has been changed

Variable	Period (3616)
Unit	s
Min	1
Max	9999
Init	1
Description	Time in second of interval between each archiving

Variables 6-10

Log 6

Variable	Variable (3605)
Unit	-
Min	0
Max	65 535
Init	0
Description	Logger of the variable to archive

Variable	Log on (3627)
Unit	-
Min	0
Max	1
Init	0
Description	A variable can be logged in two different ways : - Interval : The variable will be logged at a periodic interval, defined by the user ([3617]) - Value change : The variable will be logged each time the value of the variable has been changed

Variable	Period (3617)
Unit	s
Min	1
Max	9999
Init	1
Description	Time in second of interval between each archiving

Log 7

Variable	Variable (3606)
Unit	-
Min	0
Max	65 535
Init	0
Description	Logger of the variable to archive

Variable	Log on (3628)
Unit	-
Min	0
Max	1
Init	0
Description	A variable can be logged in two different ways : - Interval : The variable will be logged at a periodic interval, defined by the user ([3618]) - Value change : The variable will be logged each time the value of the variable has been changed

Variable	Period (3618)
Unit	s
Min	1
Max	9999
Init	1
Description	Time in second of interval between each archiving

Log 8

Variable	Variable (3607)
Unit	-
Min	0
Max	65 535
Init	0
Description	Logger of the variable to archive

Variable	Log on (3629)
Unit	-
Min	0
Max	1
Init	0
Description	A variable can be logged in two different ways : - Interval : The variable will be logged at a periodic interval, defined by the user ([3619]) - Value change : The variable will be logged each time the value of the variable has been changed

Variable	Period (3619)
Unit	s
Min	1
Max	9999
Init	1
Description	Time in second of interval between each archiving

Log 9

Variable	Variable (3608)
Unit	-
Min	0
Max	65 535
Init	0
Description	Logger of the variable to archive

Variable	Log on (3630)
Unit	-
Min	0
Max	1
Init	0
Description	A variable can be logged in two different ways : - Interval : The variable will be logged at a periodic interval, defined by the user ([3620]) - Value change : The variable will be logged each time the value of the variable has been changed

Variable	Period (3620)
Unit	s
Min	1
Max	9999
Init	1
Description	Time in second of interval between each archiving

Log 10

Variable	Variable (3609)
Unit	-
Min	0
Max	65 535
Init	0
Description	Logger of the variable to archive

Variable	Log on (3631)
Unit	-
Min	0
Max	1
Init	0
Description	A variable can be logged in two different ways : - Interval : The variable will be logged at a periodic interval, defined by the user ([3621]) - Value change : The variable will be logged each time the value of the variable has been changed

Variable	Period (3621)
Unit	s
Min	1
Max	9999
Init	1
Description	Time in second of interval between each archiving

Modbus redirection

Variable	Modbus 000 (10000)
Unit	-
Min	0
Max	65 535
Init	0
Description	Modbus redirection variable, allows to redirect a variable to the modbus address 10,000

List of inputs/outputs - Bitfields

List of inputs	127
Generator breaker feedback (4501)	127
Fault reset (4506)	127
Generator fault request (4507)	127
Increase speed in manual mode (4514)	127
Decrease speed in manual mode (4515)	127
Increase voltage in manual mode (4516)	127
Decrease voltage in manual mode (4517)	127
Remote alarm (4527)	127
Stop horn (4530)	127
Speed setpoint 2 selection (4535)	127
Module activation digital input (4579)	127
Alternative selection 1 (4594)	127
Alternative selection 2 (4595)	127
Alternative selection 3 (4596)	127
Alternative selection 4 (4597)	127
Alternative selection 5 (4598)	128
Alternative selection 6 (4599)	128
Alternative selection 7 (4600)	128
Alternative selection 8 (4601)	128
Alternative selection 9 (4602)	128
Alternative selection 10 (4603)	128
Alternative selection 11 (4604)	128
Alternative selection 12 (4605)	128
Alternative selection 13 (4606)	128
Alternative selection 14 (4607)	128
Alternative selection 15 (4608)	128
Alternative selection 16 (4609)	128
Hysteresis low threshold DI1 (4614)	128
Hysteresis low threshold DI2 (4615)	128
Hysteresis low threshold DI3 (4616)	128
Hysteresis low threshold DI4 (4617)	128
Hysteresis low threshold DI5 (4618)	129
Hysteresis low threshold DI6 (4619)	129
Hysteresis low threshold DI7 (4620)	129
Hysteresis low threshold DI8 (4621)	129
Hysteresis high threshold DI1 (4622)	129
Hysteresis high threshold DI2 (4623)	129
Hysteresis high threshold DI3 (4624)	129
Hysteresis high threshold DI4 (4625)	129
Hysteresis high threshold DI5 (4626)	129
Hysteresis high threshold DI6 (4627)	129
Hysteresis high threshold DI7 (4628)	129
Hysteresis high threshold DI8 (4629)	129
Digital output 1 forced (4630)	129
Digital output 2 forced (4631)	129
Digital output 3 forced (4632)	129
Digital output 4 forced (4633)	129
Digital output 5 forced (4634)	130
Digital output 6 forced (4635)	130
Relay 1 forced (4950)	130
Relay 2 forced (4951)	130

List of outputs	130
Phase sequence match (306)	130
Voltage match (307)	130
Frequency match (308)	130
Phase match (309)	130
Authorization to close breaker (310)	130
Isolated product (sees nothing on CAN bus) (600)	130
Missing product (atleast one product is missing on CAN bus) (605)	130
Fail to synchronize (4051)	130
Breaker fault (4152)	130
Breaker alarm (4153)	130
Fail to close generator breaker (4154)	130
Battery minimum voltage (4202)	131
Battery maximum voltage (4203)	131
AN1 min/max (Customisable) (4206)	131
AN2 min/max (Customisable) (4207)	131
AN3 min/max (Customisable) (4208)	131
Minimum speed output (4209)	131
Maximum speed output (4210)	131
Minimum AVR output (4211)	131
Maximum AVR output (4212)	131
Generator over frequency (4250)	131
Generator under frequency (4251)	131
Generator over voltage (4252)	131
Generator under voltage (4253)	131
Uneven speed output deviation fault (4265)	131
Uneven AVR output deviation fault (4266)	132
Generator voltage unbalance (4268)	132
Generator electrical faults summary (4656)	132
Alarms summary (4658)	132
Horn (4663)	132
Default LED (4664)	132
Alarm LED (4665)	132
Generator LED (4669)	132
Generator ready (4670)	132
Generator voltage present (4671)	132
Generator stop (4673)	132
Generator breaker close (4675)	132
Increase speed by pulse (4699)	132
Decrease speed by pulse (4700)	132
Increase voltage by pulse (4701)	132
Decrease voltage by pulse (4702)	133
Bus/Mains voltage presence (4703)	133
End state (4705)	133
Battery boost DO (4709)	133
Hysteresis output activation on AI1 (4710)	133
Hysteresis output activation on AI2 (4711)	133
Hysteresis output activation on AI3 (4712)	133
Hysteresis output activation on DI1 (4713)	133
Hysteresis output activation on DI2 (4714)	133
Hysteresis output activation on DI3 (4715)	133
Hysteresis output activation on DI4 (4716)	133
Hysteresis output activation on DI5 (4717)	133
Hysteresis output activation on DI6 (4718)	133
Hysteresis output activation on DI7 (4719)	133
Hysteresis output activation on DI8 (4720)	133
CANopen fault (4750)	133

Bitfields	134
SYSTEM INFO (E00950)	134
KEY INHIBITION STATUS (E00951)	134
LED STATUS (E00952)	134
Digital input raw (E00953)	135
E00954 (Processed)	135
E00955 (Processed)	135
E00956 (Processed)	136
E00957 (Processed)	136
E00958 (Processed)	136
E00959 (Processed)	137
RESET MAINTENANCE & METERS (E10400)	137
RESET MAINTENANCE & METERS 2 (E10401)	137
KEY INHIBITION (E8102)	138
MODBUS ACCESS (E3015)	138
E00960 (Alarm)	138
E00961 (Fault)	139
E00962 (Alarm)	139
E00963 (Fault)	139
E00964 (Alarm)	140
E00965 (Fault)	140
E00966 (Alarm)	140
E00967 (Fault)	141
E00968 (Alarm)	141
E00969 (Fault)	141
E00970 (Alarm)	142
E00971 (Fault)	142
E00972 (Alarm)	142
E00973 (Fault)	143
E00974 (Alarm)	143
E00975 (Fault)	143

List of inputs

Variable	Generator breaker feedback (4501)
Description	Generator breaker position feedback

Variable	Fault reset (4506)
Description	External reset. Alternative to local fault reset in Fault and Alarm pages.

Variable	Generator fault request (4507)
Description	Fault raised by the generator

Variable	Increase speed in manual mode (4514)
Description	Remote frequency increase command (alternative to front button)

Variable	Decrease speed in manual mode (4515)
Description	Remote frequency decrease command (alternative to front button)

Variable	Increase voltage in manual mode (4516)
Description	Remote voltage increase command (alternative to front button)

Variable	Decrease voltage in manual mode (4517)
Description	Remote voltage decrease command (alternative to front button)

Variable	Remote alarm (4527)
Description	If external protections are installed, to report an alarm

Variable	Stop horn (4530)
Description	Selective external reset, in addition, an output must be preset to Horn.

Variable	Speed setpoint 2 selection (4535)
Description	Speed setpoint 2 selection

Variable	Module activation digital input (4579)
Description	Module activation digital input

Variable	Alternative selection 1 (4594)
Description	1st available variable to switch a parameter between 2 values

Variable	Alternative selection 2 (4595)
Description	2nd available variable to switch a parameter between 2 values

Variable	Alternative selection 3 (4596)
Description	3rd available variable to switch a parameter between 2 values

Variable	Alternative selection 4 (4597)
Description	4th available variable to switch a parameter between 2 values

Variable	Alternative selection 5 (4598)
Description	5th available variable to switch a parameter between 2 values
Variable	Alternative selection 6 (4599)
Description	6th available variable to switch a parameter between 2 values
Variable	Alternative selection 7 (4600)
Description	7th available variable to switch a parameter between 2 values
Variable	Alternative selection 8 (4601)
Description	8th available variable to switch a parameter between 2 values
Variable	Alternative selection 9 (4602)
Description	9th available variable to switch a parameter between 2 values
Variable	Alternative selection 10 (4603)
Description	10th available variable to switch a parameter between 2 values
Variable	Alternative selection 11 (4604)
Description	11th available variable to switch a parameter between 2 values
Variable	Alternative selection 12 (4605)
Description	12th available variable to switch a parameter between 2 values
Variable	Alternative selection 13 (4606)
Description	13th available variable to switch a parameter between 2 values
Variable	Alternative selection 14 (4607)
Description	14th available variable to switch a parameter between 2 values
Variable	Alternative selection 15 (4608)
Description	15th available variable to switch a parameter between 2 values
Variable	Alternative selection 16 (4609)
Description	16th available variable to switch a parameter between 2 values
Variable	Hysteresis low threshold DI1 (4614)
Description	Digital input : Low threshold 1
Variable	Hysteresis low threshold DI2 (4615)
Description	Digital input : Low threshold 2
Variable	Hysteresis low threshold DI3 (4616)
Description	Digital input : Low threshold 3
Variable	Hysteresis low threshold DI4 (4617)
Description	Digital input : Low threshold 4

Variable	Hysteresis low threshold DI5 (4618)
Description	Digital input : Low threshold 5
Variable	Hysteresis low threshold DI6 (4619)
Description	Digital input : Low threshold 6
Variable	Hysteresis low threshold DI7 (4620)
Description	Digital input : Low threshold 7
Variable	Hysteresis low threshold DI8 (4621)
Description	Digital input : Low threshold 8
Variable	Hysteresis high threshold DI1 (4622)
Description	Digital input : High threshold 1
Variable	Hysteresis high threshold DI2 (4623)
Description	Digital input : High threshold 2
Variable	Hysteresis high threshold DI3 (4624)
Description	Digital input : High threshold 3
Variable	Hysteresis high threshold DI4 (4625)
Description	Digital input : High threshold 4
Variable	Hysteresis high threshold DI5 (4626)
Description	Digital input : High threshold 5
Variable	Hysteresis high threshold DI6 (4627)
Description	Digital input : High threshold 6
Variable	Hysteresis high threshold DI7 (4628)
Description	Digital input : High threshold 7
Variable	Hysteresis high threshold DI8 (4629)
Description	Digital input : High threshold 8
Variable	Digital output 1 forced (4630)
Description	Digital output 1 forced
Variable	Digital output 2 forced (4631)
Description	Digital output 2 forced
Variable	Digital output 3 forced (4632)
Description	Digital output 3 forced
Variable	Digital output 4 forced (4633)
Description	Digital output 4 forced

Variable	Digital output 5 forced (4634)
Description	Digital output 5 forced

Variable	Digital output 6 forced (4635)
Description	Digital output 6 forced

Variable	Relay 1 forced (4950)
Description	Relay 1 forced

Variable	Relay 2 forced (4951)
Description	Relay 2 forced

List of outputs

Variable	Phase sequence match (306)
Description	Phase sequences are the same for synchronization (OK = 1 or Not OK = 0)

Variable	Voltage match (307)
Description	Voltages are close enough for synchronization (OK = 1 or Not OK = 0)

Variable	Frequency match (308)
Description	Frequencies are close enough for synchronization (OK = 1 or Not OK = 0)

Variable	Phase match (309)
Description	Phases are close enough for synchronization (OK = 1 or Not OK = 0)

Variable	Authorization to close breaker (310)
Description	Synchronization request accepted (OK = 1 or Not OK = 0)

Variable	Isolated product (sees nothing on CAN bus) (600)
Description	Isolated product (Product alone on the bus CAN)

Variable	Missing product (atleast one product is missing on CAN bus) (605)
Description	Missing product (One or several products are missing)

Variable	Fail to synchronize (4051)
Description	Synchronization request denied (PID setting, fail to close breaker)

Variable	Breaker fault (4152)
Description	Control a breaker fault

Variable	Breaker alarm (4153)
Description	Control a breaker alarm

Variable	Fail to close generator breaker (4154)
Description	Fail to close generator breaker

Variable	Battery minimum voltage (4202)
Description	Battery min volt

Variable	Battery maximum voltage (4203)
Description	Battery max Volt

Variable	AN1 min/max (Customisable) (4206)
Description	This value is to customize the label of analog input 1 protection. The maximum number of characters is of 14. This protection use the analog input 1 set in the "Analog inputs" chapter (variable 150).

Variable	AN2 min/max (Customisable) (4207)
Description	This value is to customize the label of analog input 2 protection. The maximum number of characters is of 14. This protection use the analog input 2 set in the "Analog inputs" chapter (variable 151).

Variable	AN3 min/max (Customisable) (4208)
Description	This value is to customize the label of analog input 3 protection. The maximum number of characters is of 14. This protection use the analog input 3 set in the "Analog inputs" chapter (variable 152).

Variable	Minimum speed output (4209)
Description	Minimum speed output

Variable	Maximum speed output (4210)
Description	Maximum speed output

Variable	Minimum AVR output (4211)
Description	Minimum AVR output

Variable	Maximum AVR output (4212)
Description	Maximum AVR output

Variable	Generator over frequency (4250)
Description	Generator over frequency

Variable	Generator under frequency (4251)
Description	Generator under frequency

Variable	Generator over voltage (4252)
Description	Generator over voltage

Variable	Generator under voltage (4253)
Description	Generator under voltage

Variable	Uneven speed output deviation fault (4265)
Description	Uneven speed output deviation fault

Variable	Uneven AVR output deviation fault (4266)
Description	Uneven AVR output deviation fault
Variable	Generator voltage unbalance (4268)
Description	Generator voltage unbalance
Variable	Generator electrical faults summary (4656)
Description	External panel. Trigger : at least one generator-detected "fault"
Variable	Alarms summary (4658)
Description	External panel. Trigger : at least one generator-detected "alarm"
Variable	Horn (4663)
Description	External horn or flashing light. Activated whenever a protection triggers. The output is activated when one or more of summary outputs is activated, and reset on acknowledgment.
Variable	Default LED (4664)
Description	Fault LED
Variable	Alarm LED (4665)
Description	Alarm LED
Variable	Generator LED (4669)
Description	Generator LED
Variable	Generator ready (4670)
Description	Activated if start sequence is completed & voltage is present in generator. The output is activated when engine state is "Generator ready".
Variable	Generator voltage present (4671)
Description	Activated if the generator is started and a voltage is detected
Variable	Generator stop (4673)
Description	Activated if generator is at rest
Variable	Generator breaker close (4675)
Description	Command to close generator breaker
Variable	Increase speed by pulse (4699)
Description	Speed regulator requiring +/- contacts. In manual mode, the output is activated when you press the "top arrow" key or with an "Increase speed in manual mode"
Variable	Decrease speed by pulse (4700)
Description	Speed regulator requiring +/- contacts. In manual mode, the output is activated when you press the "bottom arrow" key or with an "Decrease speed in manual mode"
Variable	Increase voltage by pulse (4701)
Description	Voltage regulator requiring +/- contacts. In manual mode, the output is activated when you press the "top arrow" key or with an "Increase voltage in manual mode"

Variable	Decrease voltage by pulse (4702)
Description	Voltage regulator requiring +/- contacts. In manual mode, the output is activated when you press the "bottom arrow" key or with an "Decrease voltage in manual mode"
Variable	Bus/Mains voltage presence (4703)
Description	Activated when mains is present, wholesome (i.e after mains back delay [2009] occurred) and no mains electrical fault activated.
Variable	End state (4705)
Description	End state : Restart the engine or press reset
Variable	Battery boost DO (4709)
Description	Battery boost digital output
Variable	Hysteresis output activation on AI1 (4710)
Description	Analog 1 digital output
Variable	Hysteresis output activation on AI2 (4711)
Description	Analog 2 digital output
Variable	Hysteresis output activation on AI3 (4712)
Description	Analog 3 digital output
Variable	Hysteresis output activation on DI1 (4713)
Description	Digital output activation on digital input 1
Variable	Hysteresis output activation on DI2 (4714)
Description	Digital output activation on digital input 2
Variable	Hysteresis output activation on DI3 (4715)
Description	Digital output activation on digital input 3
Variable	Hysteresis output activation on DI4 (4716)
Description	Digital output activation on digital input 4
Variable	Hysteresis output activation on DI5 (4717)
Description	Digital output activation on digital input 5
Variable	Hysteresis output activation on DI6 (4718)
Description	Digital output activation on digital input 6
Variable	Hysteresis output activation on DI7 (4719)
Description	Digital output activation on digital input 7
Variable	Hysteresis output activation on DI8 (4720)
Description	Digital output activation on digital input 8
Variable	CANopen fault (4750)
Description	CANopen bus fault (not present)

Bitfields

SYSTEM INFO (E00950)	
Bit	Description
15	-
14	-
13	-
12	-
11	-
10	-
9	-
8	-
7	-
6	-
5	-
4	Engine running
3	Alarm exist : Alarm LED is on
2	Fault exist : Fault LED is on
1	New alarm occured : Alarm LED is blinking
0	New fault occured : Fault LED is blinking

KEY INHIBITION STATUS (E00951)	
Bit	Description
15	-
14	Auto
13	Test
12	Man
11	Start
10	Stop
9	Generator(AMF/MAINS/PRIME)/bus(MASTER/BTB) open/close breaker
8	Mains(AMF/MAINS/MASTER/MASTER 1 B only) open/close breaker
7	Fault/Alarm/info
6	Esc
5	Enter
4	High arrows
3	Left arrows
2	Low arrows
1	Right arrows
0	Shift

LED STATUS (E00952)	
Bit	Description
15	-
14	-
13	-
12	-
11	-
10	-
9	-
8	Generator (AMF/MAINS/PRIME/SYNCHRO) /bus (MASTER/MASTER 1B) voltage
7	Alarm
6	Generator (AMF/PRIME/MAINS) /bus (BTB/MASTER) breaker
5	TEST
4	Mains breaker (AMF/MAINS/MASTER/MASTER 1B only)
3	MAN
2	AUTO
1	Bus voltage (SYNCHRO/PRIME/BTB) / Mains voltage (AMF/MAINS/MASTER/MASTER 1B)
0	Fault

Digital input raw (E00953)	
Bit	Description
15	-
14	-
13	-
12	-
11	Analog 3 setup as digital input
10	Analog 2 setup as digital input
9	Analog 1 setup as digital input
8	Digital input 9 on hardware
7	Digital input 8 on hardware
6	Digital input 7 on hardware
5	Digital input 6 on hardware
4	Digital input 5 on hardware
3	Digital input 4 on hardware
2	Digital input 3 on hardware
1	Digital input 2 on hardware
0	Digital input 1 on hardware

E00954 (Processed)	
Bit	Description
15	-
14	-
13	-
12	-
11	Analog input 3 setup as digital input
10	Analog input 2 setup as digital input
9	Analog input 1 setup as digital input
8	Digital input 9
7	Digital input 8
6	Digital input 7
5	Digital input 6
4	Digital input 5
3	Digital input 4
2	Digital input 3
1	Digital input 2
0	Digital input 1

E00955 (Processed)	
Bit	Description
15	CANopen digital Input 16
14	CANopen digital Input 15
13	CANopen digital Input 14
12	CANopen digital Input 13
11	CANopen digital Input 12
10	CANopen digital Input 11
9	CANopen digital Input 10
8	CANopen digital Input 9
7	CANopen digital Input 8
6	CANopen digital Input 7
5	CANopen digital Input 6
4	CANopen digital Input 5
3	CANopen digital Input 4
2	CANopen digital Input 3
1	CANopen digital Input 2
0	CANopen digital Input 1

E00956 (Processed)	
Bit	Description
15	CANopen digital Input 32
14	CANopen digital Input 31
13	CANopen digital Input 30
12	CANopen digital Input 29
11	CANopen digital Input 28
10	CANopen digital Input 27
9	CANopen digital Input 26
8	CANopen digital Input 25
7	CANopen digital Input 24
6	CANopen digital Input 23
5	CANopen digital Input 22
4	CANopen digital Input 21
3	CANopen digital Input 20
2	CANopen digital Input 19
1	CANopen digital Input 18
0	CANopen digital Input 17

E00957 (Processed)	
Bit	Description
15	-
14	-
13	-
12	-
11	-
10	-
9	-
8	-
7	Relay 2
6	Relay 1
5	Digital output 6
4	Digital output 5
3	Digital output 4
2	Digital output 3
1	Digital output 2
0	Digital output 1

E00958 (Processed)	
Bit	Description
15	CANopen digital Output 16
14	CANopen digital Output 15
13	CANopen digital Output 14
12	CANopen digital Output 13
11	CANopen digital Output 12
10	CANopen digital Output 11
9	CANopen digital Output 10
8	CANopen digital Output 9
7	CANopen digital Output 8
6	CANopen digital Output 7
5	CANopen digital Output 6
4	CANopen digital Output 5
3	CANopen digital Output 4
2	CANopen digital Output 3
1	CANopen digital Output 2
0	CANopen digital Output 1

E00959 (Processed)	
Bit	Description
15	CANopen digital Output 32
14	CANopen digital Output 31
13	CANopen digital Output 30
12	CANopen digital Output 29
11	CANopen digital Output 28
10	CANopen digital Output 27
9	CANopen digital Output 26
8	CANopen digital Output 25
7	CANopen digital Output 24
6	CANopen digital Output 23
5	CANopen digital Output 22
4	CANopen digital Output 21
3	CANopen digital Output 20
2	CANopen digital Output 19
1	CANopen digital Output 18
0	CANopen digital Output 17

RESET MAINTENANCE & METERS (E10400)	
Bit	Description
15	Meters : Generator total kWh
14	Meters : Generator total kVARh
13	Meters : Mains total kWh
12	Meters : Mains total kVARh
11	Meters : Engine running hours
10	Meters : Number of attempts to start
9	Maintenance cycle 5 in days
8	Maintenance cycle 4 in days
7	Maintenance cycle 3 in days
6	Maintenance cycle 2 in days
5	Maintenance cycle 1 in days
4	Maintenance cycle 5 in hours
3	Maintenance cycle 4 in hours
2	Maintenance cycle 3 in hours
1	Maintenance cycle 2 in hours
0	Maintenance cycle 1 in hours

RESET MAINTENANCE & METERS 2 (E10401)	
Bit	Description
15	-
14	-
13	-
12	-
11	-
10	-
9	-
8	-
7	-
6	-
5	-
4	-
3	-
2	-
1	Override hours
0	Generator auxiliary run hours

KEY INHIBITION (E8102)	
Bit	Description
15	-
14	Auto
13	Test
12	Man
11	Start
10	Stop
9	Generator(AMF/MAINS/PRIME)/bus(MASTER/BTB) open/close breaker
8	Mains(AMF/MAINS/MASTER/MASTER 1 B only) open/close breaker
7	Fault/Alarm/info
6	Esc
5	Enter
4	High arrows
3	Left arrows
2	Low arrows
1	Right arrows
0	Shift

MODBUS ACCESS (E3015)	
Bit	Description
15	-
14	-
13	-
12	-
11	-
10	-
9	Writing using Modbus/tcp
8	Reading using Modbus/tcp
7	-
6	-
5	-
4	-
3	Writing to input functions
2	-
1	Writing to engine meters
0	Writing to date/time

E00960 (Alarm)		
Bit	Var	Description
15	4171	Bus breaker close suddently
14	4159	Bus breaker open suddently
13	4158	Fail to open bus breaker
12	4157	Fail to close bus breaker
11	4205	Engine maximum water temperature level 2
10	4205	Engine maximum water temperature level 1
9	4204	Engine minimum oil pressure level 2
8	4204	Engine minimum oil pressure level 1
7	4203	Engine battery max volt level 2
6	4203	Engine battery max volt level 1
5	4202	Engine battery min volt level 2
4	4202	Engine battery min volt level 1
3	4201	Engine under speed level 2
2	4201	Engine under speed level1
1	4200	Engine overspeed level2
0	4200	Engine overspeed level1

E00961 (Fault)		
Bit	Var	Description
15	4171	Bus breaker close suddently
14	4159	Bus breaker open suddently
13	4158	Fail to open bus breaker
12	4157	Fail to close bus breaker
11	4205	Engine maximum water temperature level 2
10	4205	Engine maximum water temperature level 1
9	4204	Engine minimum oil pressure level 2
8	4204	Engine minimum oil pressure level 1
7	4203	Engine battery max volt level 2
6	4203	Engine battery max volt level 1
5	4202	Engine battery min volt level 2
4	4202	Engine battery min volt level 1
3	4201	Engine under speed level 2
2	4201	Engine under speed level1
1	4200	Engine overspeed level2
0	4200	Engine overspeed level1

E00962 (Alarm)		
Bit	Var	Description
15	4257	Generator/Power plant minimum kVAR level2
14	4257	Generator/Power plant minimum kVAR level1
13	4256	Generator/Power plant reverse kW level2
12	4256	Generator/Power plant reverse kW level1
11	4255	Generator/Power plant maximum kW level2
10	4255	Generator/Power plant maximum kW level1
9	4254	Generator/Power plant minimum kW level2
8	4254	Generator/Power plant minimum kW level1
7	4253	Generator/Power plant under voltage level2
6	4253	Generator/Power plant under voltage level1
5	4252	Generator/Power plant over voltage level2
4	4252	Generator/Power plant over voltage level1
3	4251	Generator/Power plant under frequency level 2
2	4251	Generator/Power plant under frequency level1
1	4250	Generator/Power plant over frequency level2
0	4250	Generator/Power plant over frequency level1

E00963 (Fault)		
Bit	Var	Description
15	4257	Generator/Power plant minimum kVAR level2
14	4257	Generator/Power plant minimum kVAR level1
13	4256	Generator/Power plant reverse kW level2
12	4256	Generator/Power plant reverse kW level1
11	4255	Generator/Power plant maximum kW level2
10	4255	Generator/Power plant maximum kW level1
9	4254	Generator/Power plant minimum kW level2
8	4254	Generator/Power plant minimum kW level1
7	4253	Generator/Power plant under voltage level2
6	4253	Generator/Power plant under voltage level1
5	4252	Generator/Power plant over voltage level2
4	4252	Generator/Power plant over voltage level1
3	4251	Generator/Power plant under frequency level 2
2	4251	Generator/Power plant under frequency level1
1	4250	Generator/Power plant over frequency level2
0	4250	Generator/Power plant over frequency level1

E00964 (Alarm)		
Bit	Var	Description
15	4267	Earth fault level 2
14	4267	Earth fault level 1
13	4112	Last trip out
12	4266	Uneven voltage
11	4265	Uneven speed
10	4264	Uneven kVAR
9	4263	Uneven kW
8	4262	Generator overcurrent
7	4261	Generator maximum neutral current level2
6	4261	Generator maximum neutral current level1
5	4260	Generator maximum current level2
4	4260	Generator maximum current level1
3	4259	Generator/Power plant reverse kVAR level2
2	4259	Generator/Power plant reverse kVAR level1
1	4258	Generator/Power plant maximum kVAR level2
0	4258	Generator/Power plant maximum kVAR level1

E00965 (Fault)		
Bit	Var	Description
15	4267	Earth fault level 2
14	4267	Earth fault level 1
13	4112	Last trip out
12	4266	Uneven voltage
11	4265	Uneven speed
10	4264	Uneven kVAR
9	4263	Uneven kW
8	4262	Generator overcurrent
7	4261	Generator maximum neutral current level2
6	4261	Generator maximum neutral current level1
5	4260	Generator maximum current level2
4	4260	Generator maximum current level1
3	4259	Generator/Power plant reverse kVAR level2
2	4259	Generator/Power plant reverse kVAR level1
1	4258	Generator/Power plant maximum kVAR level2
0	4258	Generator/Power plant maximum kVAR level1

E00966 (Alarm)		
Bit	Var	Description
15	4307	Bus/Mains minimum kVAR level2
14	4307	Bus/Mains minimum kVAR level1
13	4306	Bus/Mains reverse kW level2
12	4306	Bus/Mains reverse kW level1
11	4305	Bus/Mains maximum kW level2
10	4305	Bus/Mains maximum kW level1
9	4304	Bus/Mains minimum kW level2
8	4304	Bus/Mains minimum kW level1
7	4303	Bus/Mains under voltage level2
6	4303	Bus/Mains under voltage level1
5	4302	Bus/Mains over voltage level2
4	4302	Bus/Mains over voltage level1
3	4301	Bus/Mains under frequency level 2
2	4301	Bus/Mains under frequency level1
1	4300	Bus/Mains over frequency level2
0	4300	Bus/Mains over frequency level1

E00967 (Fault)		
Bit	Var	Description
15	4307	Bus/Mains minimum kVAR level2
14	4307	Bus/Mains minimum kVAR level1
13	4306	Bus/Mains reverse kW level2
12	4306	Bus/Mains reverse kW level1
11	4305	Bus/Mains maximum kW level2
10	4305	Bus/Mains maximum kW level1
9	4304	Bus/Mains minimum kW level2
8	4304	Bus/Mains minimum kW level1
7	4303	Bus/Mains under voltage level2
6	4303	Bus/Mains under voltage level1
5	4302	Bus/Mains over voltage level2
4	4302	Bus/Mains over voltage level1
3	4301	Bus/Mains under frequency level 2
2	4301	Bus/Mains under frequency level1
1	4300	Bus/Mains over frequency level2
0	4300	Bus/Mains over frequency level1

E00968 (Alarm)		
Bit	Var	Description
15	661	J1939 : DM1 malfunction
14	660	J1939 : DM1 red
13	659	J1939 : DM1 amber
12	658	J1939 : DM1 protect
11	657	J1939 : High overspeed
10	656	J1939 : Overspeed
9	655	J1939 : Very low oil pressure
8	654	J1939 : Low oil pressure
7	653	J1939 : Very high coolant temepature
6	652	J1939 : High coolant temepature
5	4311	Df/dt (Rocof)
4	4310	Vector jump
3	4309	Bus/Mains reverse kVAR level2
2	4309	Bus/Mains reverse kVAR level1
1	4308	Bus/Mains maximum kVAR level2
0	4308	Bus/Mains maximum kVAR level1

E00969 (Fault)		
Bit	Var	Description
15	661	J1939 : DM1 malfunction
14	660	J1939 : DM1 red
13	659	J1939 : DM1 amber
12	658	J1939 : DM1 protect
11	657	J1939 : High overspeed
10	656	J1939 : Overspeed
9	655	J1939 : Very low oil pressure
8	654	J1939 : Low oil pressure
7	653	J1939 : Very high coolant temeprature
6	652	J1939 : High coolant temeprature
5	4311	Df/dt (Rocof)
4	4310	Vector jump
3	4309	Bus/Mains reverse kVAR level2
2	4309	Bus/Mains reverse kVAR level1
1	4308	Bus/Mains maximum kVAR level2
0	4308	Bus/Mains maximum kVAR level1

E00970 (Alarm)		
Bit	Var	Description
15	4478	Fail to stabilize voltage
14	4477	Fail to stabilize speed
13	4170	Generator breaker close suddently
12	4156	Generator breaker open suddently
11	4155	Fail to open generator breaker
10	4154	Fail to close generator breaker
9	4208	Minimum/maximum analog measure 3 (level2)
8	4208	Minimum/maximum analog measure 3 (level1)
7	4207	Minimum/maximum analog measure 2 (level2)
6	4207	Minimum/maximum analog measure 2 (level1)
5	4206	Minimum/maximum analog measure 1 (level2)
4	4206	Minimum/maximum analog measure 1 (level1)
3	-	-
2	600	CAN1 isolated product
1	77	Phase mesure discordance
0	4051	Fail to synchronize

E00971 (Fault)		
Bit	Var	Description
15	-	-
14	-	-
13	4170	Generator breaker close suddently
12	4156	Generator breaker open suddently
11	4155	Fail to open generator breaker
10	4154	Fail to close generator breaker
9	4208	Minimum/maximum analog measure 3 (level2)
8	4208	Minimum/maximum analog measure 3 (level1)
7	4207	Minimum/maximum analog measure 2 (level2)
6	4207	Minimum/maximum analog measure 2 (level1)
5	4206	Minimum/maximum analog measure 1 (level2)
4	4206	Minimum/maximum analog measure 1 (level1)
3	-	-
2	600	CAN1 isolated product
1	77	Phase mesure discordance
0	4051	Fail to synchronize

E00972 (Alarm)		
Bit	Var	Description
15	-	-
14	859	Maintenance days n°5
13	858	Maintenance days n°4
12	857	Maintenance days n°3
11	856	Maintenance days n°2
10	855	Maintenance days n°1
9	854	Maintenance hours n°5
8	853	Maintenance hours n°4
7	852	Maintenance hours n°3
6	851	Maintenance hours n°2
5	850	Maintenance hours n°1
4	19	Overload microcontroler
3	4108	Trip alarm (non essential load)
2	4153	Breaker alarm
1	650	J1939 alarm
0	4750	CANopen alarm

E00973 (Fault)		
Bit	Var	Description
15	-	-
14	-	-
13	-	-
12	-	-
11	-	-
10	-	-
9	650	J1939 fault
8	4750	CANopen fault
7	4152	Breaker fault
6	4451	Sensor lost
5	4475	Fail to start
4	4473	Generator not ready
3	4472	Fail to stop
2	4505	Emergency stop
1	4504	Coolant temperature fault
0	4503	Oil pressure fault

E00974 (Alarm)		
Bit	Var	Description
15	607	CAN1 mismatch protocole version
14		CAN1 not enough GE
13	605	CAN1 missing product
12	4212	Maximum AVR output
11	4211	Minimum AVR output
10	4210	Maximum speed output
9	4209	Minimum speed output
8	4213	Overflow in equation
7	4314	Mains voltage unbalance (level2)
6	4314	Mains voltage unbalance (level1)
5	4269	Generator current unbalance (level2)
4	4269	Generator current unbalance (level1)
3	4268	Generator/bus voltage unbalance (level2)
2	4268	Generator/bus voltage unbalance (level1)
1	4316	Bus measure error
0	608	CAN1 missing MASTER

E00975 (Fault)		
Bit	Var	Description
15	-	-
14	606	CAN1 unknown product
13	605	CAN1 missing product
12	4212	Maximum AVR output
11	4211	Minimum AVR output
10	4210	Maximum speed output
9	4209	Minimum speed output
8	-	-
7	4314	Mains voltage unbalance (level2)
6	4314	Mains voltage unbalance (level1)
5	4269	Generator current unbalance (level2)
4	4269	Generator current unbalance (level1)
3	4268	Generator/bus voltage unbalance (level2)
2	4268	Generator/bus voltage unbalance (level1)
1	-	-
0	608	CAN1 missing MASTER

CRE TECHNOLOGY

Based in Sophia Antipolis, **CRE TECHNOLOGY** is a French manufacturer, ISO 9001 certified, employs nearly 25 employees, all experts in their field.

CRE TECHNOLOGY offers electronic products and electrical solutions dedicated to the control and the protection of industrial and marine generators: battery chargers, Generator sets controllers and synchronizing and paralleling equipments.

We are known for our skills, expertise and value-added solutions but also highly appreciated for our pre/after sales services.

CRE TECHNOLOGY's product development is focused on innovation.

The key to our strategy is the availability of our products with a large stock capacity.

Our company is highly recognized for technical achievements with over 1500 paralleling solutions sold each year, 35 years of experience, and partners in 27 countries.

10% of our annual turnover is reinvested in R&D and we offer 7 new products per year and have the best flexibility/price ratio on the market.

The next few years will see the expansion of our distribution network and our innovative product portfolio.



A WORLDWIDE DISTRIBUTION NETWORK

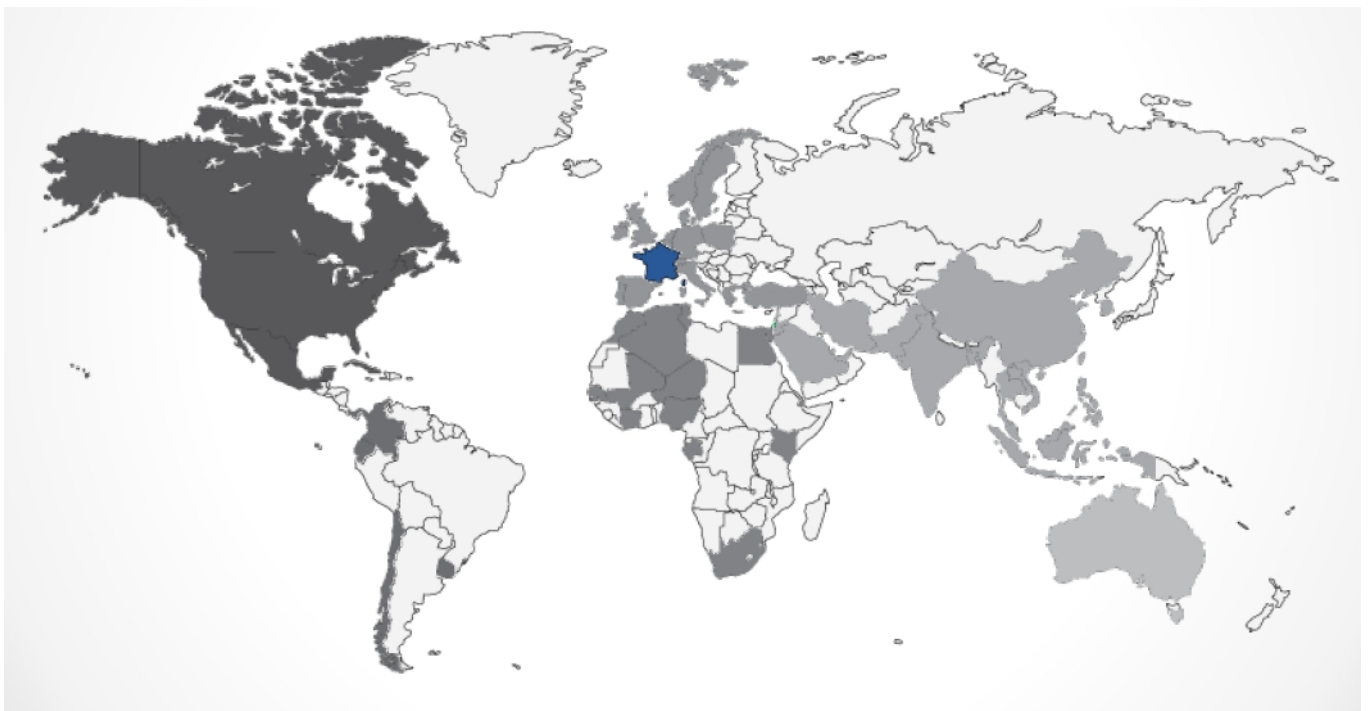

Consult the complete list of our worldwide distributors on our website <https://www.cretechnology.com/en/cre-distributors>.

THE COMPANY AT A GLANCE

1983

CRE TECHNOLOGY is born. At the time, the company is a custom-product manufacturer. We enlarge our product range and services to high standard technical units, particularly in the paralleling sector. Today with 35 years of experience, this custom expertise and our passion for technical challenges are still the company's best assets.

2002

GENSYS is launched. It will become **CRE TECHNOLOGY**'s best-seller and the basis of its notoriety. Today, **CRE TECHNOLOGY** provides 3000 paralleling solutions each year. Most of them are ordered directly by OEMs which appreciate our technical efficiency.

2006

CRE TECHNOLOGY, a member of the **DSF** Engineering and Distribution Generator, becomes independent from **DSF** Technologies. The company realizes its ambitions: to develop new ranges and expand its distribution network. **CRE TECHNOLOGY** now provides an extensive range of products in the genset control and paralleling market. Its worldwide network grows continuously, covering lots of new countries every year. **CRE TECHNOLOGY** now provides an extensive range of products in the genset control and paralleling market.

2009

CRE TECHNOLOGY is ISO 9001 certified with the 2008 version. DNV certification is added to the other **GENSYS MARINE** approvals: Lloyds and BV.

2010

CRE TECHNOLOGY diversifies its ranges of products by introducing a wide range of battery chargers within its range.

2012

CRE TECHNOLOGY keeps developing new products in accordance with the market. The paralleling range now includes the **GENSYS 2.0** core and the RDM 2.0, as well as the marine range with the **GENSYS 2.0 MARINE** (DNV approved).

2015

The new **GENSYS COMPACT** is in the range, and fully available for success, Lloyds Register marine approvals on **GENSYS2.0** marine, with the existing DNV-GL marine approval.

2017

The new **UNIGEN 2.0** has been added to the range, to extend our offer on parallel and solutions. The global range is constantly improved with a new PLC Solutions in order to customize even more our outcomes. A new **AVR COMPACT** is being added to our catalog to extend our capabilities.

TOMORROW

New products, new members in the distribution network, and new exciting projects to build and win with you!

CONTACTS

Postal address:

130 allée Charles-Victor Naudin
Zone des Templiers
Sophia-Antipolis
06410 BIOT
FRANCE

Phone: +33 (0)4 92 38 86 82

Fax: +33 (0)4 92 38 86 83

Web site: <http://www.cretechnology.com>

Email: info@cretechnology.com

Technical support:

Phone: +33 (0)4 92 38 86 86 (8H30 – 12H00 / 14H00 – 18H00 GMT +1)

Email: support@cretechnology.com

Skype: support-cretechnology.com (Spoken only)

Follow us on:

